

COMMERCIAL RAILINGS



DekPro™ Prestige

Textured Aluminum Railing System pg 84 - 91

Fortress® AI13+

Aluminum Railing System pg 92 - 98

DekPro™ Prestige Railing Overview



Use the steps below for the following pages to complete your rail.

STEP 1 Choose Rail Kits
Level or Stair. Comes complete with all brackets and screws

STEP 2 Choose Post
3" Posts include Caps, Skirts & Shims.

DekPro™ Prestige Aluminum Railing System

DekPro™ Prestige railing system features a durable, finely textured powder coat finish available in four popular colors. With it's sleek, stylish top rail design, this rail compliments any home. Made from all aluminum components DekPro™ Prestige is virtually maintenance free and includes a 20 Year Warranty.

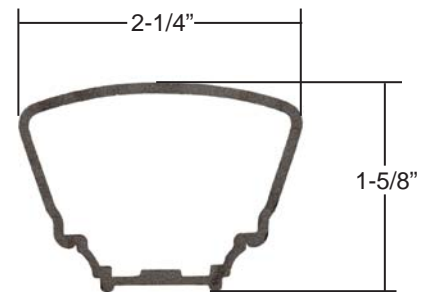

Top Rail Profile

ACTUAL FREIGHT CHARGES APPLY TO DEKPRO™ PRESTIGE RAIL ORDERS



Dekpro™ Prestige Rail - Absolute Black

DekPro™ Prestige Level Railing (Textured)



Level Kit Includes:

- A. 1 - 1-3/4" x 2-1/4" Architectural Top Rail w/ Baluster Connectors Installed
- B. 1 - 1-1/4" x 1-1/4" Bottom Rail w/ Baluster Connectors Installed
- C. Square 3/4" Balusters:
15 per 6' kit • 21 per 8' kit
- D. 2 - Top Rail Brackets - Level
- E. 2 - Bottom Rail Brackets - Level
- F. 1 - Rail Support - Surface Mount
- G. T30 Torx Self-drilling Screws Included

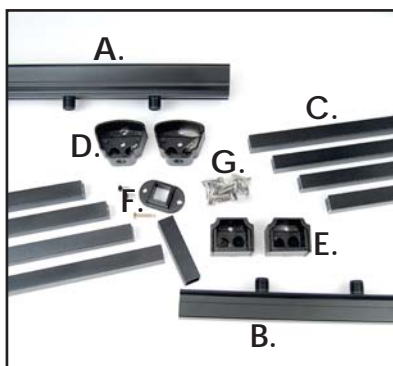

Level Aluminum Rail Kits - Square Balusters

Sold in any quantity.

Textured aluminum level railing comes complete with top and bottom lineals (baluster connectors installed), square balusters, brackets and rail support. Simply cut upper and lower rails to length, position balusters in place and install. 36" balusters used for 42" rail. **Brackets add a total of 1/2" to overall railing length.**

6' Rail Kits - 70"

42" Rail Height (39" x 70")

- Item # PR4272SLABT - Absolute Black
- Item # PR4272SLCBT - Cocoa Bronze
- Item # PR4272SLDWT - Dream White
- Item # PR4272SLMCT - Maple Cream

8' Rail Kits - 96-3/4"

42" Rail Height (39" x 96-3/4")

- Item # PR4296SLABT - Absolute Black
- Item # PR4296SLCBT - Cocoa Bronze
- Item # PR4296SLDWT - Dream White
- Item # PR4296SLMCT - Maple Cream

Available Textured Finishes:



Absolute Black (ABT)



Dream White (DWT)



Cocoa Bronze (CBT)

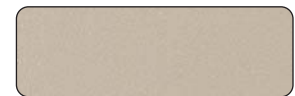

Maple Cream (MCT)

*Colors shown are an approximate representation.
 Please see actual product sample when selecting color.*

ACTUAL FREIGHT CHARGES APPLY TO DEKPRO™ PRESTIGE RAIL ORDERS

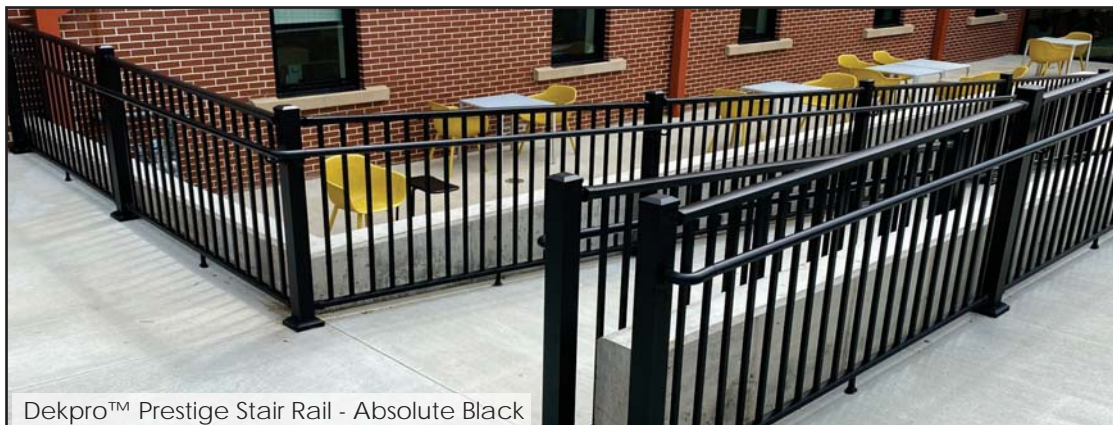

Dekpro™ Prestige Stair Rail - Absolute Black

DekPro™ Prestige Adjustable Stair Railing (Textured)

Stair Aluminum Rail Kits - Rackable to 40°

Sold in any quantity.

Textured aluminum adjustable stair railing comes complete with top and bottom lineals (pre-slotted to accept balusters), square balusters and brackets. Simply cut upper and lower rails to length, position balusters in place and install. 38" balusters used for 42" rail.



Stair Kit Includes:

- A. 1 - 1-3/4" x 2-1/4" Architectural Top Rail pre-slotted to accept balusters
- B. 1 - 1-1/4" x 1-1/4" Bottom Rail pre-slotted to accept balusters
- C. Square 3/4" Balusters: 15 per 6' kit • 21 per 8' kit
- D. 2 - Top Rail Brackets - Stair
- E. 2 - Bottom Rail Brackets - Stair
- F. T30 Torx Self-drilling Screws Included

6' Stair Rail Kits - 70"

42" Rail Height (38-5/8" x 70")

- Item # PR4272SRSABT - Absolute Black
- Item # PR4272SRSCBT - Cocoa Bronze
- Item # PR4272SRSDWT - Dream White
- Item # PR4272SRSMCT - Maple Cream

8' Stair Rail Kits - 96-3/4"

42" Rail Height (38-5/8" x 96-3/4")

- Item # PR4296SRSABT - Absolute Black
- Item # PR4296SRSCBT - Cocoa Bronze
- Item # PR4296SRSDWT - Dream White
- Item # PR4296SRSMCT - Maple Cream

Available Textured Finishes:

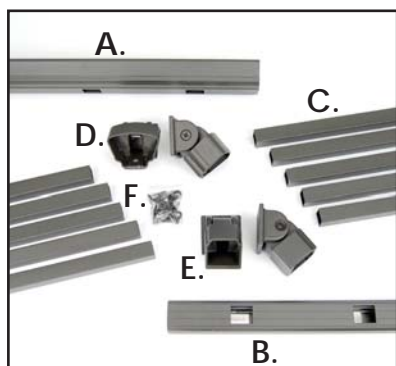

Absolute Black (ABT)



Dream White (DWT)



Cocoa Bronze (CBT)



Maple Cream (MCT)

Colors shown are an approximate representation. Please see actual product sample when selecting color.

ACTUAL FREIGHT CHARGES APPLY TO DEKPROTM PRESTIGE RAIL ORDERS

DekProTM Prestige Posts and Post Sleeves (Textured)

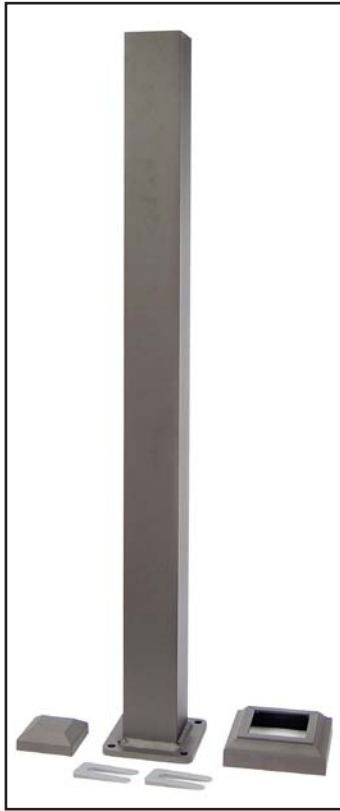

Available in:

-  Absolute Black
-  Cocoa Bronze
-  Dream White
-  Maple Cream

3" Commercial Post w/ Post Cap and Skirt

Sold in any quantity.

3" Aluminum post with 5" welded flange. Base plate is 1/2" thick with 3/8" holes spaced 4" on center for fasteners. Post skirt measure 5-3/8".
Post cap and 2 piece skirt & tapered shims included.

3" x 44"

- Item # **PRCOMM3044ABT** - Absolute Black
- Item # **PRCOMM3044CBT** - Cocoa Bronze
- Item # **PRCOMM3044DWT** - Dream White
- Item # **PRCOMM3044MCT** - Maple Cream

3" x 54"

- Item # **PRCOMM3054ABT** - Absolute Black
- Item # **PRCOMM3054CBT** - Cocoa Bronze
- Item # **PRCOMM3054DWT** - Dream White
- Item # **PRCOMM3054MCT** - Maple Cream

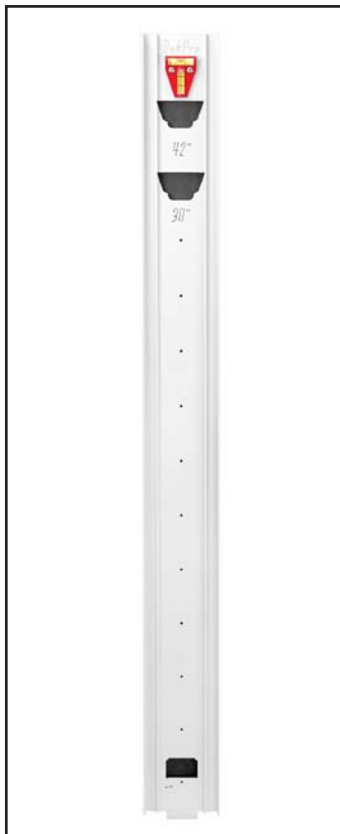

Available in:

-  White

Quick Jig Rail Guide - For Level Railing

Sold in any quantity.

Quick Jig rail guide allows the installer to easily locate and fasten rail brackets to the post for level railing without having to measure or center brackets manually. Quick jig can also be used to plumb posts using the attached 2 way level.

Item # **PRJIG3C** - Quick Jig for 3" Post



ACTUAL FREIGHT CHARGES APPLY TO DEKPRO™ PRESTIGE RAIL ORDERS



- Available in:
- Absolute Black
 - Cocoa Bronze
 - Dream White
 - Maple Cream

Level Rail Bracket Cut Kit

Sold in any quantity.

2 top rail brackets, 2 bottom rail brackets and 1 support block kit. Used for level rail to post attachment. Includes screws.

- Item # PRLBCUTKITABT - Absolute Black
- Item # PRLBCUTKITCBT - Cocoa Bronze
- Item # PRLBCUTKITDWT - Dream White
- Item # PRLBCUTKITMCT - Maple Cream



- Available in:
- Absolute Black
 - Cocoa Bronze
 - Dream White
 - Maple Cream

Multi-Angle Rail Bracket Cut Kit

Sold in any quantity.

2 top rail brackets, 2 bottom rail brackets and 1 support block kit. Used for side to side angle rail to post attachment. Adjustable up to a 53 degree angle. Includes screws.

- Item # PRMABCUTKITABT - Absolute Black
- Item # PRMABCUTKITCBT - Cocoa Bronze
- Item # PRMABCUTKITDWT - Dream White
- Item # PRMABCUTKITMCT - Maple Cream



- Available in:
- Absolute Black
 - Cocoa Bronze
 - Dream White
 - Maple Cream

Adjustable Stair Rail Bracket Cut Kit

Sold in any quantity.

2 top and 2 bottom rail brackets. Used for adjustable stair rail to post attachment. Adjustable up to a 40 degree angle. Includes screws.

- Item # PRSBCUTKITABT - Absolute Black
- Item # PRSBCUTKITCBT - Cocoa Bronze
- Item # PRSBCUTKITDWT - Dream White
- Item # PRSBCUTKITMCT - Maple Cream



- Available in:
- Absolute Black
 - Cocoa Bronze
 - Dream White
 - Maple Cream

Prestige Touch Up Paint

Sold in any quantity.

Sold in 11 oz. spray can to touch up rails.

Spray Can (11 oz):

- Item # PRPAINT12ABT - Black
- Item # PRPAINT12CBT - Bronze
- Item # PRPAINT12DWT - White
- Item # PRPAINT12MCT - Cream

ACTUAL FREIGHT CHARGES APPLY TO DEKPRO™ PRESTIGE RAIL ORDERS

DekPro™ Prestige Gate Kits (Textured)

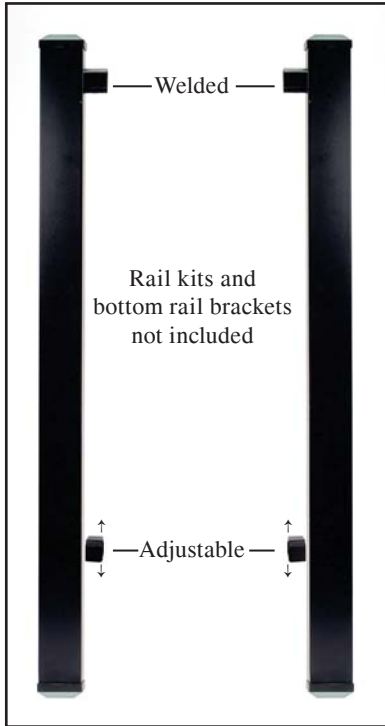

Available in:

- Absolute Black
- Cocoa Bronze
- Dream White
- Maple Cream

44" Gate Upright Kit

2 uprights per kit.

3" x 44" Gate uprights come with upper brackets welded for durability. Lower brackets can be adjusted to meet the location of your lower rail when used with either 36" or 42" rail sections. Bottom brackets are included in the railing kits, not included with gate uprights. Can be trimmed to length at the bottom and capped with 4 caps included. **(Rail Section, latch and hinges must be purchased separately)**

- Item # PRGATEKITABT - Absolute Black
- Item # PRGATEKITCBT - Cocoa Bronze
- Item # PRGATEKITDWT - Dream White
- Item # PRGATEKITMCT - Maple Cream

Requires separate purchase of railing section (Pg. 85) and associated accessories.



Available in:

- Black
- White

Gate Hinge Set with 1" Legs

Sold in pairs.

Self closing tension adjustable, Nylon gate hinges with 1" legs. Maximum self-closing weight of 55 lbs. Includes screws.

- Item #: BLACKNYLHINGE - Black
- Item #: WHITENYLHINGE - White



Available in:

- Black
- White

Gate Latch

Sold in any quantity.

A quality and affordable latch for general-purpose gates. Combines the unique benefits of key-lockability and reliable latching action with superior design and rust proof components. Fits square posts. Includes screws.

- Item #: BLACKLATCH - Black
- Item #: WHITELATCH - White



ACTUAL FREIGHT CHARGES APPLY TO DEKPRO™ PRESTIGE RAIL ORDERS



Available in:
Stainless Steel

Optional Gate Anti-Sag Kit

2 uprights per kit.

Recommended for use with Prestige gate kits. Simply drill 29/64" hole through each post and attach cable. Cable can be trimmed on site and is adjustable to prevent gate sag over time.

Item # 25205 - 5' Cable Kit

Item # 29/64DRILL - 29/64" Drill Bit

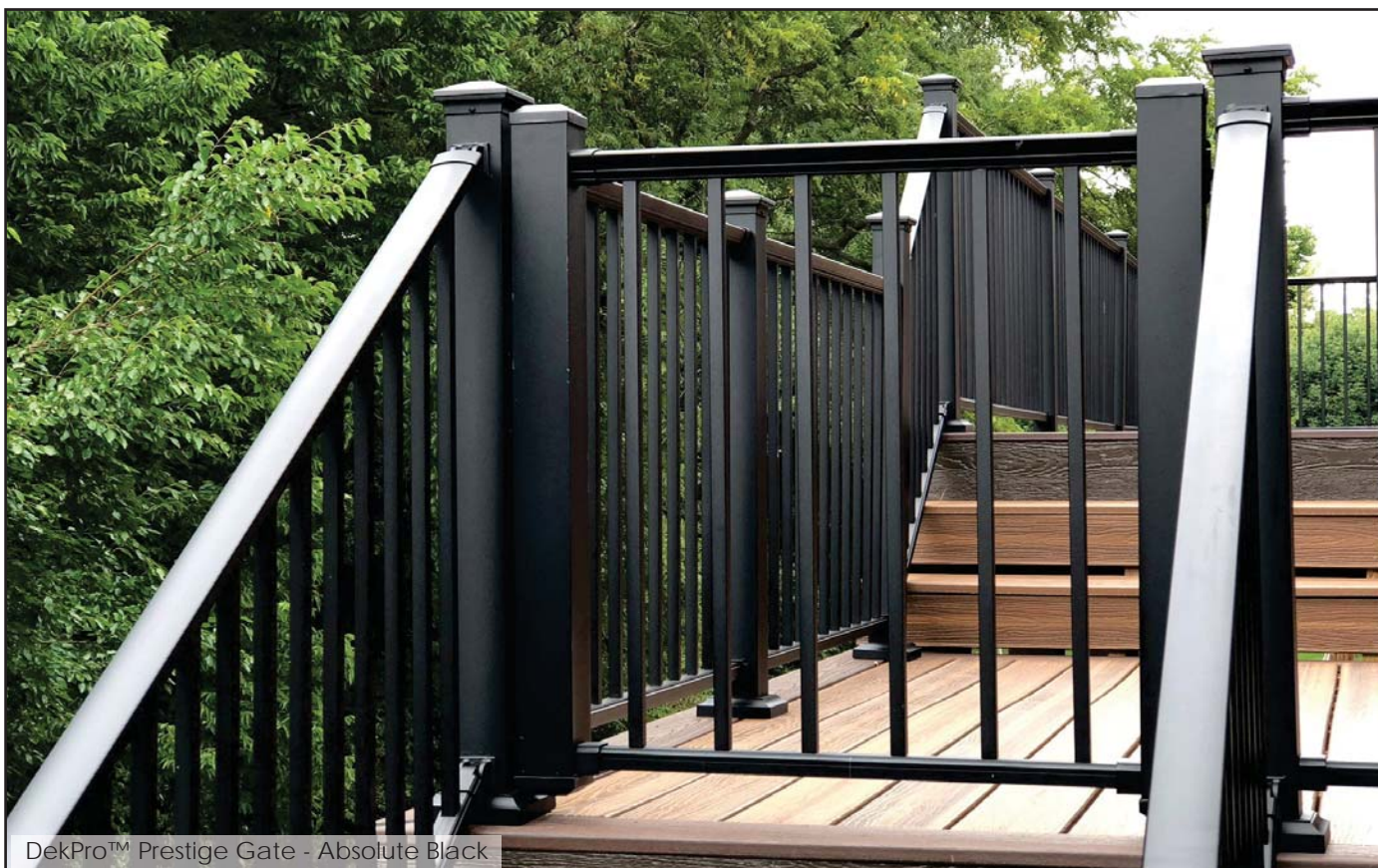
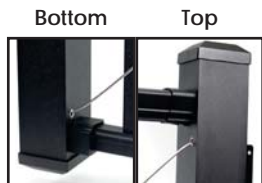

ACTUAL FREIGHT CHARGES APPLY TO DEKPROTM PRESTIGE RAIL ORDERS

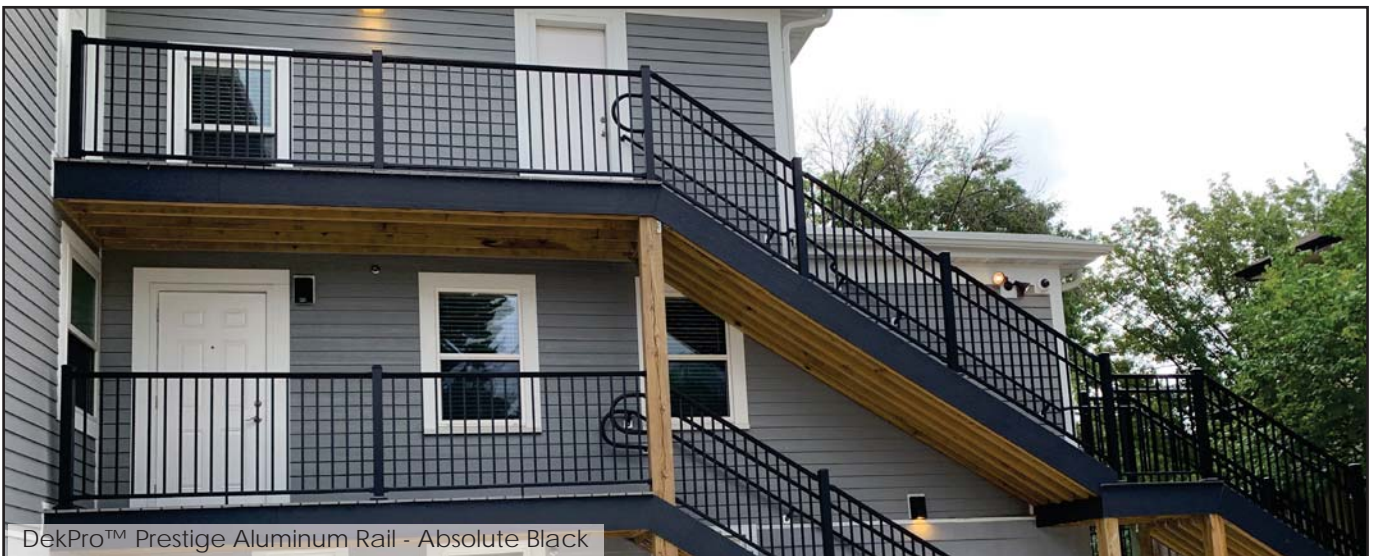
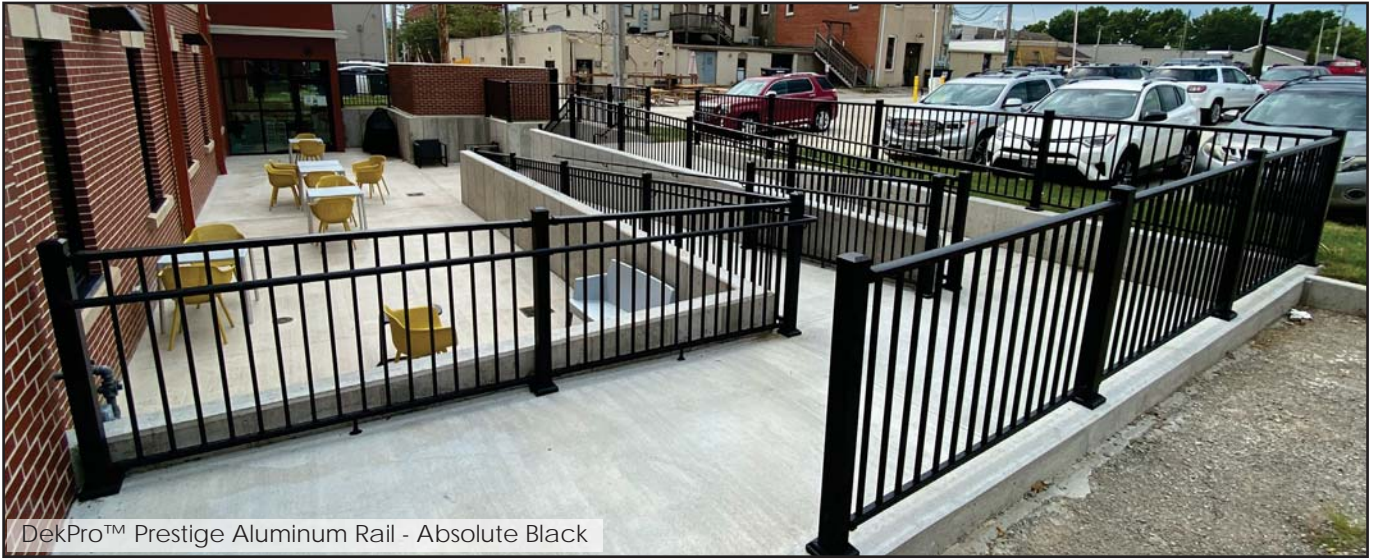

Fortress® AL13+ Railing Overview



Use the steps below for the following pages to complete your rail

STEP 1 Choose Panel

STEP 3 Choose post
Surface or Fascia Mount

STEP 2 Choose Brackets (4 Pack)

STEP 4 Select a Post Cap

Fortress® Aluminum Railing System

Fortress AL13+ railing system features fully pre-welded aluminum rails, distinctly different from aluminum kits. Panels install easily with a simple bracket system. Aluminum construction and a premium powder coating create a virtually maintenance free system designed for use in a variety of environments. Rail panels can be used as a complete system or they can be installed between existing posts.

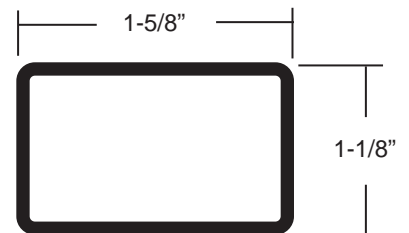

Top Rail Profile

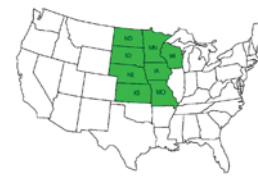

ACTUAL FREIGHT CHARGES APPLY TO FORTRESS® RAIL ORDERS



Fortress® Aluminum Rail - White

Fortress® Al¹³⁺ Welded Aluminum Panels



Top / bottom rail measure 1-5/8" x 1" and Infill balusters are 3/4" square for both level and stair panels.

Available in:

- White
- Black Sand
- Gloss Black

6' - Al¹³⁺ Traditional Aluminum Panel

Sold in any quantity

40" x 69" Fortress Al¹³⁺ welded aluminum panel achieves a total railing height of 42." Brackets sold separately, see next page.

42" Rail Height (40" x 69" Panel)

- Item # **51140691** - White
- Item # **51140698** - Black Sand (Txt)
- Item # **51140690** - Gloss Black

Fortress® Al¹³⁺ Adjustable Aluminum Stair Panels

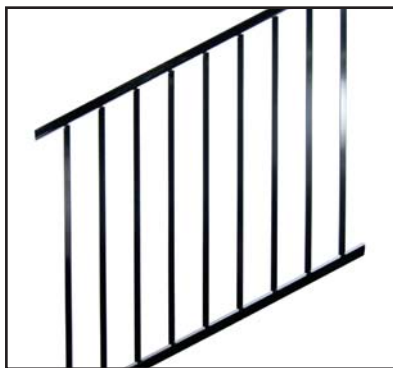

Available in:

- White
- Black Sand
- Gloss Black

6' - Al¹³⁺ Aluminum Adjustable Stair Panel

Sold in any quantity

Fortress Al¹³⁺ aluminum panel for stairs and ramps, achieves a total railing height of 42". Panel adjustable from 5° - 45°. Brackets sold separately, see next page.

42" Rail Height (40" x 69" Panel)

- Item # **51240721** - White
- Item # **51240728** - Black Sand (Txt)
- Item # **51240720** - Gloss Black

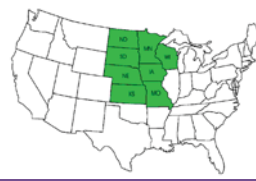

ACTUAL FREIGHT CHARGES APPLY TO FORTRESS® RAIL ORDERS

Fortress® AI¹³⁺ Rail Brackets



Available in:

- White
- Black Sand
- Gloss Black

AI¹³⁺ Evolve External Bracket - Level

Sold in bags of 4.

Top and bottom rails drop into brackets for level / straight applications with a cap to cover for a finished look. Includes screws for wood and metal applications.

- Item # 51500211 - White
- Item # 51500218 - Black Sand (Textured)
- Item # 51500210 - Gloss Black



Available in:

- White
- Black Sand
- Gloss Black

AI¹³⁺ Evolve External Bracket - Stair

Sold in bags of 4.

Top and bottom rails drop into brackets for stair applications with a cap to cover for a finished look. Adjustable up to a 55 degree angle. Includes screws for wood and metal applications.

- Item # 51500311 - White
- Item # 51500318 - Black Sand (Textured)
- Item # 51500310 - Gloss Black



Available in:

- White
- Black Sand
- Gloss Black

AI¹³⁺ Evolve External Bracket - Angle / Miter

Sold in bags of 4.

Top and bottom rails drop into brackets for level angle/miter applications with a cap to cover for a finished look. Adjustable up to a 45 degree angle. Includes screws for wood and metal applications.

- Item # 51500411 - White
- Item # 51500418 - Black Sand (Textured)
- Item # 51500410 - Gloss Black



White

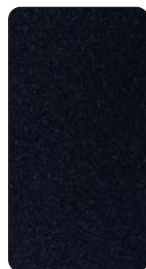

Black Sand



Gloss Black

Colors shown are an approximate representation only, please see actual product sample when selecting color

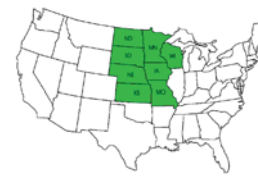

ACTUAL FREIGHT CHARGES APPLY TO FORTRESS® RAIL ORDERS

Fortress® AI¹³⁺ Posts, Caps & Skirts

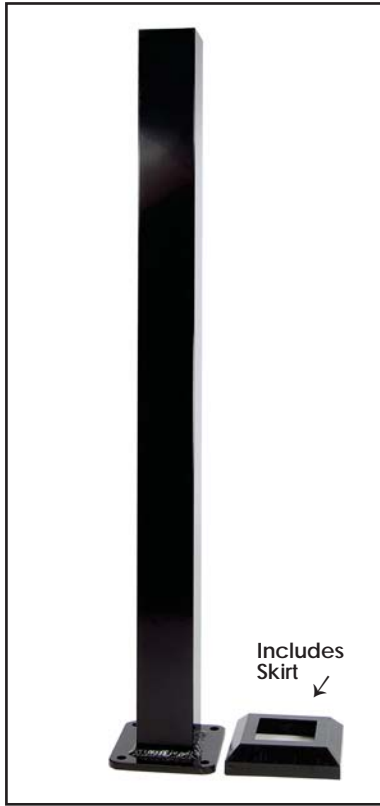

Available in:

- White
- Black Sand
- Gloss Black

AI¹³⁺ Aluminum 3" Post with 2 pc. Skirt

Sold in any quantity.

3" x 45-1/2" Aluminum post with 5-1/2" flange and skirt to install panels at a 42" railing height. Flange holes are 1/2" for fasteners. **Includes skirt for base.**

- Item # **51345031** - White
- Item # **51345038** - Black Sand (Textured)
- Item # **51345030** - Gloss Black

3" x 55" Aluminum post with 5-1/2" flange and skirt for stair panels at a 42" railing height. Flange holes are 1/2" for fasteners. **Includes skirt for base.**

- Item # **51355031** - White
- Item # **51355038** - Black Sand (Textured)
- Item # **51355030** - Gloss Black



FortressAccents 3" Post Cap

Sold in any quantity.

Accents flat die cast aluminum post cap for 3" post.

- Item # **52500031** - White
- Item # **52500038** - Black Sand (Textured)
- Item # **52500030** - Gloss Black

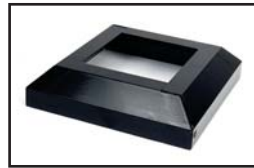

3" Post Skirt 2 pc. - Replacement

Sold in any quantity.

AI¹³⁺ - 5-3/4" Post base cover included. Also sold separately. Measures 5-3/4" x 1-1/2" with 3-1/8" opening.

- Item # **51500031** - White
- Item # **51500038** - Black Sand (Textured)
- Item # **51500030** - Gloss Black

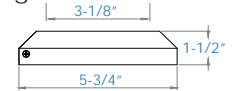

Available in:

- White
- Black Sand
- Gloss Black

AI¹³⁺ - 3" Aluminum Fascia Mount Post

Sold in any quantity.

3" x 55" Aluminum post used to install panels at a 42" rail height for a fascia mount application. **Requires fascia mount brackets, see next page.**

3" x 55" Post

- Item # **51355021** - White
- Item # **51355028** - Black Sand (Textured)
- Item # **51355020** - Gloss Black



FortressAccents 3" Post Cap

Sold in any quantity.

Accents flat die cast aluminum post cap for 3" post.

- Item # **52500031** - White
- Item # **52500038** - Black Sand (Textured)
- Item # **52500030** - Gloss Black

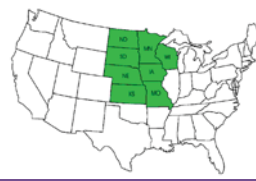

ACTUAL FREIGHT CHARGES APPLY TO FORTRESS® RAIL ORDERS

Fortress® AI¹³⁺ Fascia Brackets



Available in:

- White
- Black Sand
- Gloss Black

Fascia Mount Bracket

Sold in any quantity.

Fascia mount bracket for 3" posts. Bracket offsets post 1/4" out from fascia. Includes 4 self-drilling screws & 4 hex head bolt covers. Mounting hardware not included.

3" Fascia Bracket

- Item # **53503001** - White
- Item # **53503008** - Black Sand (Textured)
- Item # **53503000** - Gloss Black



Available in:

- White
- Black Sand
- Gloss Black

Outside Corner Fascia Mount Bracket

Sold in any quantity.

Outside Corner fascia mount bracket for 3" posts. Bracket offsets post 1/4" out from fascia. Includes 4 self-drilling screws & 8 hex head bolt covers. Mounting hardware not included.

3" Outside Corner Fascia Bracket

- Item # **53503011** - White
- Item # **50503018** - Black Sand (Textured)
- Item # **50503010** - Gloss Black



Available in:

- White
- Black Sand
- Gloss Black

Inside Corner Fascia Mount Bracket

Sold in any quantity.

Inside Corner fascia mount bracket for 3" posts. Bracket offsets post 1/4" out from fascia. Includes 4 self-drilling screws & 4 hex head bolt covers. Mounting hardware not included.

3" Inside Corner Fascia Bracket

- Item # **53503021** - White
- Item # **53503028** - Black Sand (Textured)
- Item # **53503020** - Gloss Black



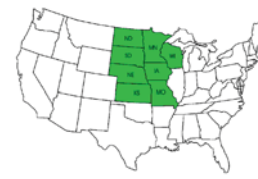

ACTUAL FREIGHT CHARGES APPLY TO FORTRESS® RAIL ORDERS

Fortress® AI¹³⁺ Posts, Caps & Skirts



Available in:

- White
- Black Sand
- Gloss Black

AI¹³⁺ Flat Pyramid Post Cap

Sold in any quantity.

AI¹³⁺ - 3" Flat pyramid cap.

- Item #: 51500041 - White
- Item #: 51500048 - Black Sand (Textured)
- Item #: 51500040 - Gloss Black



Available in:

- White
- Black Sand
- Gloss Black

AI¹³⁺ Aluminum Support Block

Sold in any quantity.

3-3/4" Support block provides additional support at mid-span of rail.

- Item # 55535001 - White
- Item # 55535008 - Black Sand (Textured)
- Item # 55535000 - Gloss Black



Available in:

- White
- Black Sand
- Gloss Black

AI¹³⁺ Aluminum Cap Rail Clip

Sold in bags of 4.

Clips allow for a clean, smooth attachment of wood or composite cap rails to the top of AI¹³⁺ panels. Clips are recommended every 2' along the rail. Includes screws.

- Item # 51500071 - White
- Item # 51500078 - Black Sand (Textured)
- Item # 51500070 - Gloss Black



Available in:

- White
- Black Sand
- Gloss Black

AI¹³⁺ Touch Up Paint

Sold in any quantity.

Available in two convenient sizes.

Spray Can

- Item # 660371 - White
- Item # 660378 - Black Sand
- Item # 660370 - Gloss Black

Paint Pen

- Item # 660361 - White
- Item # 660368 - Black Sand
- Item # 660360 - Gloss Black

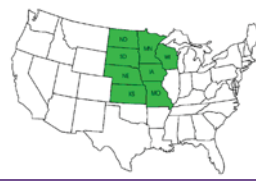

ACTUAL FREIGHT CHARGES APPLY TO FORTRESS® RAIL ORDERS

Fortress® AI¹³⁺ Gate Kits



Available in:

- White
- Black Sand
- Gloss Black

AI¹³⁺ Aluminum Gate Uprights

Sold in Pairs.

Fortress AI¹³⁺ welded Aluminum gate uprights. Simply trim panel to size (not included), then install uprights and secure. **Rail panel, hinges and latch sold separately.**

42" Rail Height (40")

- Item # **51540051** - White
- Item # **51540058** - Black Sand (Textured)
- Item # **51540050** - Gloss Black

Requires separate purchase of railing section (Pg. 93)

Ex: Completed Gate Kit



Available in:

- White
- Black

Gate Hinge Set with 1" Legs

Sold in pairs.

Self closing tension adjustable, Nylon gate hinges with 1" legs. Maximum self-closing weight of 55 lbs. Includes screws.

- Item #: WHITENYLHINGE - White
- Item #: BLACKNYLHINGE - Black



Available in:

- White
- Black

Gate Latch

Sold in any quantity.

A quality and affordable latch for general-purpose gates. Combines the unique benefits of key-lockability and reliable latching action with superior design and rust proof components. Fits square posts. Includes screws.

- Item #: WHITELATCH - White
- Item #: BLACKLATCH - Black



White



Black Sand



Gloss Black

Colors shown are an approximate representation only, please see actual product sample when selecting color

RED item numbers denote **NON STOCK** special order. Please allow for 3 week lead time.

SECONDARY HANDRAIL SYSTEMS



DekPro™ Prestige
Aluminum Textured
Secondary Handrail

pg 100 - 102

Fortress®
Secondary Handrail

pg 103 - 105

ACTUAL FREIGHT CHARGES APPLY TO DEKPROTM PRESTIGE RAIL ORDERS

1-1/2" DekProTM Prestige Round Aluminum Handrail - Textured

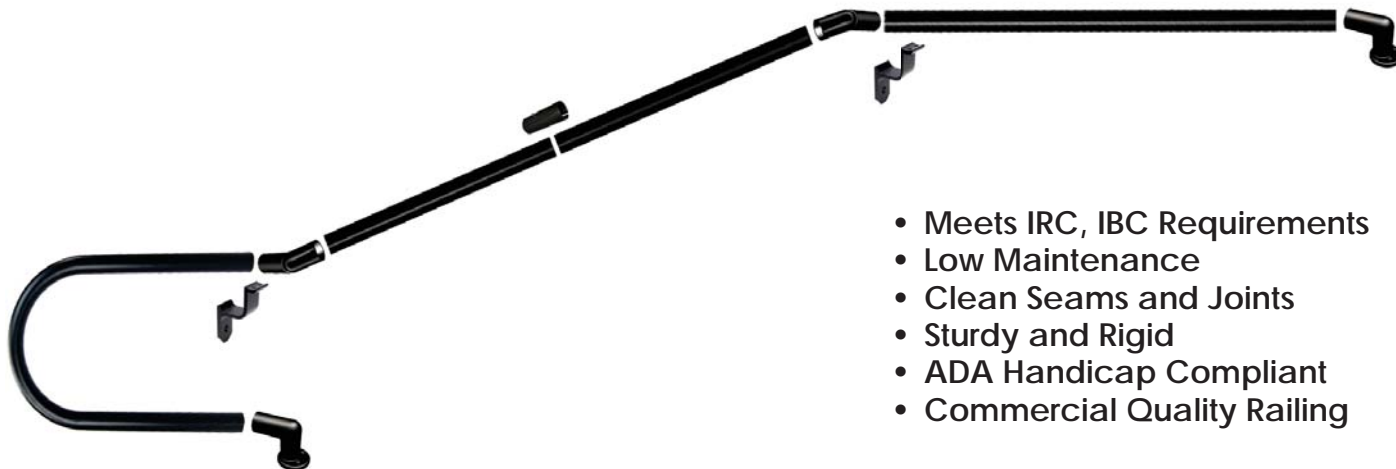

- Meets IRC, IBC Requirements
- Low Maintenance
- Clean Seams and Joints
- Sturdy and Rigid
- ADA Handicap Compliant
- Commercial Quality Railing

***DekProTM Prestige Secondary Handrail Features Four Finely TEXTURED Finishes**



- Available in:
- Absolute Black
 - Cocoa Bronze
 - Dream White
 - Maple Cream
 - Silver

96" & 92" - Straight Round Handrail

Sold in any quantity.

1-1/2" round graspable handrail meets IRC requirements for secondary handrail system. Installs with screws or adhesive. *92" rail saves on oversize shipping charges if shipping without pallet order.*

- | | |
|--------------------------------------|-----------------------------------|
| Item # PR1596SHRABT - Absolute Black | Item # PR1592SHRABT - Black |
| Item # PR1596SHRCBT - Cocoa Bronze | Item # PR1592SHRCBT - Bronze |
| Item # PR1596SHRDWT - Dream White | Item # PR1592SHRDWT - White |
| Item # PR1596SHRMCT - Maple Cream | Item # PR1592SHRMCT - Maple Cream |
| Item # PR1596SHRSILVER - Silver | Item # PR1592SHRSILVER - Silver |



- Available in:
- Absolute Black
 - Cocoa Bronze
 - Dream White
 - Maple Cream
 - Silver

Universal Quick Return Bracket Kit

Sold in any quantity.

Returns 1-1/2" round handrail into post or wall. Works for any surface 2" or wider. Includes a handrail splice kit to connect to rail and color matched screws. Installs with screws or adhesive.

- | |
|---------------------------------------|
| Item # PRSHRQRABTKIT - Absolute Black |
| Item # PRSHRQRBCBTKIT - Cocoa Bronze |
| Item # PRSHRQRDWTKIT - Dream White |
| Item # PRSHRQRMCTKIT - Maple Cream |
| Item # PRSHRQRSILVERKIT - Silver |



- Available in:
- Absolute Black
 - Cocoa Bronze
 - Dream White
 - Maple Cream
 - Silver

Universal Mid-Rail Bracket

Sold in any quantity.

Attaches 1-1/2" round handrail to post or wall. Includes color matched screws. Mounts to any flat surface 2" or wider. Adjustable to any angle.

- | |
|--------------------------------------|
| Item # PRSHMRBKTABT - Absolute Black |
| Item # PRSHMRBKTBCBT - Cocoa Bronze |
| Item # PRSHMRBKTBDWT - Dream White |
| Item # PRSHMRBKTBMCT - Maple Cream |
| Item # PRSHMRBKTBSILVER - Silver |



ACTUAL FREIGHT CHARGES APPLY TO DEKPRO™ PRESTIGE RAIL ORDERS



- Available in:
- Absolute Black
 - Cocoa Bronze
 - Dream White
 - Maple Cream
 - Silver

Wall Mount Bracket

Sold in any quantity.

Attaches 1-1/2" round handrail straight into post or wall. Works for any surface 3-1/2" or wider. Includes a handrail splice kit to connect to rail and color matched screws. Installs with screws or adhesive.

- Item # PRSHRWALLMTABT - Absolute Black
- Item # PRSHRWALLMTCBT - Cocoa Bronze
- Item # PRSHRWALLMTDWT - Dream White
- Item # PRSHRWALLMTMCT - Maple Cream
- Item # PRSHRWALLMTSIL - Silver



- Available in:
- Absolute Black
 - Cocoa Bronze
 - Dream White
 - Maple Cream
 - Silver

Handrail Splice Kit

Sold in any quantity.

Splice kit joins straight 1-1/2" round handrail sections. Kit includes 1 splice and 1 splice ring. Splice ring is used to conceal the connection point. Installs with screws or adhesive.

- Item # PRSHRSPLABTKIT - Absolute Black
- Item # PRSHRSPLCBTKIT - Cocoa Bronze
- Item # PRSHRSPLDWTKIT - Dream White
- Item # PRSHRSPLMCTKIT - Maple Cream
- Item # PRSHRSPLSILKIT - Silver



- Available in:
- Absolute Black
 - Cocoa Bronze
 - Dream White
 - Maple Cream
 - Silver

Multi-Angle Handrail Connector Kit

Sold in any quantity.

Connector kit joins 1-1/2" round handrail sections to allow for multi-angle connections to be made. Typically used for stair applications. Kit includes 1 multi-angle connector, 2 splices, and 2 splice rings. Installs with screws or adhesive.

- Item # PRSHRUABTKIT - Absolute Black
- Item # PRSHRUACBTKIT - Cocoa Bronze
- Item # PRSHRUADWTKIT - Dream White
- Item # PRSHRUAMCTKIT - Maple Cream
- Item # PRSHRUASILVERKIT - Silver



- Available in:
- Absolute Black
 - Cocoa Bronze
 - Dream White
 - Maple Cream
 - Silver

90° Elbow - Inside/Outside Corner

Sold in any quantity.

90 degree rail used for inside and outside corner applications. **Requires a straight handrail splice at each end. (Sold Separately).** Each side has 12" of rail. Installs with screws or adhesive.

- Item # PRSHRINSIDECABT - Absolute Black
- Item # PRSHRINSIDECGBT - Cocoa Bronze
- Item # PRSHRINSIDECDWT - Dream White
- Item # PRSHRINSIDECMCT - Maple Cream
- Item # PRSHRINSIDECSTL - Silver



- Available in:
- Absolute Black
 - Cocoa Bronze
 - Dream White
 - Maple Cream
 - Silver

Inside Corner Bracket

Sold in any quantity.

Attaches 1-1/2" round 90° elbow inside corner rail to corner of post. Includes color matched screws.

- Item # PRSHRISCBKTABT - Absolute Black
- Item # PRSHRISCBKTCBT - Cocoa Bronze
- Item # PRSHRISCBKTDWT - Dream White
- Item # PRSHRISCBKTMCT - Maple Cream
- Item # PRSHRISCBKTSIL - Silver



ACTUAL FREIGHT CHARGES APPLY TO DEKPRO™ PRESTIGE RAIL ORDERS



- Available in:
- Absolute Black
 - Cocoa Bronze
 - Dream White
 - Maple Cream
 - Silver

P-Loop Return - ADA Compliant

Sold in any quantity.

180 degree handrail end loop is used to extend beyond post and return back to post. **Requires a handrail splice and 2 brackets to complete installation.** Installs with screws or adhesive.

- Item # PRSHRPLOOPABT - Absolute Black
- Item # PRSHRPLOOPCBT - Cocoa Bronze
- Item # PRSHRPLOOPDWT - Dream White
- Item # PRSHRPLOOPMCT - Maple Cream
- Item # PRSHRPLOOPSILVER - Silver



- Available in:
- Absolute Black
 - Cocoa Bronze
 - Dream White
 - Maple Cream
 - Silver

End Cap

Sold in any quantity.

Finishes end of handrail if not attaching back to post. Installs with screws or adhesive.

- Item # PRSHRENDCAPABT - Absolute Black
- Item # PRSHRENDCAPCBT - Cocoa Bronze
- Item # PRSHRENDCAPDWT - Dream White
- Item # PRSHRENDCAPMCT - Maple Cream
- Item # PRSHRENDCAPSIL - Silver



- Available in:
- Absolute Black
 - Cocoa Bronze
 - Dream White
 - Maple Cream

Prestige Touch Up Paint

Sold in any quantity.

Sold in 11 oz. spray can to touch up rails.

Spray Can (11 oz):

- Item # PRPAINT12ABT - Black
- Item # PRPAINT12CBT - Bronze
- Item # PRPAINT12DWT - White
- Item # PRPAINT12MCT - Maple



Dekpro™ Prestige Secondary Handrail - Absolute Black

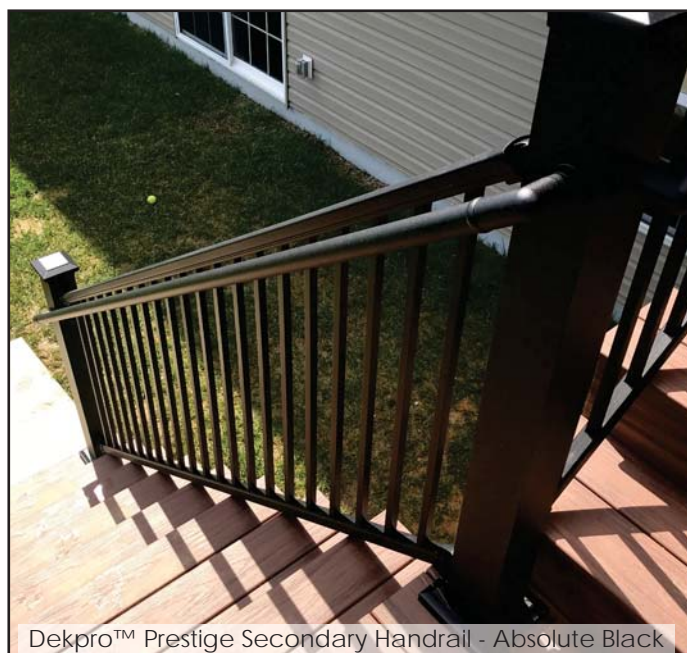

Dekpro™ Prestige Secondary Handrail - Absolute Black

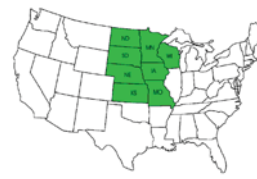

ACTUAL FREIGHT CHARGES APPLY TO FORTRESS® RAIL ORDERS

Fortress® 1-1/2" Round Handrail



Assemble secondary handrail using 2 part epoxy (No fasteners required)



Available in:

Black Sand

Ant. Bronze

White

8' - Fortress® Round Handrail

Sold in any quantity.

1-1/2 x 8' round graspable handrail meets IRC requirements for secondary handrail system.

Item # 50500948 - Black Sand (Textured)

Item # 50500946 - Antique Bronze

Item # 50500941 - White



Available in:

Black Sand

Ant. Bronze

White

Fortress® Round Handrail Return Bracket

Sold in any quantity.

Returns 1-1/2" round handrail into post or wall. Works for any surface 2" or more. **Requires a straight handrail splice to connect to handrail (see next page).** Includes color matched screws.

Item # 50500958 - Black Sand (Textured)

Item # 50500956 - Antique Bronze

Item # 50500951 - White



Available in:

Black Sand

Ant. Bronze

White

Fortress® Round Mid-Rail Bracket

2/Pack

Attaches 1-1/2" round handrail to post or wall. Includes color matched screws for wood and metal. Sold as pair.

Item # 50500918 - Black Sand (Textured)

Item # 50500916 - Antique Bronze

Item # 50500911 - White

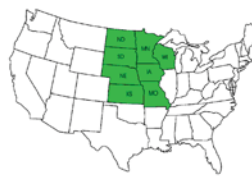

ACTUAL FREIGHT CHARGES APPLY TO FORTRESS® RAIL ORDERS



- Available in:
- Black Sand
 - Ant. Bronze
 - White

Fortress® Round Handrail Splice

Sold in any quantity.

Splice Joins 1-1/2" round handrail sections. Middle trim ring conceals splice. No hardware required, use 2 part epoxy for installation.

- Item # 50500978 - Black Sand (Textured)
- Item # 50500976 - Antique Bronze
- Item # 50500971 - White



- Available in:
- Black Sand
 - Ant. Bronze
 - White

Fortress® Round Handrail Angle Adjuster

Sold in any quantity.

Angle adjuster may be used to adjust to appropriate stair angle. No hardware required, use 2 part epoxy for installation.

- Item # 50501038 - Black Sand (Textured)
- Item # 50501036 - Antique Bronze
- Item # 50501031 - White



- Available in:
- Black Sand
 - Ant. Bronze
 - White

Fortress® Round Handrail 90° Elbow

Sold in any quantity.

90 Degree corner used to transition around post, must use handrail splice to attach to handrail. No hardware required, use 2 part epoxy for installation.

- Item # 50500928 - Black Sand (Textured)
- Item # 50500926 - Antique Bronze
- Item # 50500921 - White



- Available in:
- Black Sand
 - Ant. Bronze
 - White

Fortress® Round Handrail Corner Bracket

Sold in any quantity.

Attaches 1-1/2" round handrail to corner of post. Includes color matched screws.

- Item # 50500968 - Black Sand (Textured)
- Item # 50500966 - Antique Bronze
- Item # 50500961 - White



- Available in:
- Black Sand
 - Ant. Bronze
 - White

Fortress® Round Handrail P-Loop

Sold in any quantity.

180 Degree Handrail end loop is used to extend beyond post and return back to post. Handrail splice, mid rail bracket, and return bracket are required to complete installation. No hardware required, use 2 part epoxy for installation.

- Item # 50501928 - Black Sand (Textured)
- Item # 50501926 - Antique Bronze
- Item # 50501921 - White



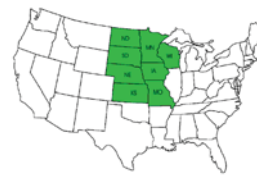

ACTUAL FREIGHT CHARGES APPLY TO FORTRESS™ RAIL ORDERS



Available in:

- Black Sand
- Ant. Bronze
- White

Fortress® Round Handrail End Cap

2/Pack

Finishes end of handrail, use 2 part epoxy for installation.

- Item # 50500038 - Black Sand (Textured)
- Item # 50500036 - Antique Bronze
- Item # 50500031 - White



Available in:

- Black Sand
- Ant. Bronze
- White

Fortress® Touch Up Paint

Sold in any quantity.

Available in two convenient sizes.

Spray Can (6oz)

- Item # 660378 - Black Sand
- Item # 660376 - Antique Bronze
- Item # 660371 - White

Paint Pen

- Item # 660368 - Black Sand
- Item # 660366 - Antique Bronze
- Item # 660361 - White

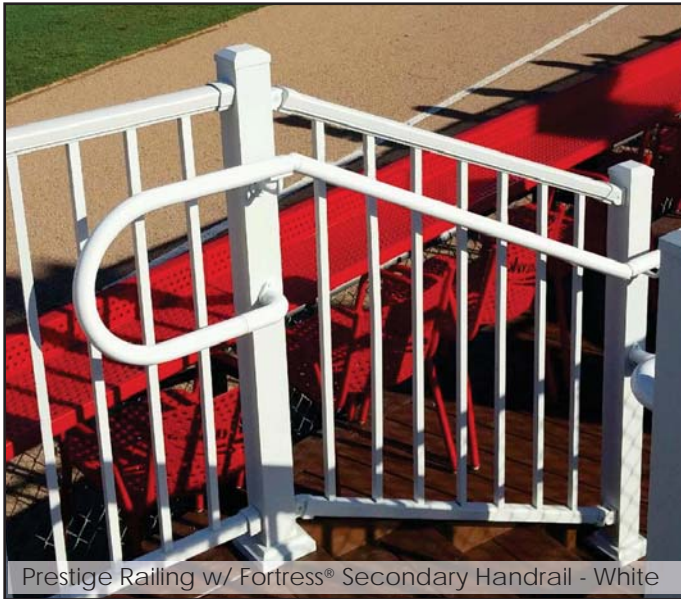

Prestige Railing w/ Fortress® Secondary Handrail - White



Fortress® Iron Railing w/ Cap Rail - Black Sand

ADITM

CABLE RAILING FOR WOOD



DekPro InvisiCable™
Cable Rail for Wood

pg 108 - 109

NEW

RailFX® Express Mount Brackets
Cable Rail for Wood

pg 110 - 113

ADI™ Cable Railing System
by RailFX®

pg 114 - 126

DekPro InvisiCable™



Cable Railing for Wood Systems

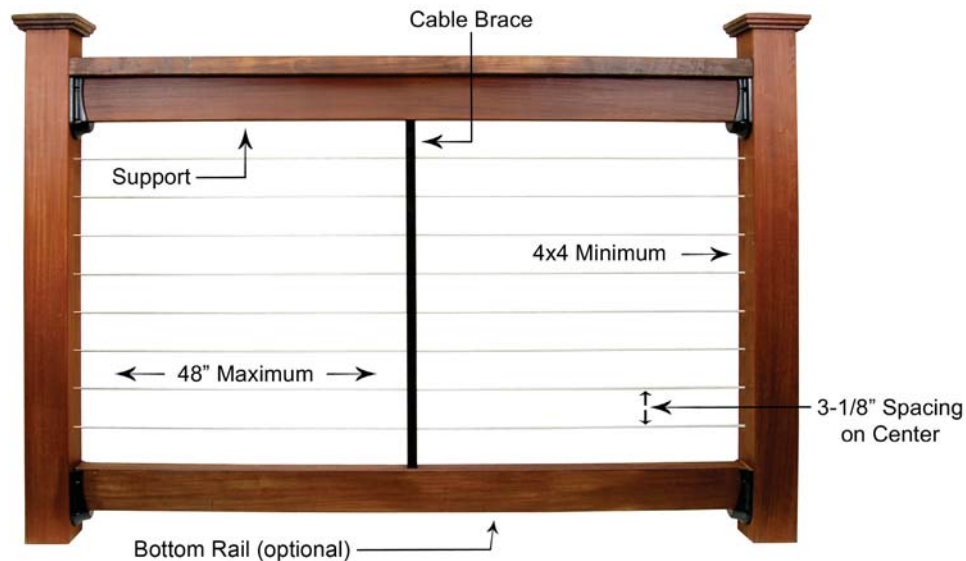

A simple, affordable cable railing option for the value conscious consumer that wants the look of cable but at a lower cost. Made from 316 marine-grade stainless steel components and cable.

Kit includes 1 run of cable with 2.75" broached threaded tensioner, Pull-Lock fitting, two end caps, washers and brass Nylock hex nut. Kits are field trimmable to the proper length and come in 5' increments to 30' then 40' and 50'.

Don't confuse this kit with a competitors – we include **BOTH** end caps in each kit!

Perfect for interior and exterior use – decks, docks, balconies and stairways utilizing wood or solid composite posts. Fittings are concealed in the post creating a clean, almost invisible infill. Holes are drilled straight through the post and no angled holes or beveled washers are required.

Backed by ADI™ and DekPro™ Manufacturing with a 10 Year Warranty

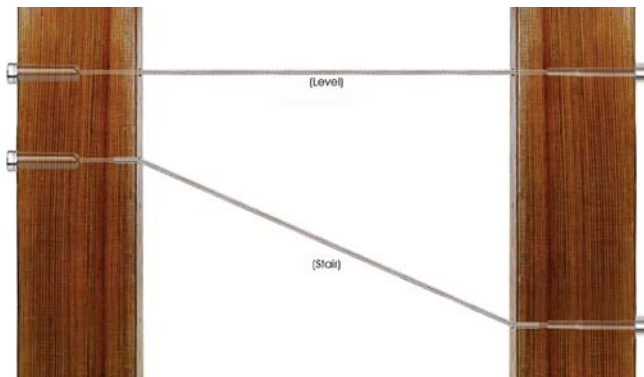

For level runs:

- Threaded Tensioner to Pull-Lock®.

For stairs, pitched runs:

- Threaded Tensioner to Pull-Lock® with 3/4" Post Protector Sleeve



Wood Rail w/ InvisiCableTM

DekProTM InvisiCable for Wood



InvisiCableTM Kit for Wood

Sold in kits.

Cable railing kit made from 1/8" high quality 316 grade stainless steel. Includes 1 strand of cable with 2.75" threaded stud on one end, Pull-LockTM fitting, washers, nut and 2 end caps.

- Item #: IC05 - 5' Cable Kit
- Item #: IC10 - 10' Cable Kit
- Item #: IC15 - 15' Cable Kit
- Item #: IC20 - 20' Cable Kit
- Item #: IC25 - 25' Cable Kit
- Item #: IC30 - 30' Cable Kit
- Item #: IC40 - 40' Cable Kit
- Item #: IC50 - 50' Cable Kit
- Item #: IC60 - 60' Cable Kit
- Item #: IC70 - 70' Cable Kit



THREADED STUD WITH
CAP, NUT AND WASHER



PULL-LOCKTM LAG

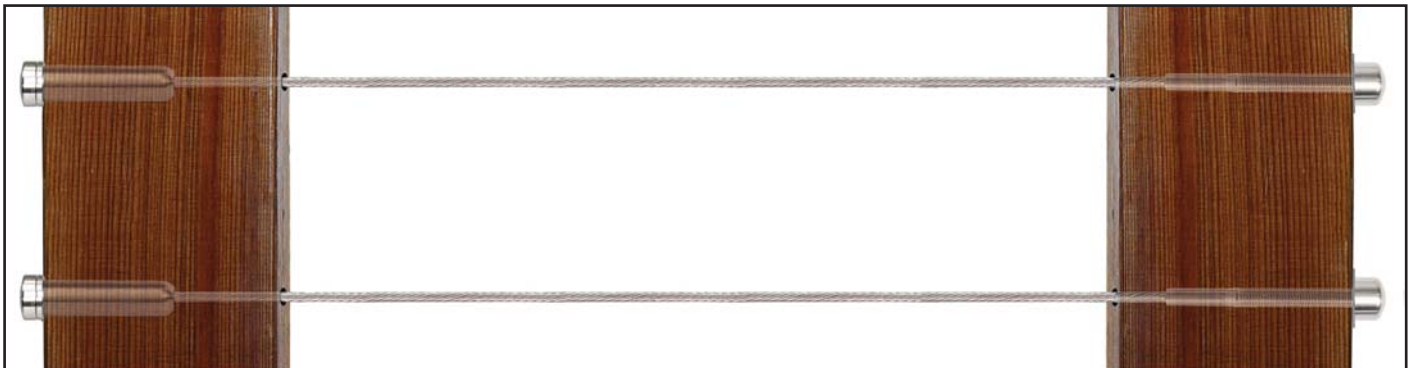

Express Mount Brackets for Cable



Express Mount Brackets™

Cable Railing Made Easy!



End Bracket

End Posts - Level & Stair



Intermediate Bracket

Intermediate Posts - Level & Stair



Corner Bracket

Corners Posts & 45° Angles

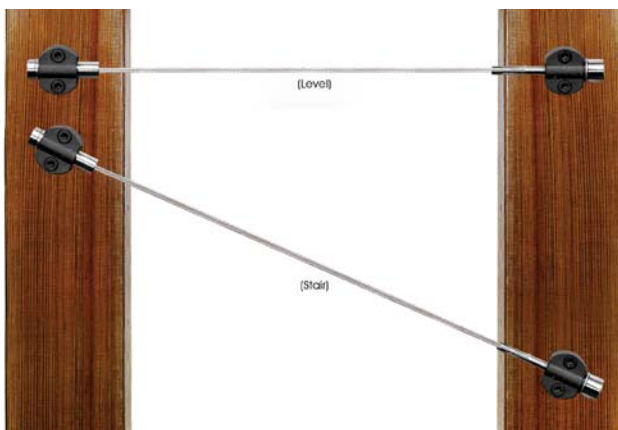

For level runs:

- Threaded Tensioner to Pull-Lock®.

For stairs, pitched runs:

- Threaded Tensioner to Pull-Lock®.



RailFX[®] Express Mount Brackets w/ DekPro[™] InvisiCable

DekPro[™] InvisiCable for Express Mount Brackets



InvisiCable[™] Kit for Wood

Sold in kits.

Cable railing kit made from 1/8" high quality 316 grade stainless steel. Includes 1 strand of cable with 2.75" threaded stud on one end, Pull-Lock[™] fitting, washers, nut and 2 end caps.

- Item #: IC05 - 5' Cable Kit
- Item #: IC10 - 10' Cable Kit
- Item #: IC15 - 15' Cable Kit
- Item #: IC20 - 20' Cable Kit
- Item #: IC25 - 25' Cable Kit
- Item #: IC30 - 30' Cable Kit
- Item #: IC40 - 40' Cable Kit
- Item #: IC50 - 50' Cable Kit
- Item #: IC60 - 60' Cable Kit
- Item #: IC70 - 70' Cable Kit



THREADED STUD WITH
CAP, NUT AND WASHER



PULL-LOCK[™] LAG

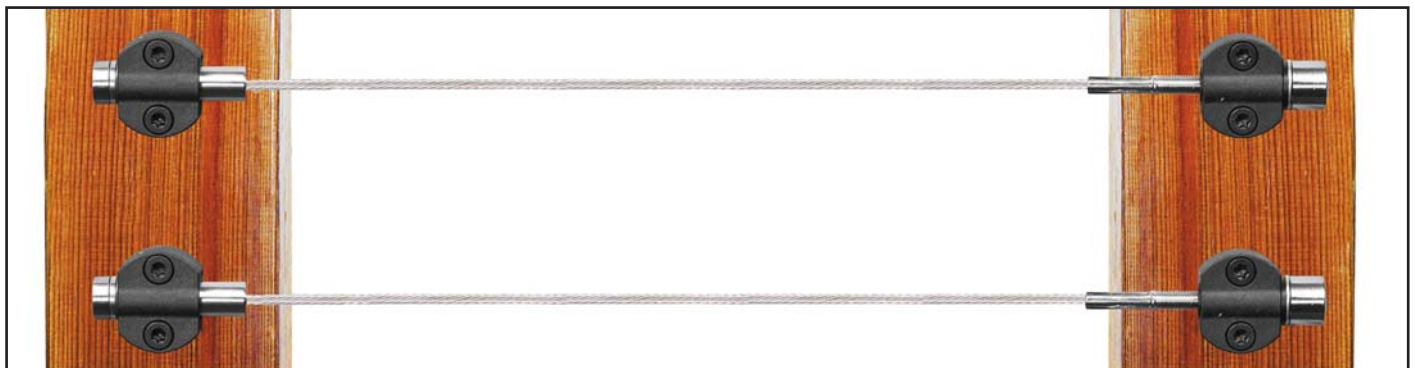



Available in:
Black

Express Mount - End Fitting

Sold in 20 Packs.

End fittings attaches to end post and holds cable fitting. Kit includes: 20 End Fittings, 20 Fitting Adapters & 40 Wood Screws with T25 Torx Drive.

Item # RFXFMCEFKIT



Available in:
Black

Express Mount - Intermediate Fitting

Sold in 10 Packs.

Intermediate fittings attaches to intermediate post and allows cable to pass through. Kit includes: 10 Intermediate Fittings & 20 Wood Screws with T25 Torx Drive.

Item # RFXFMCIFKIT



Available in:
Black

Express Mount - Corner Fitting

Sold in 10 Packs.

Corner fittings attach to corner post and allows cable to pass around the corner post smoothly. Kit includes: 10 Corner Fittings & 20 Wood Screws with T25 Torx Drive.

Item # RFXFMCCFKIT

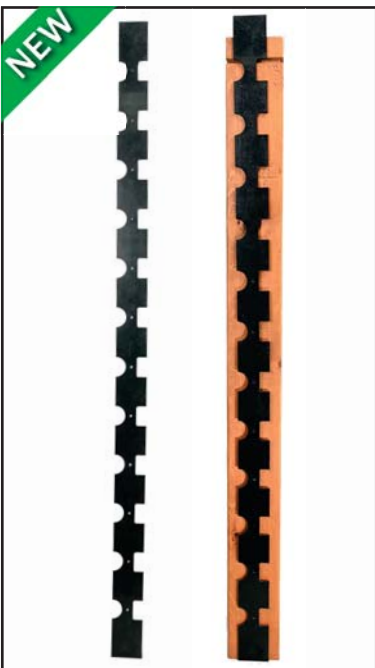

Available in:
Black

Express Mount Post Template

Sold in any quantity.

Post Template correctly spaces out cable fittings. Works for End, Intermediate and Corner fittings. Must be clamped to post.

Item # RFXFMCFITEMP



RailFX® Express Mount Brackets w/ DekPro™ InvisiCable



RailFX® Express Mount Brackets w/ DekPro™ InvisiCable



RailFX® Express Mount Brackets w/ DekPro™ InvisiCable

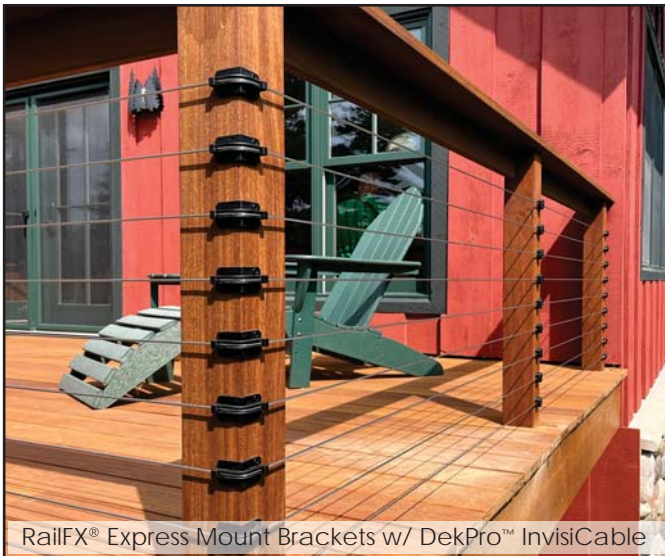

RailFX® Express Mount Brackets w/ DekPro™ InvisiCable



RailFX® Express Mount Brackets w/ DekPro™ InvisiCable

Cable Railing Overview

Framework for Cable Railing

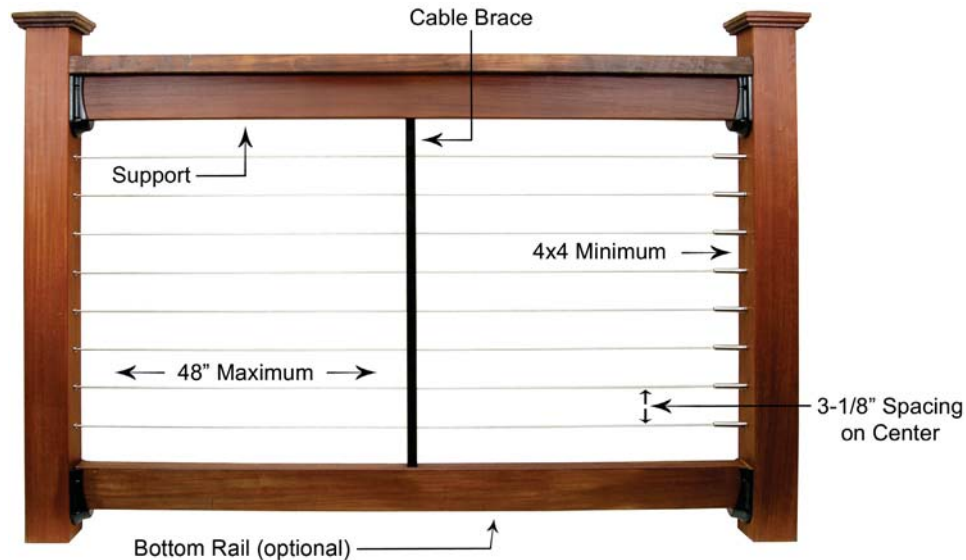

Guidelines for proper installation of the ADI™ cable railing system by RailFX®

- Use minimum 4x4 wood posts.
- Top rail is **required** to support posts. (Bottom rail is optional)
- Cables to be spaced at 3-1/8" on center.
- Cable must be supported every 48" to keep the cable from deflecting over 4" to pass code.
- Cables are to be tensioned to **225 lbs** of tension minimum.
- 36" Rail height typically uses 10 runs of cable, 42" rail height typically uses 12 runs of cable.
- Lag style cable fittings are required for cable being used with sleeved posts.
- If two posts are used on a corner of the deck, the cable can run through the corner by making a 45 degree turn through the posts with the use of post protector tubes.

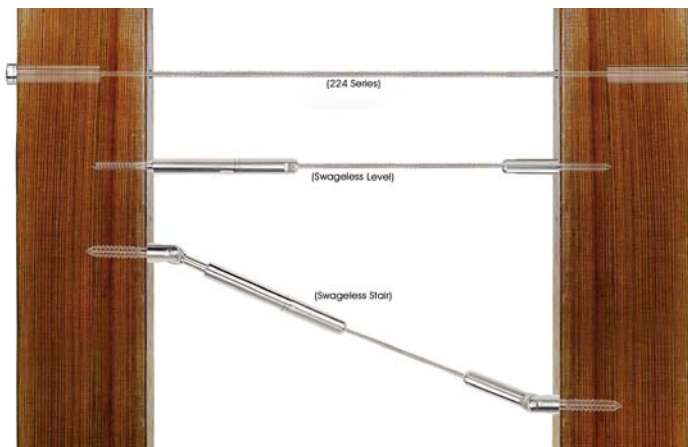

For level runs:

224 Series (outside to outside)
2-3/8" Invisiware® Receiver
to Pull-Lock®.

FlexFX - Level Cable Fittings
Lag style, Swageless Push-lock fittings.
Level Tensioner & Non-Tensioner

For stairs, pitched runs:

FlexFX - Stair Cable Fittings
Lag style, Swageless Push-lock fittings.
Stair Tensioner & Non-Tensioner



Wood Rail w/ Cable

Cable Railing Kits for Wood - Level



224 SERIES



INVISIWARE[®] RECEIVER



PULL-LOCK[™] END FITTING



Recommended Drill Bit

Outside of Post to Outside of Post Rail Kit - Wood Post

Sold in kits.

Cable railing kit made from 1/8" high quality 316 grade stainless steel. Includes 1 strand of cable with one swaged end, applicable washers, Invisiware[®] receiver, Pull-Lock[™] end fitting and end cap. Minimum of 3" clearance between end post and structure is required.

Individual Cable Kits

- Item #: 22405 - 5' Cable Kit
- Item #: 22410 - 10' Cable Kit
- Item #: 22415 - 15' Cable Kit
- Item #: 22420 - 20' Cable Kit
- Item #: 22425 - 25' Cable Kit
- Item #: 22430 - 30' Cable Kit
- Item #: 22440 - 40' Cable Kit
- Item #: 22450 - 50' Cable Kit
- Item #: 22460 - 60' Cable Kit
- Item #: 22470 - 70' Cable Kit



10 Pack Cable Contractor Packs

Cable contractor packs include 10 - cables with one swaged end, 10 - Invisiware[®] receivers, 10 - Pull-Lock[™] end fittings w/ end caps and applicable washers.

- Item #: 22405-10 - 5' Cable Kits
- Item #: 22410-10 - 10' Cable Kits
- Item #: 22415-10 - 15' Cable Kits
- Item #: 22420-10 - 20' Cable Kits
- Item #: 22425-10 - 25' Cable Kits
- Item #: 22430-10 - 30' Cable Kits



- Item #: CSD316 - Step Drill Bit to make 29/64" hole for fitting and 3/16" hole for cable.

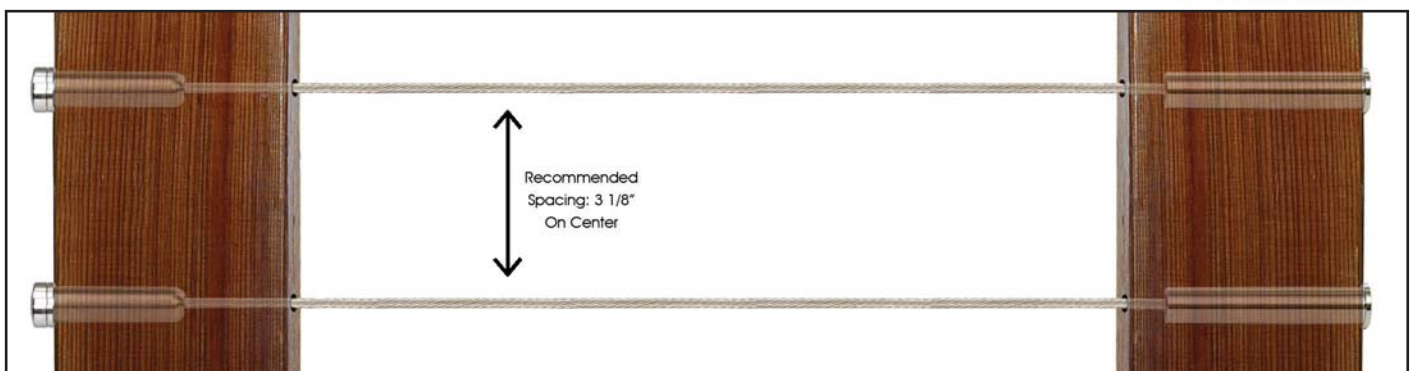

Recommended Spacing: 3 1/8" On Center



Wood Rail w/ FlexFXTM Cable

FlexFXTM Cable Railing for Wood - Level



FOR WOOD

FlexFXTM - Cable Fittings for Wood

Sold in any quantity.

Cable railing and fittings made from high quality 316 grade stainless steel. Designed to work for wood posts. Pre-drill wood post using 7/32" drill bit.

Level Non-Tensioner Fittings

- Item #: RFXWLN1/8 - 1/8" Fitting
- Item #: RFXWLN1/8-10 - 1/8" Fitting (10 Pack)
- Item #: RFXWLN3/16 - 3/16" Fitting

NON-TENSIONER



Level Tensioner Fittings

- Item #: RFXWLT1/8 - 1/8" Fitting
- Item #: RFXWLT1/8-10 - 1/8" Fitting (10 Pack)
- Item #: RFXWLT3/16 - 3/16" Fitting

TENSIONER



Bulk Cable

- Item #: RFXCABLE100 - 100' Spool of 1/8" Cable
- Item #: RFXCABLE500 - 500' Spool of 1/8" Cable



- Item #: RFXCABLE100-6 - 100' Spool of 3/16" Cable
- Item #: RFXCABLE500-6 - 500' Spool of 3/16" Cable

Fitting Dimensions available for reference on page 126

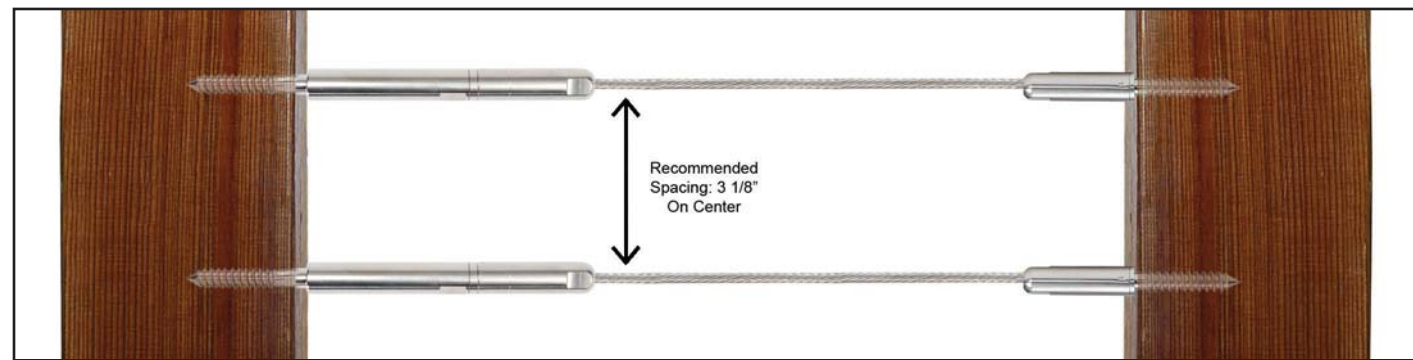



Wood Rail w/ FlexFXTM Cable

FlexFXTM Cable Railing for Wood - Stair



FOR WOOD

FlexFXTM - Cable Fittings for Wood

Sold in any quantity.

Cable railing and fittings made from high quality 316 grade stainless steel. Designed to work for wood posts. Pre-drill wood post using 7/32" drill bit.

Stair Non-Tensioner Fittings

- Item #: RFXWSN1/8 - 1/8" Fitting
- Item #: RFXWSN1/8-10 - 1/8" Fitting (10 Pack)
- Item #: RFXWSN3/16 - 3/16" Fitting

NON-TENSIONER



Stair Tensioner Fittings

- Item #: RFXWST1/8 - 1/8" Fitting
- Item #: RFXWST1/8-10 - 1/8" Fitting (10 Pack)
- Item #: RFXWST3/16 - 3/16" Fitting

TENSIONER



Bulk Cable

- Item #: RFXCABLE100 - 100' Spool of 1/8" Cable
- Item #: RFXCABLE500 - 500' Spool of 1/8" Cable

- Item #: RFXCABLE100-6 - 100' Spool of 3/16" Cable
- Item #: RFXCABLE500-6 - 500' Spool of 3/16" Cable



Fitting Dimensions available for reference on page 126

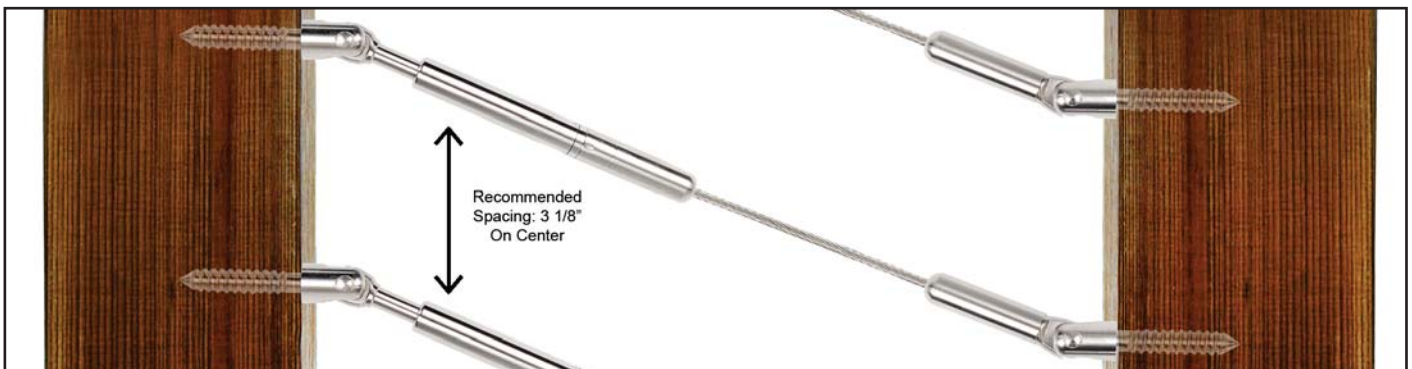



Composite Sleeved Rail w/ FlexFXTM Cable

FlexFXTM Cable Railing for Composite Sleeve - Level

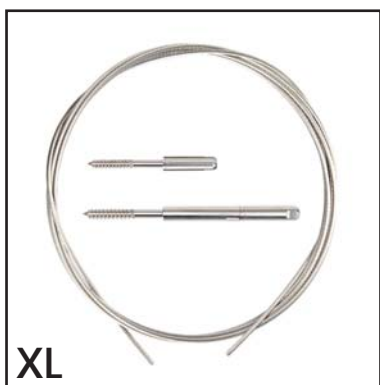

XL

**FOR
COMPOSITE
SLEEVES**

(1" Longer Lag)

*Fitting Dimensions available
for reference on page 126*

FlexFXTM XL - Cable Fittings for Composite Sleeves

Sold in any quantity.

Cable railing and fittings made from high quality 316 grade stainless steel. Designed to work for composite sleeved wood posts. Pre-drill using 7/32" drill bit.

XL - Level Non-Tensioner Fittings

- Item #: RFXWLN1/8XL - 1/8" Fitting
- Item #: RFXWLN1/8XL-10 - 1/8" Fitting (10 Pack)
- Item #: RFXWLN3/16XL - 3/16" Fitting

XL - NON-TENSIONER



XL - Level Tensioner Fittings

- Item #: RFXWLT1/8XL - 1/8" Fitting
- Item #: RFXWLT1/8XL-10 - 1/8" Fitting (10 Pack)
- Item #: RFXWLT3/16XL - 3/16" Fitting

XL - TENSIONER



Bulk Cable

- Item #: RFXCABLE100 - 100' Spool of 1/8" Cable
- Item #: RFXCABLE500 - 500' Spool of 1/8" Cable

- Item #: RFXCABLE100-6 - 100' Spool of 3/16" Cable
- Item #: RFXCABLE500-6 - 500' Spool of 3/16" Cable

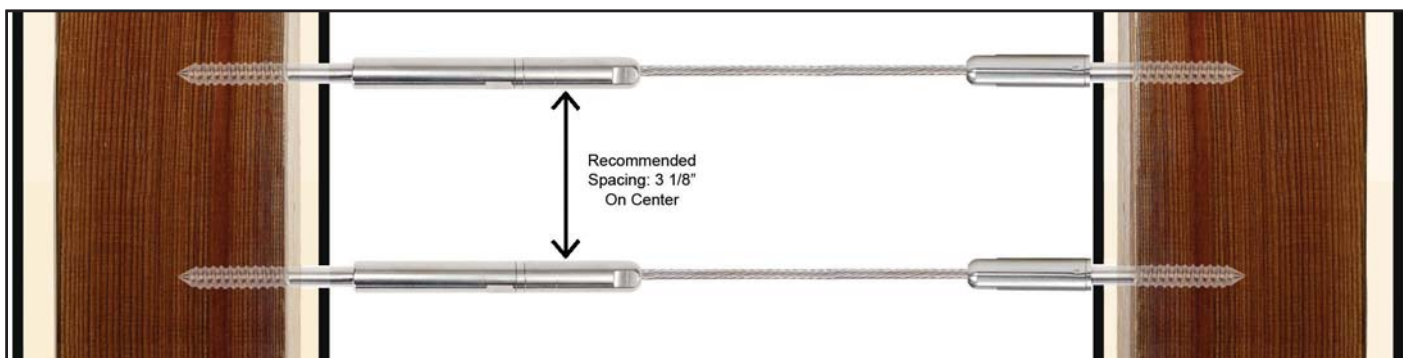

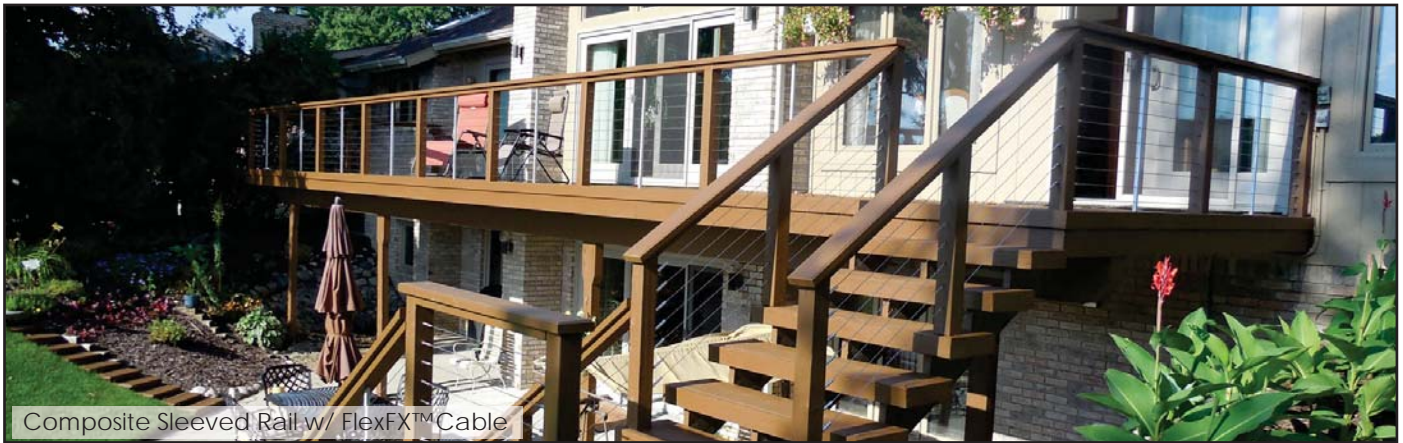

Composite Sleeved Rail w/ FlexFXTM Cable

FlexFXTM Cable Railing for Composite Sleeve - Stair

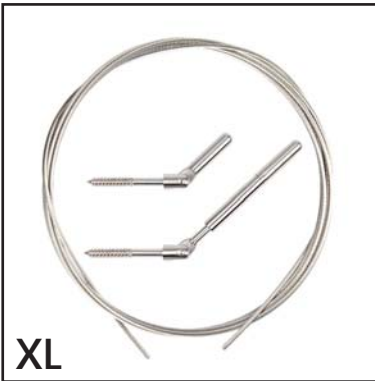

XL

**FOR
COMPOSITE
SLEEVES**
(1" Longer Lag)

FlexFXTM XL - Cable Fittings for Composite Sleeves

Sold in any quantity.

Cable railing and fittings made from high quality 316 grade stainless steel. Designed to work for composite sleeved wood posts. Pre-drill using 7/32" drill bit.

XL - Stair Non-Tensioner Fittings

- Item #: RFXWSN1/8XL - 1/8" Fitting
- Item #: RFXWSN1/8XL-10 - 1/8" Fitting (10 Pack)
- Item #: RFXWSN3/16 - 3/16" Fitting



XL - NON-TENSIONER

XL - Stair Tensioner Fittings

- Item #: RFXWST1/8XL - 1/8" Fitting
- Item #: RFXWST1/8XL-10 - 1/8" Fitting (10 Pack)
- Item #: RFXWST3/16XL - 3/16" Fitting



XL - TENSIONER

Bulk Cable

- Item #: RFXCABLE100 - 100' Spool of 1/8" Cable
- Item #: RFXCABLE500 - 500' Spool of 1/8" Cable

- Item #: RFXCABLE100-6 - 100' Spool of 3/16" Cable
- Item #: RFXCABLE500-6 - 500' Spool of 3/16" Cable



Fitting Dimensions available for reference on page 126

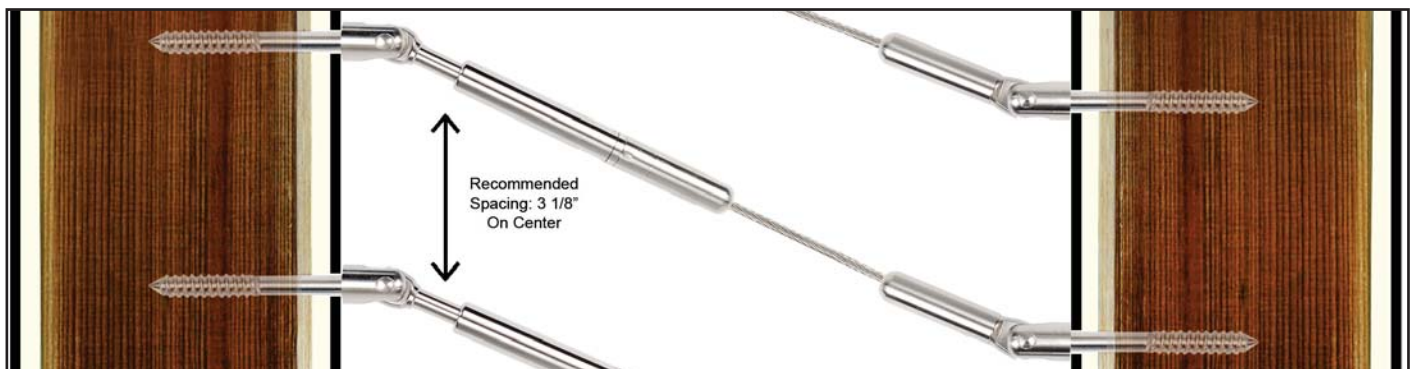

Recommended Spacing: 3 1/8" On Center

Cable Braces

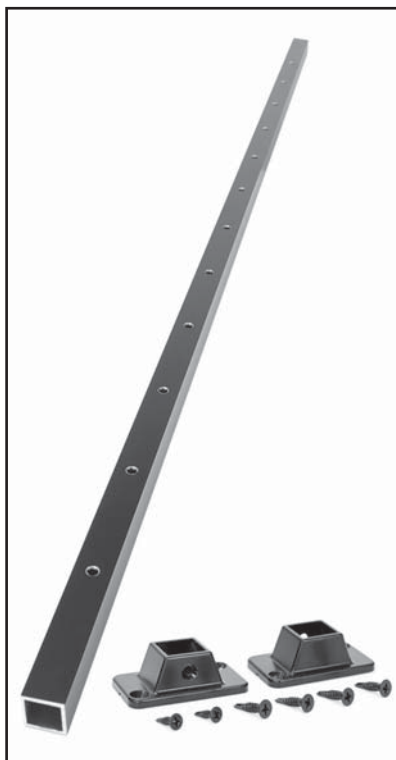

Available in:

Black

Silver

Cable Brace for Level (1/8" Cable Only)

Sold in any quantity.

5/8" X 42" Aluminum cable brace is available pre-drilled with 12 holes at 3-1/8" spacing on center for level runs. New design allows for cable braces to be installed after railing framework is in place. Trimmable to fit any rail height. Cable braces are used between newel posts that are greater than 48" apart to keep cables from deflecting over 4". Connector shoes and screws included.

Pre-Drilled 42" Level

Item # RFXCB42BL12/P - Black (shown)
Item # RFXCB42SI12/P - Silver



Pictures do not reflect full length of cable brace



Available in:

Black

Silver

Cable Brace for Stair (1/8" Cable Only)

Sold in any quantity.

5/8" x 50" Aluminum cable brace is available pre-drilled with 12 holes at 3-1/8" spacing on center for stair runs. Holes are slotted and offset to allow for use with stairs angles between 30 - 40 degrees. New design allows for cable braces to be installed after railing framework is in place. Bottom shoe can be angled or straight. Trimmable to fit any rail height. Cable braces are used between newel posts that are greater than 48" apart to keep cables from deflecting over 4". Connector shoes and screws included.

Pre-Drilled 50" Stair

Item # RFXCB50BL12S/P - Black (shown)
Item # RFXCB50SI12S/P - Silver



Pictures do not reflect full length of cable brace

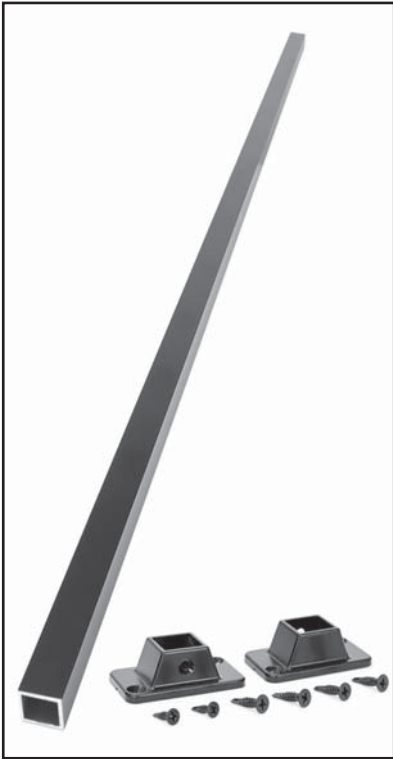

Available in:

Black

Silver

Cable Brace Undrilled

Sold in any quantity.

5/8" x 50" Aluminum cable brace is undrilled to allow for custom hole drilling. New design allows for cable braces to be installed after railing framework is in place. Trimmable to fit any rail height. Cable braces are used between newel posts that are greater than 48" apart to keep cables from deflecting over 4". Connector shoes and screws included.

Undrilled 50"

Item # **RFXCBU50BL/P** - Black (shown)

Item # **RFXCBU50SIP** - Silver

Pictures do not reflect full length of cable brace



FlexFX Cables w/ Painted Wood Rail

Cable Railing Tools



Post Protector Tubes

Sold in packs of 10.

Stainless Steel protector tubes are inserted into wood post where cable enters/exits at an angle to prevent cable from biting into the wood. 1/4" diameter with 3/8" tapered end.

Item #: ICTUBE/10 - 3/4" Length - 10 pack
Item #: CSTUBE6 - 1-1/2" Length - Individual

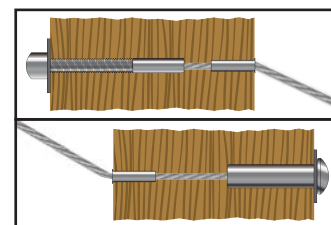

Cable Cutters

Sold in any quantity.

Cable cutter designed for clean, burr free cutting of 1/8" stainless steel cable. Required for use with FlexFXTM lag style fittings.

Item #: RFXC7HIT - for 1/8" Cable
Item #: RFXC9 - for 3/16" Cable



Push Lock Release Key (1/8" Cable Only)

Sold in any quantity.

Release key allows the release of an untensioned cable from Pull-LockTM and FlexFXTM fittings. Also used to release fittings to aid installation.

Item #: RFXPLKEY/R



Cable Gripping Pliers

Sold in any quantity.

Used to securely grip cable to avoid winding during installation which eliminates the most common issue of cables losing tension. Cable gripping pliers are recommended for professional installers.

Item #: RFXPLIERS





Cable Cut Off Kit

Sold in any quantity.

Used to cut cable flush to the end of Pull-LockTM fittings and excess threads from stud type tensioners. Includes mandrel and 2 cut off wheels.

Item #: RFXCUTOFFKIT/R



Push-Lock Lag Driver

Sold in any quantity.

Huge time saving tool makes installing the FlexFXTM non-tensioning lag fitting quick and easy. Used with WLN series FlexFX cable fittings.

Item #: RFXDRIVER/R



FlexFXTM Cable Railing Install Kit

Sold as a Kit.

Installation tools for FlexFXTM Swageless lag style cable railing. Kit includes 7/32", 1/4" and 5/32" diameter drill bits, 2 push lock release keys, cable gripping tool, Push-Lock lag driver, 5/32" allen wrench, and 2 - 3" combo wrenches.

Item #: RFXINSKIT

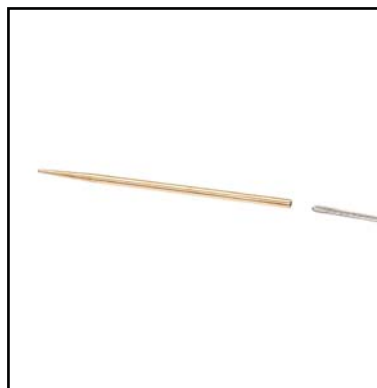

Cable Lacing Needle (1/8" Cable Only)

Sold in any quantity.

Used to pass 1/8" cable through posts without snagging / fraying during installation. Fits 3/16" diameter hole or larger.

Item # RFXNEEDLE - Cable Lacing Needle





QuickGrip Cable Tool

Sold in Packs of 2.

Used to grip cable to avoid winding during installation which eliminates the most common issue of cables losing tension. Tool is recommended for single installations.

Item #: RFXGRIPPER



EZ-Clean Metal Cleaner / Protectant

Sold in any quantity.

Cleaner / Protector dissolves minor corrosion and leaves a protective coating that lasts for months. Includes 8 oz. rust and stain remover and 4 oz. bottle of protectant.

Item #: RFXEPCLEAN



Cable Pre-Tensioner Tool

Sold in any quantity.

Cable pre-tensioner tool is typically needed when using long runs of cable (Over 50') with multiple turns. This tool pulls the cables to tension to easily allow the installer to feed the cable into the non-tensioning cable fitting. Hand ratchet is used to rotate threaded rod to pull tension on the cable. **Do not** use power tools.

Item # FXPRETENSIONER01



Cable lays into tool



Tool sets against the post



Rotate using ratchet to pull tension



Cable Railing Drill Bits

Sold in any quantity.

For wood, to make 29/64" hole for Invisiware receiver / Pull-Lock fittings. Step drill bit creates a 3/16" hole for the cable using a single drill bit.

Item #: CSD316 - ADI Step Drill Bit (29/64" to 3/16")

Item #: 29/64DRILL - 29/64" Drill Bit

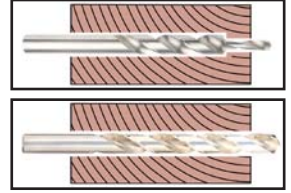

FlexFXTM-XL Cables w/ Composite Sleeved Rail



FlexFXTM Cables w/ Wood Rail



DekProTM InvisiCable w/ Painted Wood Railing

FlexFX[™] Cable Fitting Reference Guide

FlexFX[™] - Cable Fittings for Wood

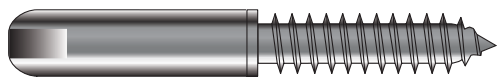

Level - Non-Tensioner for Wood (RFXWLN1/8)

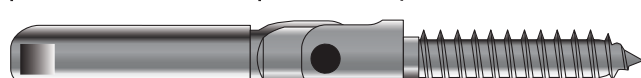
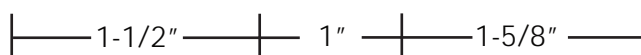

Stair - Non-Tensioner for Wood (RFXWSN1/8)

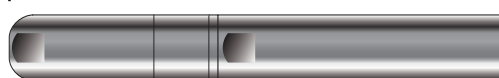

Level - Tensioner for Wood (RFXWLT1/8)

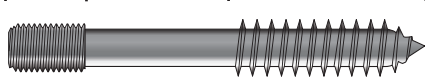

Stair - Tensioner for Wood (RFXWST1/8)

FlexFX[™] - XL Cable Fittings for Composite Sleeves

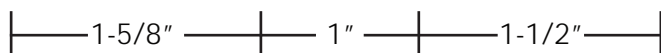

Level - Non-Tensioner for Composite (RFXWLN1/8XL)

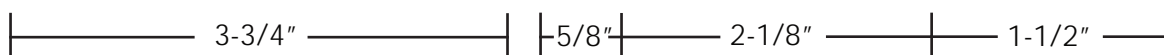

Level - Tensioner for Composite (RFXWLT1/8XL)

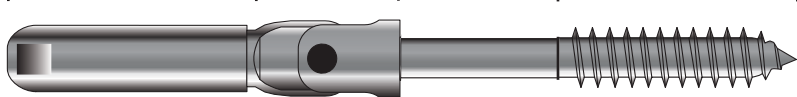

Stair - Non-Tensioner for Composite (RFXWSN1/8XL)

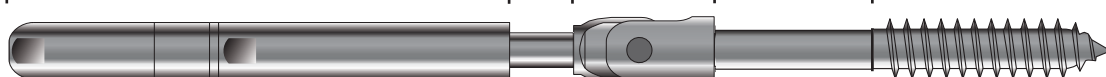

Stair - Tensioner for Composite (RFXWST1/8XL)

CABLE RAILING FOR METAL

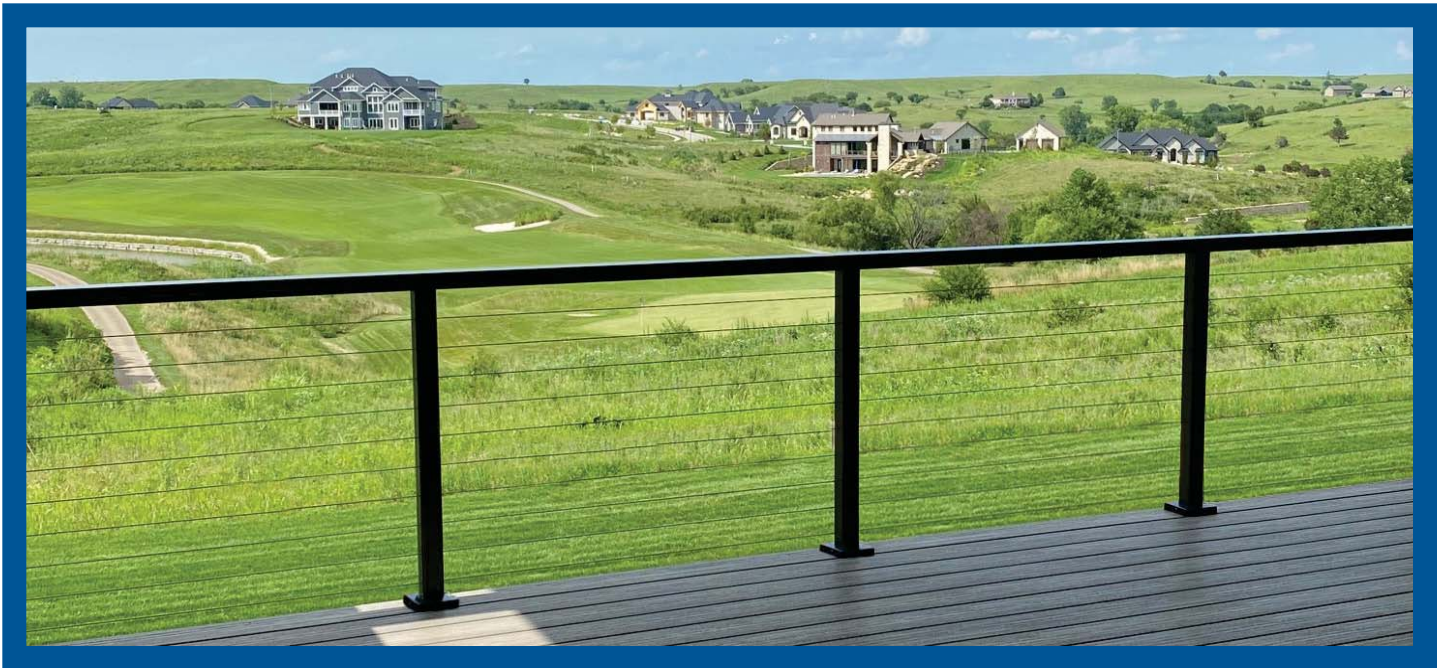

RailFX® Custom - Over-the-Post (OTP)

Aluminum Railing
and Cable System

pg 128 - 151

NEW

RailFX® Oasis - Post-to-Post (PTP)

Aluminum Railing
and Cable System

pg 152 - 163

Fortress®

Aluminum Vertical Cable Railing

pg 164 - 169

DekPro™ Prestige

Textured Aluminum Rail for Cable

pg 170 - 173

RailFX® FlexFX for Metal

Cable for Metal Posts

pg 174 - 177

RailFX® Custom System Overview

RailFX® Custom Aluminum Rail with Cable

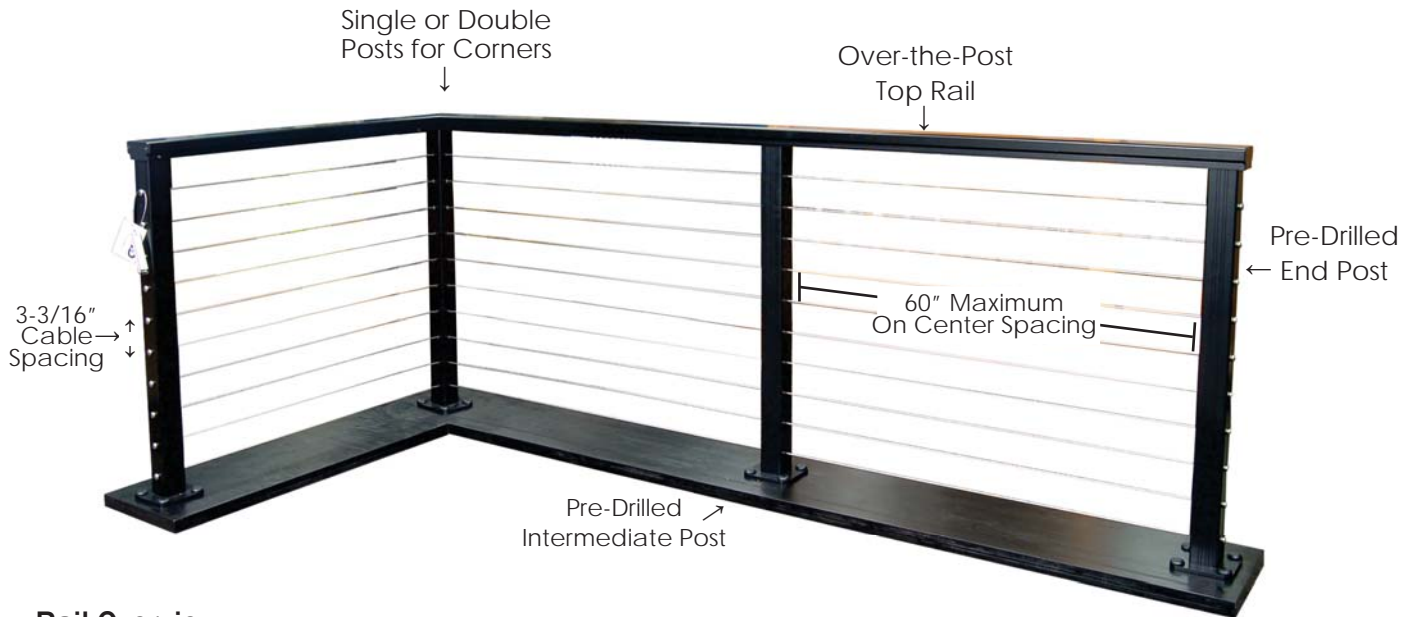

Rail Overview

Manufactured using aircraft grade aluminum, RailFX® Aluminum Rail and Cable System has been designed, engineered and tested specifically for use with cable and is approved in all 50 states. The aluminum framework and stainless steel cable allows for railings to be lightweight, while still retaining exceptional durability. Railings will not rust, rot, warp, or split and require minimal user maintenance.

Rail Guidelines

To comply with engineering and testing **posts must be spaced no more than 60" on center**. Cables are spaced at 3-3/16" on center to keep the cable from deflecting beyond 4" to meet code. Single or double posts can be used to create a 90 degree corner for surface mount or fascia mount w/ bracket applications. Two corner posts are required for Direct Mount fascia applications. Cable can either terminate at the corner or run continuously through a single corner. Top rail is required for all installations.

Posts - Surface or Fascia Mount

RailFX® posts for level and stair railings are all predrilled and ready for cable installation. Stairs posts do not come with base plates attached so posts can be placed and mounted where desired for maximizing installation flexibility. All posts are available for surface mount or fascia mount and available for 36" and/or 42" rail heights.

Top Rails

There are 3 styles of top rail that RailFX® railing utilizes:

Series 200 is a contemporary flat top rail most often used for level applications. Can be used for stairs with the addition of a secondary handrail system.

Series 250 is a square profile that qualifies as a graspable rail and is most commonly used for stairs.

Series 400 is a flat top rail that is designed to accept a wood or composite cap rail.

Available Colors:

Colors shown are approximate representation



Black



Bronze



White



Silver

Features AAMA 2604 Powder Coat Finish

RailFX[®] - Aluminum Rail System for Cable Railing



RailFX[®] Aluminum Rail and Cable - Bronze - Series 200 Top Rail

Cable Railing Kits for Aluminum Rail



224 SERIES

Outside of Post to Outside of Post Rail Kit - Aluminum Rail System for 2-3/8" Posts

Sold in kits.

Cable railing kit, made from 1/8" high quality 316 grade stainless steel. Includes 1 strand of cable with one swaged end, applicable washers, Invisiware[®] receiver, Pull-Lock[™] end fitting and end cap. Minimum 3" clearance between end post and structure is required.

Individual Cable Kits

- Item #: 22405 - 5' Cable Kit
- Item #: 22410 - 10' Cable Kit
- Item #: 22415 - 15' Cable Kit
- Item #: 22420 - 20' Cable Kit
- Item #: 22425 - 25' Cable Kit
- Item #: 22430 - 30' Cable Kit
- Item #: 22440 - 40' Cable Kit
- Item #: 22450 - 50' Cable Kit
- Item #: 22460 - 60' Cable Kit
- Item #: 22470 - 70' Cable Kit



INVISIWARE[®] RECEIVER



PULL-LOCK[™] END FITTING

10 Pack Cable Contractor Packs

- Item #: 22405-10 - 5' Cable Kits
- Item #: 22410-10 - 10' Cable Kits
- Item #: 22415-10 - 15' Cable Kits
- Item #: 22420-10 - 20' Cable Kits
- Item #: 22425-10 - 25' Cable Kits
- Item #: 22430-10 - 30' Cable Kits

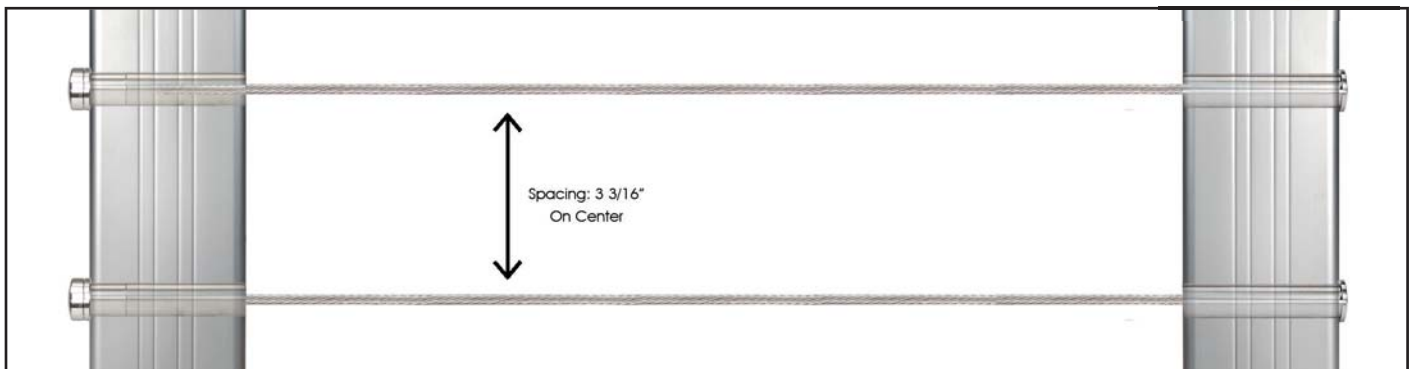

ACTUAL FREIGHT CHARGES WILL BE APPLIED TO RAILFX® ORDERS



RailFX® Aluminum Rail and Cable - Black - Series 200 Top Rail

RailFX® Series 200 Top Rail



Available in:

Black

Bronze

White

Silver

Series 200 Top Rail

Sold in any quantity.

3-1/2" x 1-7/8" x 94" Series 200 aluminum top rail. Join multiple rails together with splices to achieve any length required. Field trimmable with carbide blade. Includes bottom finishing plate for clean look.

End plate sold separately.

94" Top Rail (3-1/2" x 1-7/8" x 94")

Item #: FXTR200BLKKIT8 - Black

Item #: FXTR200BRZKIT8 - Bronze

Item #: FXTR200WHTKIT8 - White

Item #: FXTR200SILKIT8 - Silver

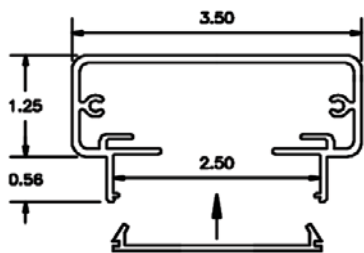

Available in:

Black

Bronze

White

Silver

Series 200 Top Rail End Plate

Sold in any quantity.

Aluminum end plate required to cap series 200 top rail ends for a finished look. Includes 2 color matched screws.

Item #: FXEP200BLK - Black

Item #: FXEP200BRZ - Bronze

Item #: FXEP200WHT - White

Item #: FXEP200SIL - Silver



ACTUAL FREIGHT CHARGES WILL BE APPLIED TO RAILFX® ORDERS

RailFX® Series 200 Rail Splices



Available in:
Aluminum

Straight Splice - 200 Series

Sold in any quantity.

9" long splice joins straight sections of series 200 top rail to make any length run. Splices can be used between posts or directly on top of posts. Installs using 8 - #10 x 3/4" self-drilling screws (Not Included)

Item #: FXSPL200 - Straight Splice



Available in:
Aluminum

Universal Splice - 200 Series

Sold in any quantity.

Universal Level Splice for 200 Series top rail adjusts to accommodate for any angle from 0° - 90°. Requires miter cutting of top rail. Installs using 8 - #10 x 3/4" self-drilling screws (Not Included)

Item #: FXSPL200UNIVERSL - Universal Splice 200

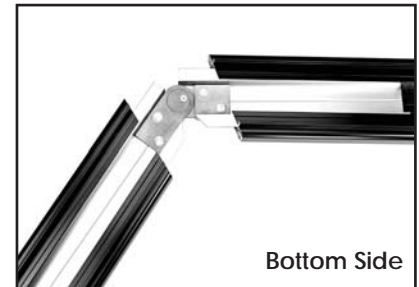
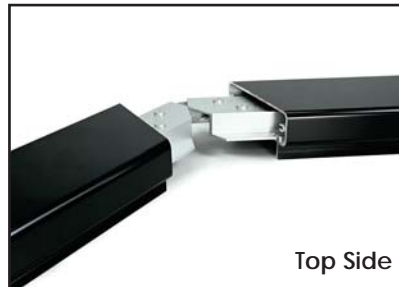

Available in:
Aluminum

Notched Splice for Stairs - 200 Series

Sold in any quantity.

For continuous level to stair transition. Bends to accommodate any angle from 0° - 38°. Requires miter cutting of top rail. Installs using 8 - #10 x 3/4" self-drilling screws (Not Included)

Item #: FXSPLST - Notched Splice



ACTUAL FREIGHT CHARGES WILL BE APPLIED TO RAILFX® ORDERS

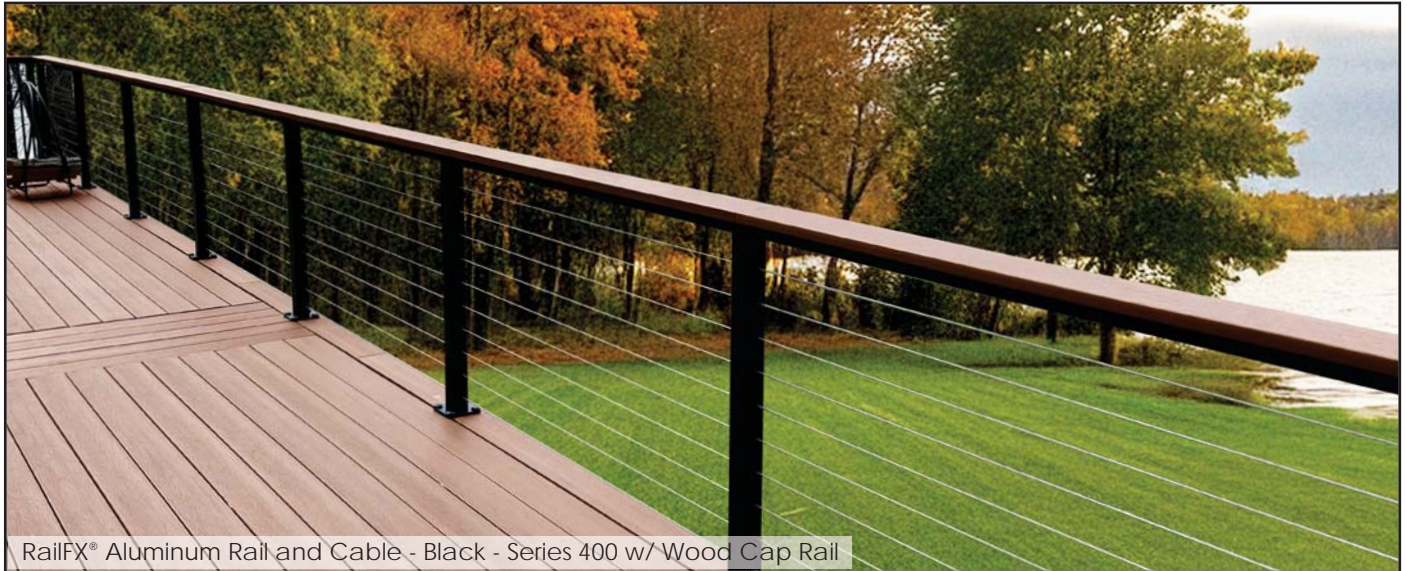

RailFX® Aluminum Rail and Cable - Black - Series 400 w/ Wood Cap Rail

RailFX® Series 400 Top Rail



Available in:

Black

Bronze

White

Silver

Series 400 Top Rail for Wood Cap Rail

Sold in any quantity.

2-7/8" x 1-1/4" x 94" Series 400 aluminum rail cap for attaching wood/composite top rail. Field trimmable with carbide blade. Includes bottom finishing plate. Series 400 top rail is designed to allow for the attachment of a wood or composite cap rail. Cap rail **MUST add 1/2"** to overall rail height to reach required rail heights for both 36" and 42" rails.

94" Top Rail (2-7/8" x 1-1/4" x 94")

Item #: FXTR400BLK8KIT - Black
Item #: FXTR400BRZ8KIT - Bronze
Item #: FXTR400WHT8KIT - White
Item #: FXTR400SIL8KIT - Silver



*Wood cap rail not included

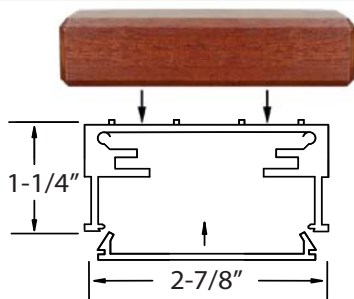

Available in:

Black

Bronze

White

Silver

Series 400 Top Rail End Plate

Sold in any quantity.

Aluminum end plate required to cap series 400 top rail ends for a finished look. Includes 2 color matched screws.

Item #: FXEP400BLK - Black
Item #: FXEP400BRZ - Bronze
Item #: FXEP400WHT - White
Item #: FXEP400SIL - Silver



ACTUAL FREIGHT CHARGES WILL BE APPLIED TO RAILFX® ORDERS

RailFX® Series 400 Rail Splices

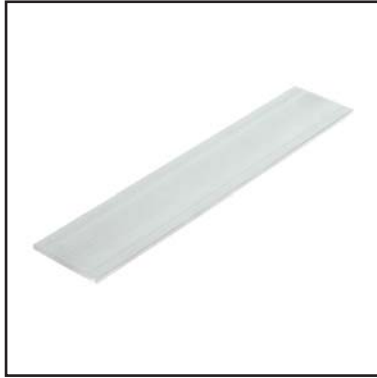

Available in:

Aluminum

Straight Splice - 400 Series

Sold in any quantity.

9" long splice joins straight sections of series 400 top rail to make any length run. Splices can be used between posts or directly on top of posts. Installs using 8 - #10 x 3/4" self-drilling screws (Not Included)

Item # FXSPL400LEVEL

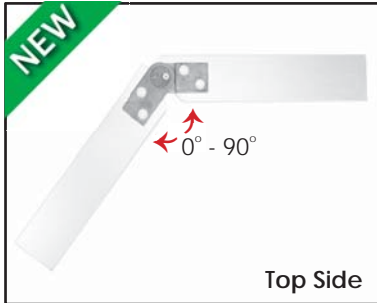

Top Side

Available in:

Aluminum

Universal Splice - 400 Series

Sold in any quantity.

Universal Level Splice for 400 Series top rail adjusts to accommodate for any angle from 0° - 90°. Requires miter cutting of top rail. Installs using 8 - #10 x 3/4" self-drilling screws (Not Included)

Item #: FXSPL400UNIVERSL - Universal Splice 400



Bottom Side



Top Side

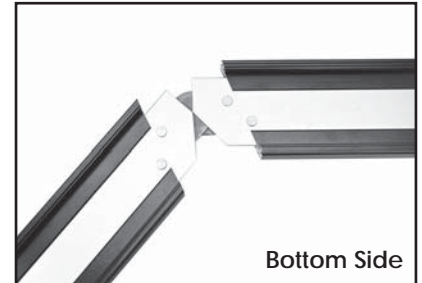

Bottom Side

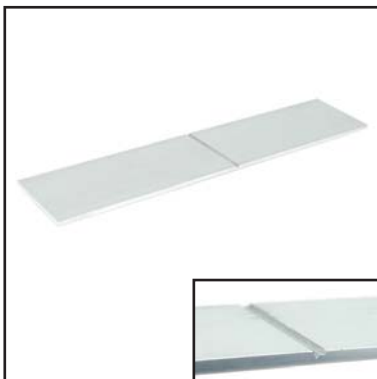

Available in:

Aluminum

Stair Splice - 400 Series

Sold in any quantity.

For continuous level to stair transition. Bends to accommodate any angle from 0° - 38°. Requires miter cutting of top rail. Installs using 8 - #10 x 3/4" self-drilling screws (Not Included)

Item # FXSPL400STAIR



ACTUAL FREIGHT CHARGES WILL BE APPLIED TO RAILFX® ORDERS



RailFX® Aluminum Rail and Cable - Silver - Series 250 (Graspable Stair)

RailFX® Series 250 Graspable Top Rail for Stair

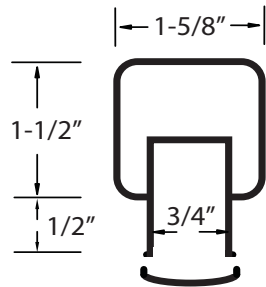

Available in:

Black

Bronze

White

Silver

Series 250 Top Rail for Stairs

Sold in any quantity.

2" x 1-5/8" x 94" Series 250 aluminum top rail. Qualifies as continuous graspable handrail when used with intermediate post fitting. Field trimmable with carbide blade. Includes bottom finishing plate for clean look. Requires IPF fitting for mounting over the post. **End plate sold separately.**

94" Top Rail (2" x 1-5/8" x 94")

Item #: FXTR250BLK8KIT - Black
Item #: FXTR250BRZ8KIT - Bronze
Item #: FXTR250WHT8KIT - White
Item #: FXTR250SIL8KIT - Silver



Available in:

Black

Bronze

White

Silver

Series 250 Top Rail End Plate

Sold in any quantity.

Aluminum end plate required to cap series 250 top rail ends for a finished look. Use adhesive to attach to rail.

Item #: FXEP250BLK - Black
Item #: FXEP250BRZ - Bronze
Item #: FXEP250WHT - White
Item #: FXEP250SIL - Silver



ACTUAL FREIGHT CHARGES WILL BE APPLIED TO RAILFX[®] ORDERS



Available in:

- Black
- Bronze
- White
- Silver

Intermediate Post Fitting (IPF)

Sold in any quantity.

Used on stair posts for over the post mounting style of series 250 top rail. Fitting attaches to the top of post and allows for top rail to be installed at any angle. Measures 3/4" W x 1-1/2" L x 2" H.

- Item #: FXIPFSETBLK - Black
- Item #: FXIPFSETBRZ - Bronze
- Item #: FXIPFSETWHT - White
- Item #: FXIPFSETSIL - Silver



Available in:

- Aluminum

Rail Connector Block

Sold in any quantity.

Used to terminate series 250 top rail into post. It can also be used to splice series 250 top rail together. When splicing, use 8 color matched screws to secure in place (Not Included). Can be used for level and stair applications. Screws included.

- Item #: FXRCB12 - 12" Connector Block
- Item #: FXRCB1 - 1" Connector Block

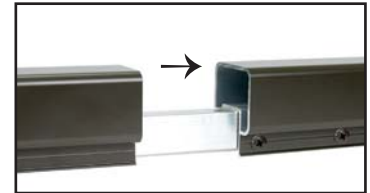

Available in:

- Black
- Bronze
- White
- Silver

Series 250 End Plate Bracket

Sold in any quantity.

Aluminum end plate bracket used to connect series 250 top rails to series 200 top rail when using a single corner post at the top of a stair run. Allows for single corner post use and the use of series 250 graspable top rail for stairs. Includes 4 color matched screws.

- Item #: FXEPB250BLK - Black
- Item #: FXEPB250BRZ - Bronze
- Item #: FXEPB250WHT - White
- Item #: FXEPB250SIL - Silver



Item #: FXRCB1 - 1" Connector Block



ACTUAL FREIGHT CHARGES WILL BE APPLIED TO RAILFX® ORDERS



Available in:

- Black
- Bronze
- White
- Silver

Series 400 End Plate Bracket

Sold in any quantity.

Aluminum end plate bracket used to connect series 250 top rails to series 400 top rail when using a single corner post at the top of a stair run. Allows for single corner post use and the use of series 250 graspable top rail for stairs. Includes 4 color matched screws.

- Item #: FXEPB400BLK - Black
- Item #: FXEPB400BRZ - Bronze
- Item #: FXEPB400WHT - White
- Item #: FXEPB400SIL - Silver

Item #: FXRCB1 - 1" Connector Block



Available in:

- Black
- Bronze
- White
- Silver

Series 200 Extended End Plate

Sold in any quantity.

Aluminum extended end plate used to connect series 250 top rails to series 200 top rail. Allows for the top rails to transition from level to stair when running cable in-line through a single post at the top of a stair run. Includes 2 color matched screws.

- Item #: FXEXP200BLK - Black
- Item #: FXEXP200BRZ - Bronze
- Item #: FXEXP200WHT - White
- Item #: FXEXP200SIL - Silver

Item #: FXRCB1 - 1" Connector Block

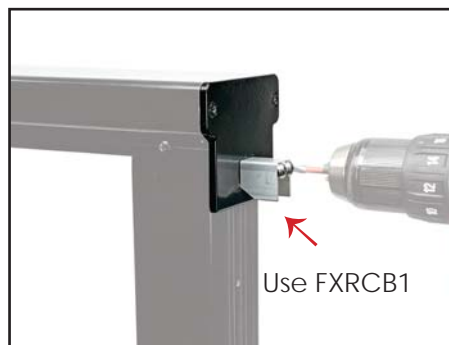

ACTUAL FREIGHT CHARGES WILL BE APPLIED TO RAILFX® ORDERS



Available in:

Black

Bronze

White

Silver

Series 400 Extended End Plate

Sold in any quantity.

Aluminum extended end plate used to connect series 250 top rails to series 400 top rail. Allows for the top rails to transition from level to stair when running cable in-line through a single post at the top of a stair run. Includes 2 color matched screws.

Item #: FXEXP400BLK - Black
Item #: FXEXP400BRZ - Bronze
Item #: FXEXP400WHT - White
Item #: FXEXP400SIL - Silver

Item #: FXRCB1 - 1" Connector Block

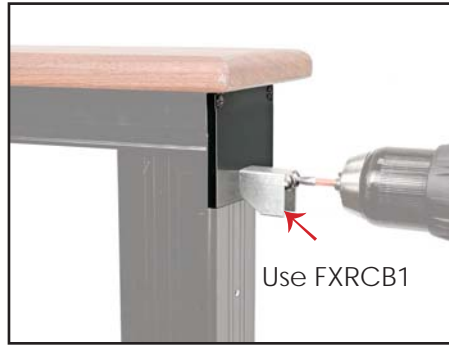

Available in:

Black

Bronze

White

Silver

Series 200 End Plate Bracket

Sold in any quantity.

Aluminum end plate bracket used to connect series 200 top rails perpendicularly. Used at the top of the stair where the level and stair rails meet at 90 degrees. Allows for single corner post use at top of stairs. Can also be used for level 90 degree connections. Includes 4 color matched screws.

Item #: FXEPB200BLK - Black
Item #: FXEPB200BRZ - Bronze
Item #: FXEPB200WHT - White
Item #: FXEPB200SIL - Silver

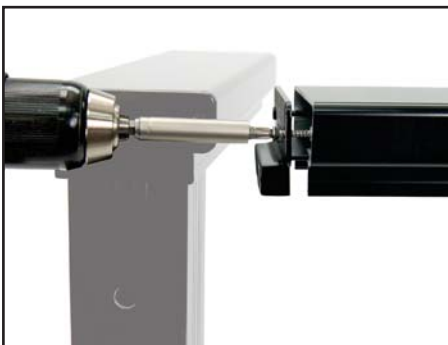

ACTUAL FREIGHT CHARGES WILL BE APPLIED TO RAILFX® ORDERS

RailFX® Top Post Plates to Attach Wood Cap Rail



Available in:

Black

Bronze

White

Silver

Level Top Plate

Sold in any quantity.

Plate mounts to the top of level posts to accommodate various top rails to be attached. Top rail must be structural and meet code requirements. Measures 3" x 5" x 3/8". Includes hardware to attach to post. Use T40 torx bit for installation.

Item #: **FXTP3X5L2HBLK** - Black
Item #: **FXTP3X5L2HBRZ** - Bronze
Item #: **FXTP3X5L2HWHT** - White
Item #: **FXTP3X5L2HSIL** - Silver



Available in:

Black

Bronze

White

Silver

Corner Top Plate

Sold in any quantity.

Plate mounts to the top of level corner posts to accommodate various top rails to be attached. Top rail must be structural and meet code requirements. Measures 5" x 5" x 3/8". Includes hardware to attach to post. Use T40 torx bit for installation.

Item #: **FXTPCORNER2HBLK** - Black
Item #: **FXTPCORNER2HBRZ** - Bronze
Item #: **FXTPCORNER2HWHT** - White
Item #: **FXTPCORNER2HSIL** - Silver



Available in:

Black

Bronze

White

Silver

Stair Top Plate

Sold in any quantity.

Plate mounts to the top of stair posts to accommodate various top rails to be attached. Top rail must be structural and meet code requirements. Measures 3" x 5" x 3/8". Includes hardware to attach to post. Use T40 torx bit for installation.

Item #: **FXTP3X5S1HBLK** - Black
Item #: **FXTP3X5S1HBRZ** - Bronze
Item #: **FXTP3X5S1HWHT** - White
Item #: **FXTP3X5S1HSIL** - Silver

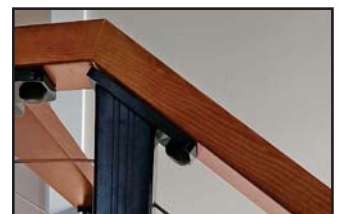

Available in:

Black

Bronze

White

Silver

Adjustable Top Plate

Sold in any quantity.

Adjustable plate mounts to the top of post to accommodate various top rails to be attached. Articulating plate can adjust up / down and pivot at angle. Can be used for level or stair applications. Top rail must be structural and meet code requirements. Includes hardware to attach to post. Mounting plate measures 1-1/2" W x 5" L.

Item #: **FXIPFADJSETBLK** - Black
Item #: **FXIPFADJSETBRZ** - Bronze
Item #: **FXIPFADJSETWHT** - White
Item #: **FXIPFADJSETSIL** - Silver



ACTUAL FREIGHT CHARGES WILL BE APPLIED TO RAILFX® ORDERS

RailFX® Surface Mount Posts



Available in:

Black

Bronze

White

Silver

Surface Mount End Post - Pre-Drilled

Sold in any quantity.

2-3/8" Square surface mount post with 5" base plate. Base plate has 3/8" holes spaced 3-3/4" on center for fasteners. Pre-drilled at 3-3/16" on center spacing w/ 29/64" holes. 10 holes for 36" rail, 12 holes for 42" rail. Engineered to meet code with posts at 60" on center spacing. Includes 4 ea. bolt cap covers. **Fasteners sold separately.**

36" Rail Height (2-3/8" x 35")

Item #: FXCEP200BLK35KIT - Black
Item #: FXCEP200BRZ35KIT - Bronze
Item #: FXCEP200WHT35KIT - White
Item #: FXCEP200SIL35KIT - Silver

42" Rail Height (2-3/8" x 41")

Item #: FXCEP200BLK41KIT - Black
Item #: FXCEP200BRZ41KIT - Bronze
Item #: FXCEP200WHT41KIT - White
Item #: FXCEP200SIL41KIT - Silver

Base Plate Post Skirts are Available
See page 141



Available in:

Black

Bronze

White

Silver

Surface Mount Intermediate Post - Pre-Drilled

Sold in any quantity.

2-3/8" Square surface mount post with 5" base plate. Base plate has 3/8" holes spaced 3-3/4" on center for fasteners. Pre-drilled at 3-3/16" on center spacing w/ 5/32" holes. 10 holes for 36" rail, 12 holes for 42" rail. Engineered to meet code with posts at 60" on center spacing. Includes 4 ea. bolt cap covers. **Fasteners sold separately.**

36" Rail Height (2-3/8" x 35")

Item #: FXCIP200BLK35KIT - Black
Item #: FXCIP200BRZ35KIT - Bronze
Item #: FXCIP200WHT35KIT - White
Item #: FXCIP200SIL35KIT - Silver

42" Rail Height (2-3/8" x 41")

Item #: FXCIP200BLK41KIT - Black
Item #: FXCIP200BRZ41KIT - Bronze
Item #: FXCIP200WHT41KIT - White
Item #: FXCIP200SIL41KIT - Silver

Base Plate Post Skirts are Available
See page 141



ACTUAL FREIGHT CHARGES WILL BE APPLIED TO RAILFX® ORDERS

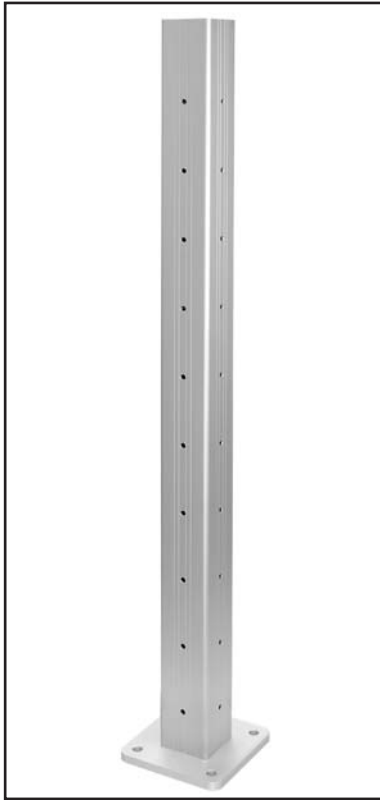

Available in:

- Black
- Bronze
- White
- Silver

Surface Mount Single Corner Post - Pre-Drilled

Sold in any quantity.

2-3/8" Square surface mount post with 5" base plate. Base plate has 3/8" holes spaced 3-3/4" on center for fasteners. Pre-drilled at 3-3/16" on center spacing w/ 1/4" holes. 10 holes for 36" rail, 12 holes for 42" rail. Engineered to meet code with posts at 60" on center spacing. Includes 4 ea. bolt cap covers and round internal tube. **Fasteners sold separately.**

36" Rail Height (2-3/8" x 35")

Item #: FXCCP200BLK35KIT - Black
Item #: FXCCP200BRZ35KIT - Bronze
Item #: FXCCP200WHT35KIT - White
Item #: FXCCP200SIL35KIT - Silver

42" Rail Height (2-3/8" x 41")

Item #: FXCCP200BLK41KIT - Black
Item #: FXCCP200BRZ41KIT - Bronze
Item #: FXCCP200WHT41KIT - White
Item #: FXCCP200SIL41KIT - Silver

Base Plate Post Skirts are Available
See next page

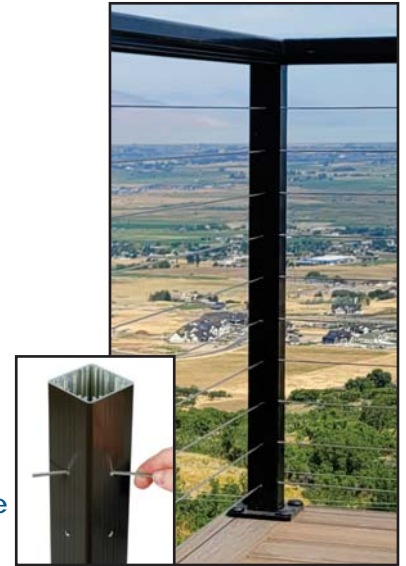

Available in:

- Black
- Bronze
- White
- Silver

Pre-Drilled Post for Stair Applications

Sold in any quantity.

2-3/8" Square Pre-drilled stair post for cable system. Due to many variables in stairs, these posts do not come with base plate attached. This allows post to be placed, adjusted and mounted where desired. Stair post holes are slotted and drilled at 3-3/16" on center and offset to allow cables to pass through at the angle of the stair. 46" length allows post to be cut to appropriate height.

36" Rail Height (2-3/8" x 46")

Item #: FXFMSCIP200BLK46 - Black
Item #: FXFMSCIP200BRZ46 - Bronze
Item #: FXFMSCIP200WHT46 - White
Item #: FXFMSCIP200SIL46 - Silver

42" Rail Height (2-3/8" x 52")

Item #: FXFMSCIP200BLK52 - Black
Item #: FXFMSCIP200BRZ52 - Bronze
Item #: FXFMSCIP200WHT52 - White
Item #: FXFMSCIP200SIL52 - Silver

Requires Base Plate for Surface Mounting
Reference next page



ACTUAL FREIGHT CHARGES WILL BE APPLIED TO RAILFX® ORDERS

RailFX® Post Skirts & Base Plates



Available in:

Black

Bronze

White

Silver

Post Skirt

Sold in any quantity.

2 Piece post skirt to cover standard 5" x 5" post baseplate and hardware. Measures 5-1/4" x 1-5/8" with 2-3/8" opening.

Item # FXSKIRTLBK - Black
Item # FXSKIRTBRZ - Bronze
Item # FXSKIRTWHT - White
Item # FXSKIRTSIL - Silver

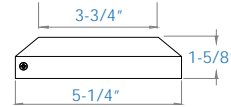

Available in:

Black

Bronze

White

Silver

5" x 5" Standard Base Plate

Sold in any quantity.

5" x 5" x 3/8" Aluminum base plate used to convert fascia posts to surface mount post for stair applications. Base plate has 3/8" holes spaced 3-3/4" on center for fasteners. Includes 4 ea. bolt cap covers and 4 ea. 5/16" x 2" stainless steel screws. Use T40 torx bit for installation.

Item #: FXBPBLKKIT - Black
Item #: FXBPBRZKIT - Bronze
Item #: FXBPWHTKIT - White
Item #: FXBPSILKIT - Silver

Item # FXINSTKIT - Post Base Install Kit



Available in:

Black

Bronze

White

Silver

3" x 5" Narrow Base Plate

Sold in any quantity.

3" x 5" x 3/8" Aluminum base plate used to convert fascia posts to surface mount post. Base plate holes for fasteners are 3/8". Includes 4 ea. bolt cap covers and 4 ea. 5/16" x 2" stainless steel screws. Use T40 torx bit for installation. No post skirt option.

Item #: FXBP3X5BLKKIT - Black
Item #: FXBP3X5BRZKIT - Bronze
Item #: FXBP3X5WHTKIT - White
Item #: FXBP3X5SILKIT - Silver

Item # FXINSTKIT - Post Base Install Kit



Available in:

Black

Bronze

White

Silver

3" x 7" Narrow Angle / Knee Wall Base Plate

Sold in any quantity.

3" x 7" x 3/8" Slotted, adjustable aluminum base plate used for 2x4 knee wall applications (32° - 38°). Base plate holes for fasteners are 3/8". Includes 4 ea. bolt cap covers and 4 ea. 5/16" x 2" stainless steel screws. Use T40 torx bit for installation. Requires grinding of bolt head for flush bottom. No post skirt option.

Item #: FXBP3X7KWBLKKIT - Black
Item #: FXBP3X7KWBRZKIT - Bronze
Item #: FXBP3X7KWWHTKIT - White
Item #: FXBP3X7KWSILKIT - Silver

Item # FXINSTKIT - Post Base Install Kit

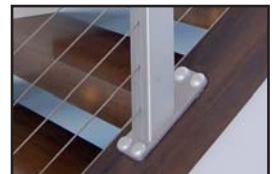

ACTUAL FREIGHT CHARGES WILL BE APPLIED TO RAILFX® ORDERS

RailFX® Fascia Mount Posts and Brackets

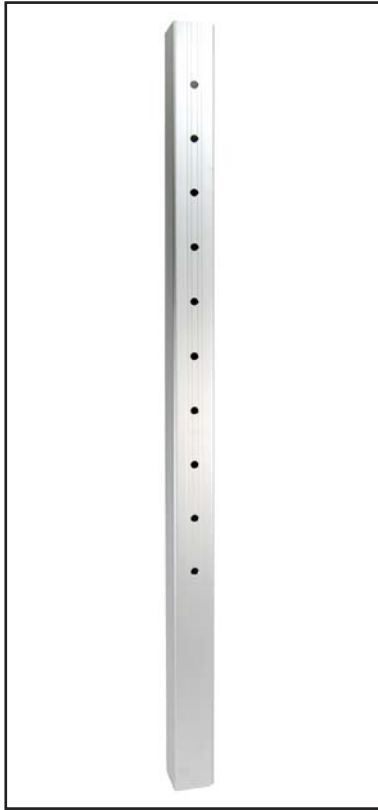

Available in:

Black

Bronze

White

Silver

Fascia Mount End Post - Pre-Drilled

Sold in any quantity.

2-3/8" Square fascia mount post for use as an end post. Pre-drilled at 3-3/16" on center spacing w/ 29/64" holes. 10 holes for 36" rail, 12 holes for 42" rail. Engineered to meet code with posts at 60" on center spacing. **Fascia brackets sold separately.**

36" Rail Height (2-3/8" x 46")

Item #: FXFMCEP200BLK46 - Black
Item #: FXFMCEP200BRZ46 - Bronze
Item #: FXFMCEP200WHT46 - White
Item #: FXFMCEP200SIL46 - Silver

42" Rail Height (2-3/8" x 52")

Item #: FXFMCEP200BLK52 - Black
Item #: FXFMCEP200BRZ52 - Bronze
Item #: FXFMCEP200WHT52 - White
Item #: FXFMCEP200SIL52 - Silver

*Undrilled Post Available
See Page 144



Available in:

Black

Bronze

White

Silver

Fascia Mount Intermediate Post - Pre-Drilled

Sold in any quantity.

2-3/8" Square fascia mount post for use as an intermediate post. Pre-drilled at 3-3/16" on center spacing w/ 5/32" holes. 10 holes for 36" rail, 12 holes for 42" rail. Engineered to meet code with posts at 60" on center spacing. **Fascia brackets sold separately.**

36" Rail Height (2-3/8" x 46")

Item #: FXFMCIP200BLK46 - Black
Item #: FXFMCIP200BRZ46 - Bronze
Item #: FXFMCIP200WHT46 - White
Item #: FXFMCIP200SIL46 - Silver

42" Rail Height (2-3/8" x 52")

Item #: FXFMCIP200BLK52 - Black
Item #: FXFMCIP200BRZ52 - Bronze
Item #: FXFMCIP200WHT52 - White
Item #: FXFMCIP200SIL52 - Silver





*Undrilled Post Available
See Page 144



ACTUAL FREIGHT CHARGES WILL BE APPLIED TO RAILFX® ORDERS

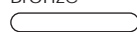

Available in:

-  Black
-  Bronze
-  White
-  Silver

Pre-Drilled - Fascia Mount Stair Post

Sold in any quantity.

2-3/8" Square fascia mount post for use as an intermediate stair post. Stair post holes are slotted and drilled at 3-3/16" on center and offset to allow cables to pass through at the angle of the stair. **Fascia brackets sold separately.**

36" Rail Height (2-3/8" x 46")

- Item #: FXFMSCIP200BLK46 - Black
- Item #: FXFMSCIP200BRZ46 - Bronze
- Item #: FXFMSCIP200WHT46 - White
- Item #: FXFMSCIP200SIL46 - Silver

42" Rail Height (2-3/8" x 52")



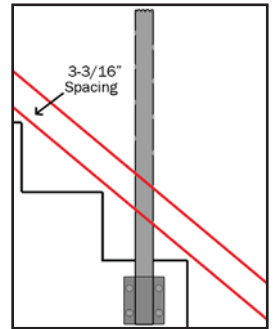

- Item #: FXFMSCIP200BLK52 - Black
- Item #: FXFMSCIP200BRZ52 - Bronze
- Item #: FXFMSCIP200WHT52 - White
- Item #: FXFMSCIP200SIL52 - Silver

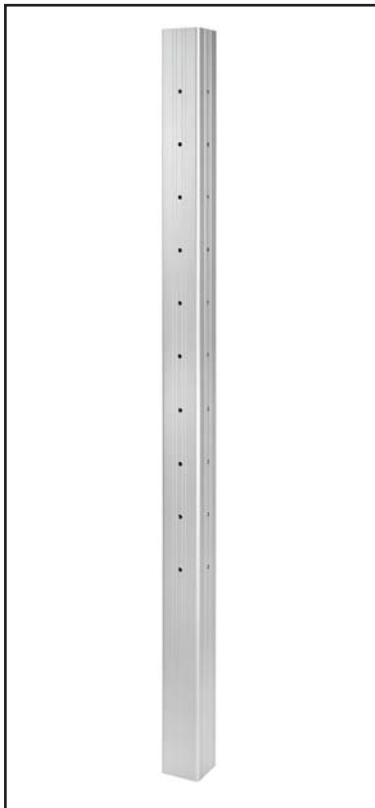

*Undrilled Post Available
See Page 144

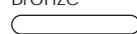

Available in:

-  Black
-  Bronze
-  White
-  Silver

Fascia Mount Single Corner Post - Pre-Drilled

Sold in any quantity.

2-3/8" Square fascia mount post for use as a single corner post. Pre-drilled at 3-3/16" on center spacing w/ 1/4" holes. 10 holes for 36" rail, 12 holes for 42" rail. Includes round internal tube. Engineered to meet code with posts at 60" on center spacing. **Fascia brackets sold separately.**

36" Rail Height (2-3/8" x 46")

- Item #: FXFMCCP200BLK46 - Black
- Item #: FXFMCCP200BRZ46 - Bronze
- Item #: FXFMCCP200WHT46 - White
- Item #: FXFMCCP200SIL46 - Silver

42" Rail Height (2-3/8" x 52")

- Item #: FXFMCCP200BLK52 - Black
- Item #: FXFMCCP200BRZ52 - Bronze
- Item #: FXFMCCP200WHT52 - White
- Item #: FXFMCCP200SIL52 - Silver







*Undrilled Post Available
See Page 144

ACTUAL FREIGHT CHARGES WILL BE APPLIED TO RAILFX® ORDERS



Available in:

-  Black
-  Bronze
-  White
-  Silver

Undrilled Post

Sold in any quantity.

2-3/8" x 52" Square post works for 36" and/or 42" rail heights. Post can be used for fascia mount and/or surface mount applications. Base plate sold separately for surface mount.

52" Undrilled Post (2-3/8" x 52")

- Item #: FXFMP200BLK52 - Black
- Item #: FXFMP200BRZ52 - Bronze
- Item #: FXFMP200WHT52 - White
- Item #: FXFMP200SIL52 - Silver

Requires Base Plate for Surface Mounting
See Page 141

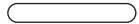

Available in:

-  Black
-  Bronze
-  White
-  Silver

6" Fascia Bracket



Sold in any quantity.

Mounts 2-3/8" post to deck fascia. Bracket offsets post 1-1/4" out from fascia. Includes 4 fascia screws, 4 bolt cap covers and 1 bottom plate w/ screws. Mounting hardware is not included.

- Item # FXFMIPB200BLK - Black
- Item # FXFMIPB200BRZ - Bronze
- Item # FXFMIPB200WHT - White
- Item # FXFMIPB200SIL - Silver



Available in:

-  Black
-  Bronze
-  White
-  Silver

Fascia Bracket - Single Outside Corner

Sold in any quantity.

Mounts 2-3/8" post to deck fascia for an outside corner. Bracket offsets post 1-1/4" out from fascia. Includes 4 fascia screws, 4 bolt cap covers and 1 bottom plate w/ screws. Mounting hardware is not included.

- Item # FXFMOCBSINGLEBLK - Black
- Item # FXFMOCBSINGLEBRZ - Bronze
- Item # FXFMOCBSINGLEWHT - White
- Item # FXFMOCBSINGLELIL - Silver



ACTUAL FREIGHT CHARGES WILL BE APPLIED TO RAILFX® ORDERS



Available in:

Black

Bronze

White

Silver

Fascia Bracket - Inside Corner

Sold in any quantity.

Mounts 2-3/8" post to deck fascia for an inside corner. Bracket offsets post 1-1/4" out from fascia. Includes 4 fascia screws, 4 bolt cap covers and 1 bottom plate w/ screws. Mounting hardware is not included.

Item #: FXFMICBSINGLEBLK - Black
Item #: FXFMICBSINGLEBRZ - Bronze
Item #: FXFMICBSINGLEWHT - White
Item #: FXFMICBSINGLESIL - Silver



Available in:

Black

Bronze

White

Silver

Fascia Bracket - Double Outside Corner

Sold in any quantity.

Mounts 2-3/8" posts to deck fascia. This bracket is required to maintain 4" spacing on outside corners when using 2 posts. Bracket offsets post 1-1/4" out from fascia. Includes 8 fascia screws, 4 bolt cap covers and 2 bottom plates w/ screws. Mounting hardware is not included.

Item #: FXFMOCB200BLK - Black
Item #: FXFMOCB200BRZ - Bronze
Item #: FXFMOCB200WHT - White
Item #: FXFMOCB200SIL - Silver

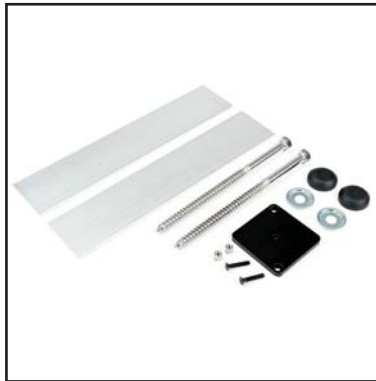

Available in:

Black

Bronze

White

Silver

Direct Mount Fascia Post Kit

Sold in any quantity.

Components needed to flush mount 2-3/8" post directly to deck fascia. Includes 2 ea. 7" lag screws, 2 ea. bolt cap covers w/ cup washer, 2 ea. 10" flat infill, and 1 ea. bottom cover plate w/ screws.

Item # FXFMFINSTKITBLK - Black
Item # FXFMFINSTKITBRZ - Bronze
Item # FXFMFINSTKITWHT - White
Item # FXFMFINSTKITSIL - Silver



RailFX® Aluminum Rail and Cable w/ Fascia Mount Brackets - Black

ACTUAL FREIGHT CHARGES WILL BE APPLIED TO RAILFX® ORDERS

RailFX® Under Rail Lighting System

Series 200 Top Rail



Available in:

- Black
- Bronze
- White
- Silver

Series 200 Top Rail

Sold in any quantity.

3-1/2" x 1-7/8" x 94" Series 200 aluminum top rail. Join multiple rails together with splices to achieve any length required. Field trimmable with carbide blade. Infill for lighting sold separately, see below.

End plate sold separately.

8' Top Rail (3-1/2" x 1-7/8" x 94")

- Item #: FXTR200BLKKIT8 - Black
- Item #: FXTR200BRZKIT8 - Bronze
- Item #: FXTR200WHTKIT8 - White
- Item #: FXTR200SILKIT8 - Silver



Available in:

- Black
- Bronze
- White
- Silver

60" Top Rail Lighting Infill

Sold in any quantity.

Infill installs into the bottom of series 200 top rail. Designed with a channel that allows for lighting to be added. Lights and diffuser lens sold separately (See next page). Field trimmable with carbide blade.

- Item #: FXFIG200BLK5 - Black
- Item #: FXFIG200BRZ5 - Bronze
- Item #: FXFIG200WHT5 - White
- Item #: FXFIG200SIL5 - Silver



ACTUAL FREIGHT CHARGES WILL BE APPLIED TO RAILFX[®] ORDERS



DekProTM EFFEX LED Light Strip

Sold in any quantity.

Light strip uses 3M adhesive backing to attach to inside of infill channel. Trimmable to length in 2" increments. Features 2 quick connect leads for easy wiring.

Item #: DP5L55 - 55" Strip Light (4.5 Watts)



DekPro Quick Connect System

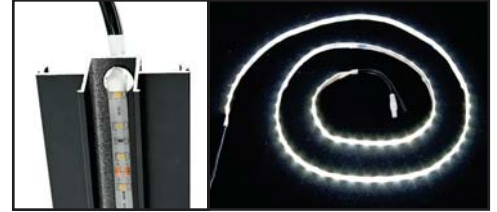

60" Diffuser Lens

Sold in any quantity.

Diffuser lens snaps onto rail to produce a soft, even light that illuminates cables and deck surface.

Item #: FXFILENS60 - 60" Diffuser Lens



DekProTM EFFEX Transformer Kit

Sold in any quantity.

Kit includes 1 Outdoor DC output transformer w/ Quick Connect lead, 1 timer / photo cell, 1 dimmer with remote control, 1 Y-splitter and 1 - 9' Quick Connect wire. Dimmer draws **2.5 watts**. Determine correct transformer size by adding up wattage of all fixtures. Total wattage should not exceed 80% of the capacity of the transformer. (100 watt transformer has two outputs).

Item # DP36WTRANSKIT - 36 watt transformer kit
Item # DP60WTRANSKIT - 60 watt transformer kit
Item # DP100WTRANSKIT - 100 watt transformer kit



DekPro Quick Connect System



DekProTM EFFEX 9' Quick Connect Cable

Sold in any quantity.

9' Cables come with water tight Quick Connect fittings on each end. Cables connect into DekProTM EFFEX lighting components. Used when running wiring through top rail of aluminum railing system (i.e. DekProTM Prestige)

Item # DP9CABLEMF



DekPro Quick Connect System

ACTUAL FREIGHT CHARGES WILL BE APPLIED TO RAILFX® ORDERS

RailFX® Accessories



Available in:

Black

Bronze

White

Silver

Bolt Cap Cover Kit - Replacement

Sold in packs of 4.

Covers lag screw heads for a clean, finished look. Includes nylon cap and stainless steel cup washer.

Item #: FXBOLTCAPBLKKIT - Black
Item #: FXBOLTCAPBRZKIT - Bronze
Item #: FXBOLTCAPWHTKIT - White
Item #: FXBOLTCAPSILKIT - Silver



5"

Available in:

Stainless Steel

Stainless Steel Lag Screw for Post Base

Sold in any quantity.

3/8" Lag used to attach post base to deck or for mounting fascia posts. Use 9/16" socket.

Item #: FXSCREWLAG5 - 5" Lag Screw (Surface mount)
Item #: FXSCREWLAG7 - 7" Lag Screw (Fascia mount w/o brackets)



7"



Available in:

Stainless Steel

Fascia Bracket Screw - Replacement

Sold in any quantity.

#14 x 1" Hex head stainless steel fascia bracket screw. Use for securing post to fascia bracket. Requires 4 per bracket. Brackets come with screws - these are for replacement only. Use 3/8" socket.

Item #: FXSSFS - Fascia Screw



Available in:

Black

Bronze

White

Stainless Steel

Color Matched Screws

Sold in 100 Pack.

#10 - 3/4" phillips head screw attaches top rail to posts, and also used for splices.

Item #: FXSCREWBKWK805 - Black
Item #: FXSCREWBKWK805 - Bronze
Item #: FXSCREWWHTW805 - White
Item #: FXSCREWSW805 - Stainless Steel

ACTUAL FREIGHT CHARGES WILL BE APPLIED TO RAILFX® ORDERS



- Available in:
- Absolute Black
 - Cocoa Bronze
 - Dream White
 - Silver

DekPro™ EFFEX Vertical Post Light for RailFX Post

Sold in any quantity.

EFFEX LED Vertical Post Light is great for illuminating decks or walkways. Includes 2 ea. - 3' Quick Connect leads. Draws **1 watts** per fixture. Measures 3-1/2"H x 1-3/4"W x 7/8"T. Light color - 3500.

- Item # DPPLABT - Absolute Black (Textured)
- Item # DPPLCBT - Cocoa Bronze (Textured)
- Item # DPPLDWT - Dream White (Textured)
- Item # DPPLSIL - Silver



See pages 248-249 for power and wiring options



- Available in:
- Black
 - Bronze
 - White
 - Silver

2-3/8" Post Cap

Sold in any quantity.

Use to finish 2-3/8" post. Use screws or epoxy to secure to post. Typically used if Series 250 top rails end into side of post.

- Item #: FXPCBLK - Black
- Item #: FXPCBRZ - Bronze
- Item #: FXPCWHT - White
- Item #: FXPCSIL - Silver



- Available in:
- Black
 - Bronze
 - White
 - Silver

Touch-Up Paint

Sold in any quantity.

Touch up paint available to cover up scratches and cuts from installation.

Spray Can (6 oz)

- Item #: FXPAINTBLK - Black
- Item #: FXPAINTBRZ - Bronze
- Item #: FXPAINTWHT - White
- Item #: FXPAINTSIL - Silver

RailFX® Cable Installation Tools



Cable Cutters

Sold in any quantity.

Cable cutter designed for clean, burr free cutting of 1/8" stainless steel cable.

- Item #: RFXC7HIT

ACTUAL FREIGHT CHARGES WILL BE APPLIED TO RAILFX® ORDERS



Cable Gripping Pliers

Sold in any quantity.

Used to securely grip cable to avoid winding during installation which eliminates the most common issue of cables losing tension. Cable gripping pliers are recommended for professional installers.

Item #: RFXPLIERS



Push Lock Release Key

Sold in any quantity.

Release key allows the release of an untensioned cable from Pull-Lock™ fitting. Also used to release fittings to aid installation.

Item #: RFXPLKEY/R

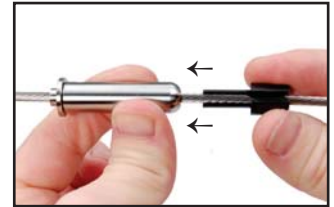

Cable Lacing Needle

Sold in any quantity.

Used to pass 1/8" cable through posts without snagging / fraying during installation. Fits 3/16" diameter hole or larger.

Item # RFXNEEDLE - Cable Lacing Needle

Item # RFXNEEDLECURVED - Curved Lacing Needle



Cable Pre-Tensioner Tool

Sold in any quantity.

Cable pre-tensioner tool is typically needed when using long runs of cable (Over 50') with multiple turns. This tool pulls the cables to tension to easily allow the installer to feed the cable into the non-tensioning cable fitting. Hand ratchet is used to rotate threaded rod to pull tension on the cable. **Do not** use power tools.

Item # FXPRETENSIONER01



ACTUAL FREIGHT CHARGES WILL BE APPLIED TO RAILFX® ORDERS



RailFX® Fascia Mount w/ Brackets



RailFX® Direct Mount Fascia Posts



RailFX® Adjustable Top Plate - Interior



RailFX® Under-Rail Lighting



RailFX® with Existing Wood Posts



RailFX® Series 400 / 250 Top Rail

RailFX® Oasis™ Cable Railing



Post to Post Cable Railing System

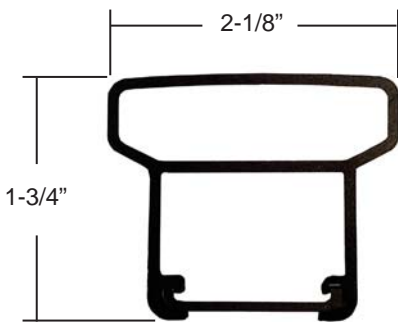
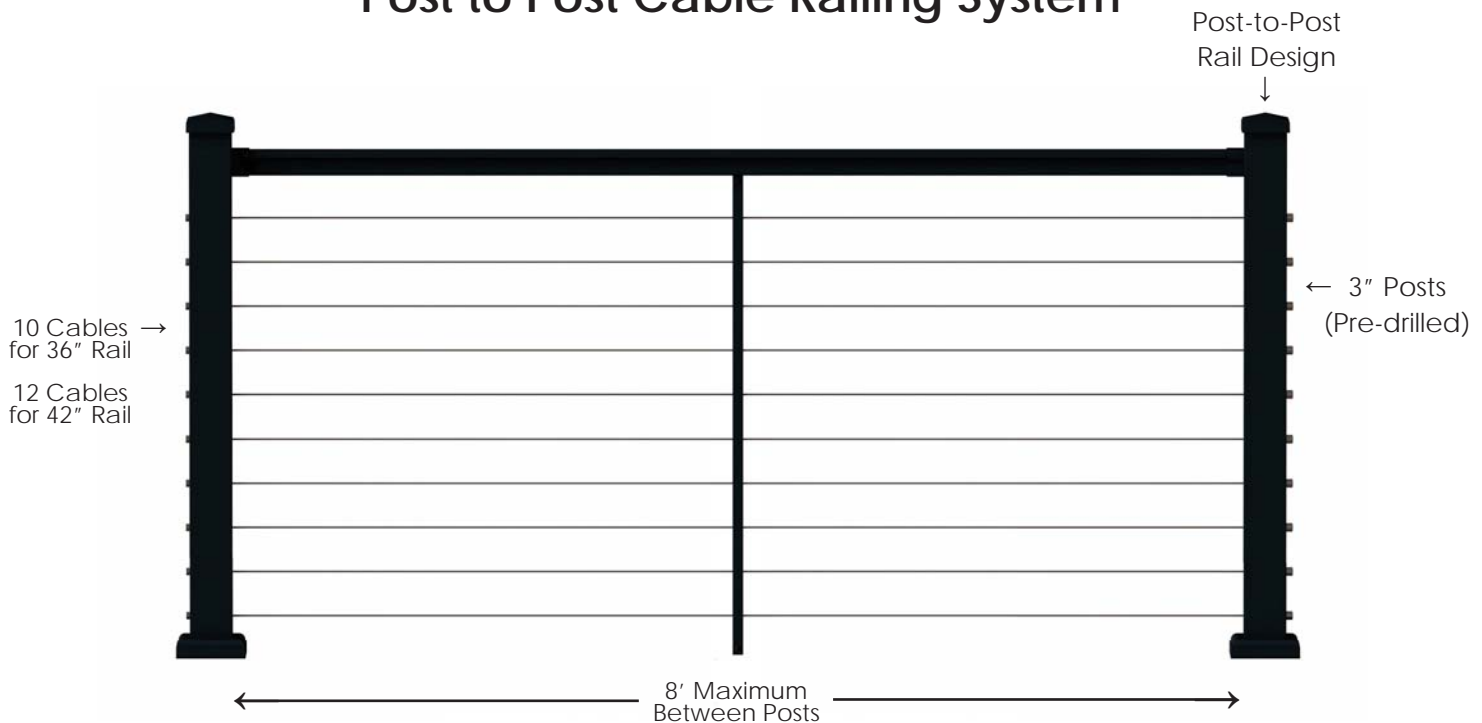

Top Rail Profile

- Post-to-Post Style
- 3" Pre-Drilled Posts - Surface Mount
- 8' Post Spacing w/ Cable Brace in the Middle
- Level Posts are Pre-Drilled for Brackets
- 10 runs of cable for 36" rail, 12 runs of cable for 42" rail
- Interior / Exterior Use
- Black Textured Powder Coat Finish

RailFX® Oasis™ Aluminum Cable Railing System

RailFX® Oasis™ cable railing system an aluminum rail with finely textured black powder coat finish. 3" Posts are all pre-drilled for cable railing and posts can be spaced up to 8' apart. RailFX® Oasis™ brings simplicity and style together, allowing you to effortlessly achieve the perfect outdoor sanctuary. Made of extruded aluminum that will never rust, it is built to withstand the test of time with minimal maintenance.

ACTUAL FREIGHT CHARGES WILL BE APPLIED TO RAILFX® ORDERS

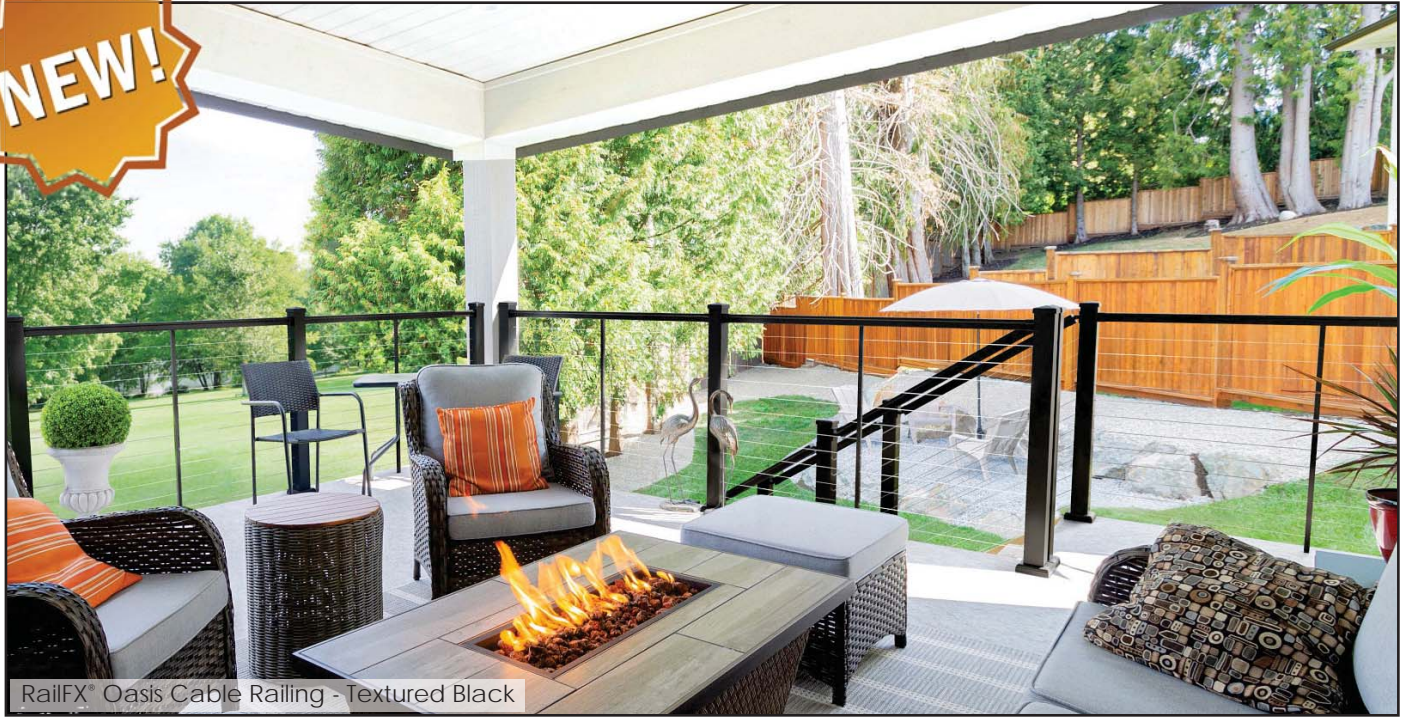

RailFX® Oasis Cable Railing - Textured Black

DekPro™ InvisiCable for Oasis Cable Railing



InvisiCable™ Kit for Oasis

Sold in kits.

Cable railing kit made from 1/8" high quality 316 grade stainless steel. Includes 1 strand of cable with 2.75" threaded stud on one end, Pull-Lock™ fitting, washers, nut and 2 end caps.

- Item #: IC05 - 5' Cable Kit
- Item #: IC10 - 10' Cable Kit
- Item #: IC15 - 15' Cable Kit
- Item #: IC20 - 20' Cable Kit
- Item #: IC25 - 25' Cable Kit
- Item #: IC30 - 30' Cable Kit
- Item #: IC40 - 40' Cable Kit
- Item #: IC50 - 50' Cable Kit
- Item #: IC60 - 60' Cable Kit
- Item #: IC70 - 70' Cable Kit



THREADED STUD WITH CAP, NUT AND WASHER



PULL-LOCK™ LAG

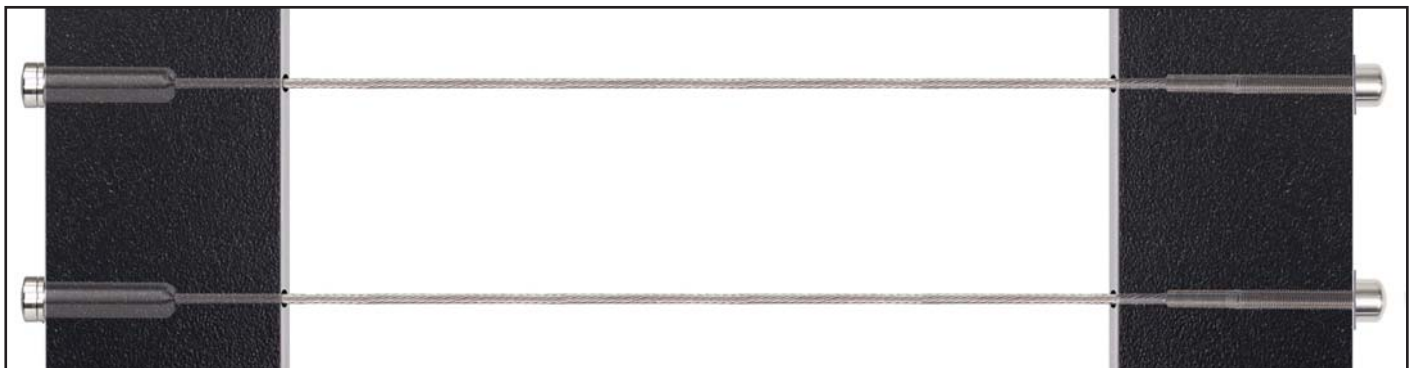

ACTUAL FREIGHT CHARGES WILL BE APPLIED TO RAILFX® ORDERS

3" RailFX® Oasis Aluminum Post - Cable



Available in:

Textured
Black

Oasis End Post - Pre-Drilled

Sold in any quantity.

3" Square surface mount post with pre-drilled 29/64" holes on the outside and 3/16" holes on the inside. Pre-drilled at 3-1/8" on center spacing. 10 holes for 36" rail, 12 holes for 42" rail. Pre-drilled for level brackets. Includes post cap and 1 piece skirt. 4-1/2" base plate has 3/8" holes spaced 3-3/4" on center for fasteners. Post skirt measures 5" wide.

36" Rail Height (3" x 38")

Item #: ORFX338CEPOSTTB

42" Rail Height (3" x 44")

Item #: ORFX344CEPOSTTB

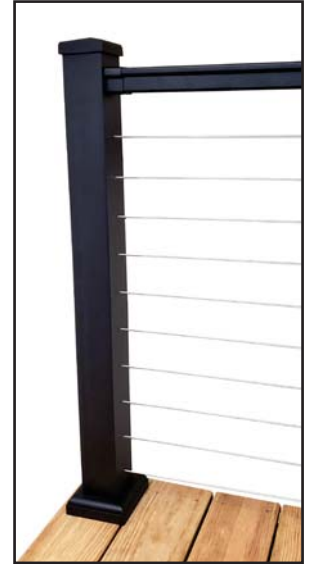

Available in:

Textured
Black

Oasis Intermediate Post - Pre-Drilled

Sold in any quantity.

3" Square surface mount post with pre-drilled 3/16" holes. Pre-drilled at 3-1/8" on center spacing. 10 holes for 36" rail, 12 holes for 42" rail. Pre-drilled for level brackets. Includes post cap and 1 piece skirt. 4-1/2" base plate has 3/8" holes spaced 3-3/4" on center for fasteners. Post skirt measures 5" wide.

36" Rail Height (3" x 38")

Item #: ORFX338CIPOSTTB

42" Rail Height (3" x 44")

Item #: ORFX344CIPOSTTB

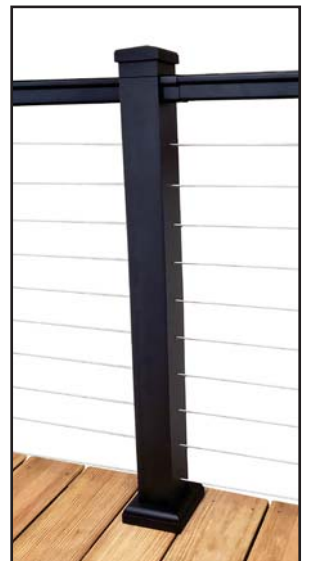

ACTUAL FREIGHT CHARGES WILL BE APPLIED TO RAILFX® ORDERS

3" RailFX® Oasis Aluminum Post - Cable



Available in:
Textured
Black

Oasis Corner Post - Pre-Drilled

Sold in any quantity.

3" Square surface mount post with pre-drilled 1/4" holes. Pre-drilled at 3-1/8" on center spacing. 10 holes for 36" rail, 12 holes for 42" rail. Pre-drilled for level brackets. Includes post cap, 1 piece skirt and internal corner rod. 4-1/2" base plate has 3/8" holes spaced 3-3/4" on center for fasteners. Post skirt measures 5" wide.

36" Rail Height (3" x 38")

Item #: ORFX338CCPOSTTB

42" Rail Height (3" x 44")

Item #: ORFX344CCPOSTTB

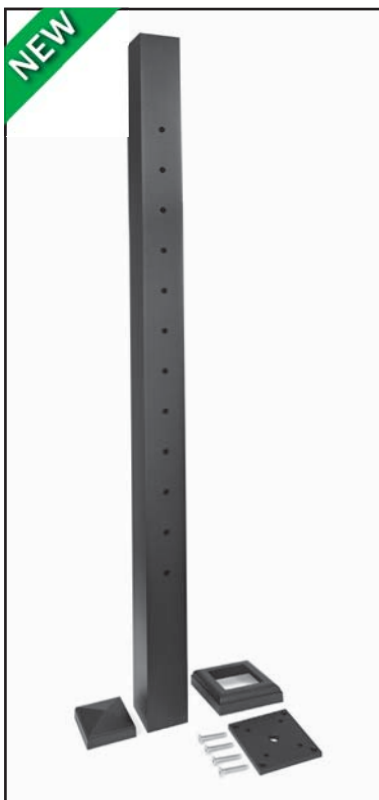
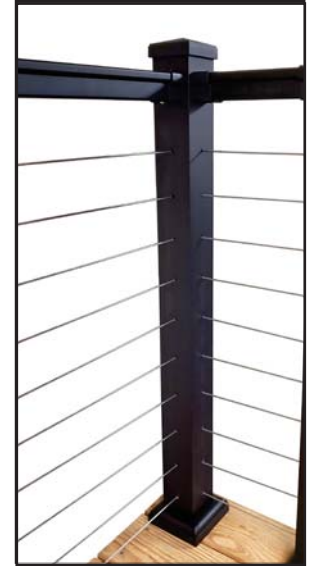

Available in:
Textured
Black

Oasis Stair End Post - Pre-Drilled

Sold in any quantity.

3" Square surface mount post with pre-drilled 29/64" holes on the outside and 3/16" holes on the inside. Pre-drilled at 3-1/8" on center spacing. 12 holes for 36" or 42" rail. Includes post cap, 1 piece skirt & baseplate with hardware. Base plate needs to be attached during installation. 4-1/2" base plate has 3/8" holes spaced 3-3/4" on center for fasteners. Post skirt measures 5" wide.

36" / 42" Rail Height (3" x 53")

Item #: ORFX353CSEPOSTTB

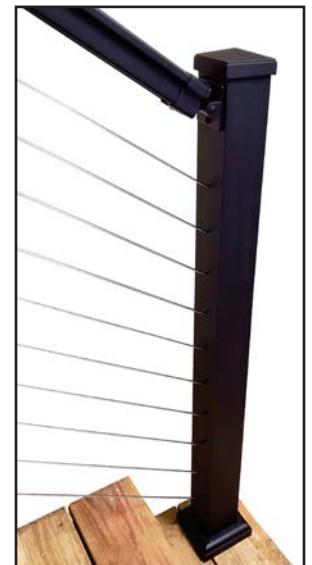

ACTUAL FREIGHT CHARGES WILL BE APPLIED TO RAILFX® ORDERS

3" RailFX® Oasis Aluminum Post - Cable



Available in:

 Textured
 Black

Oasis Stair Intermediate Post - Pre-Drilled

Sold in any quantity.

3" Square surface mount post with pre-drilled 3/16" slotted holes to accommodate 30° - 40° stair angles. Pre-drilled at 3-1/8" on center spacing. 12 holes for 36" or 42" rail. Includes post cap, 1 piece skirt & baseplate with hardware. Base plate needs to be attached during installation. 4-1/2" base plate has 3/8" holes spaced 3-3/4" on center for fasteners. Post skirt measures 5" wide.

36" / 42" Rail Height (3" x 53")

Item #: ORFX353CSIPOSTTB



Available in:

 Textured
 Black

DekPro™ EFFEX 3" Post Cap - Upgrade

Sold in any quantity.

Optional DekPro aluminum post cap with textured finish. Available in pyramid or flat top styles with both non-lighted and lighted options. LED lights features Quick Connect wiring system for easy installation.

Item # DPPC3FABT - Flat Top
 Item # DPPC3PABT - Pyramid



Available in:

 Textured
 Black

DekPro™ EFFEX 3" Lighted Post Caps

Sold in any quantity.

Optional DekPro aluminum post cap with textured finish. Available in pyramid or flat top styles with both non-lighted and lighted options. LED lights features Quick Connect wiring system for easy installation.

Item # DPPC3FDLABT - Flat Top Down Light
 Item # DPPC3PDLABT - Pyramid Down Light

Item # DPPC3FBLABT - Flat Top Glow Ring
 Item # DPPC3PBLABT - Pyramid Glow Ring



DekPro Quick Connect System



ACTUAL FREIGHT CHARGES WILL BE APPLIED TO RAILFX® ORDERS

Oasis Railing Top Rail Kits - Cable



Available in:
Textured
Black

8' Top Rail Kit - Level

Sold in Kits.

1 - 95" top rail, 2 top rail brackets, 1 cable brace with connectors.
Used for level rail to post attachment. Includes screws.

Item # ORFXCRK96-TXBL

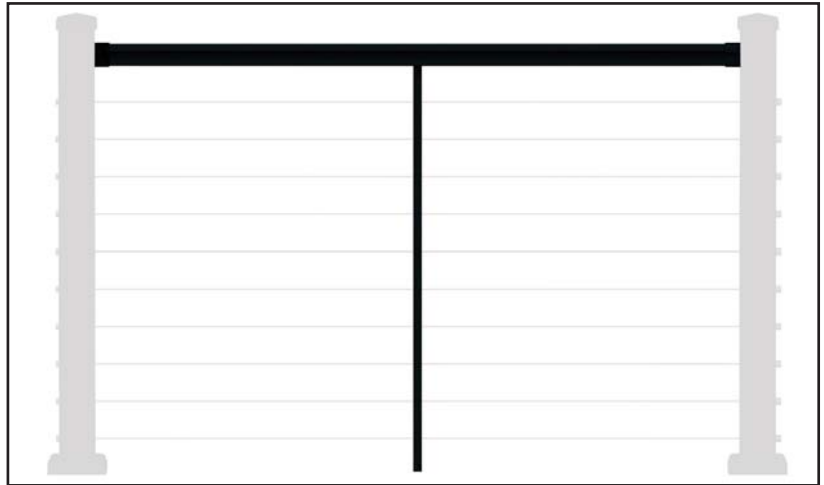

Available in:
Textured
Black

8' Top Rail Kit - Stair

Sold in kits.

1 - 95" top rail, 2 stair top rail brackets, 1 cable brace with connectors.
Used for stair rail to post attachment. Includes screws.

Item # ORFXCRSK96-TXBL

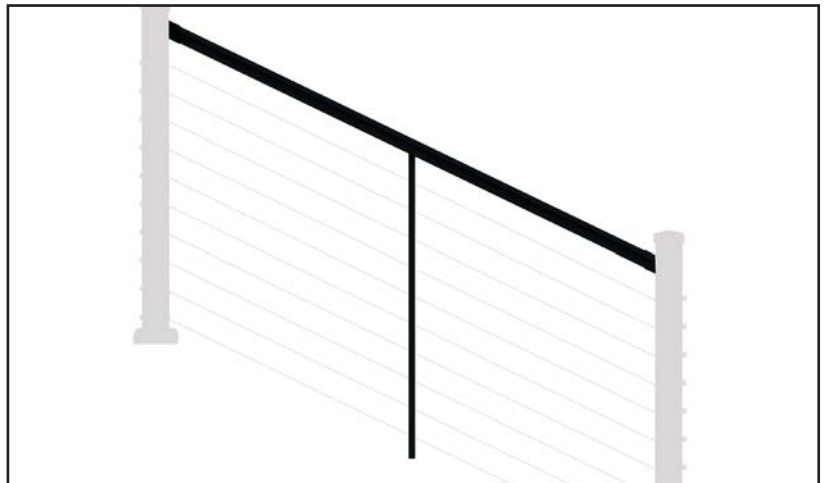

ACTUAL FREIGHT CHARGES WILL BE APPLIED TO RAILFX® ORDERS

Oasis Railing Bracket Kits - Cable



Available in:
Textured
Black

Level Rail Bracket Cut Kit

Sold in Pairs.

2 top rail brackets. Used when splitting level top rail kits. Includes screws.

Item # ORFXLBKT-TXBL



Available in:
Textured
Black

Stair Rail Bracket Cut Kit

Sold in Pairs.

2 top rail brackets with Stair adapter. Used when splitting stair top rail kits. Adjustable up to a 56 degree angle. Includes screws.

Item # ORFXSACRBKTKITB



Available in:
Textured
Black

Multi-Angle Adaptor Bracket

Sold in any quantity.

1 top rail multi-angle bracket adapter. Used for side to side angle rail to post attachment. **Requires a level bracket either from the rail kit or cut kit.** Adjustable up to a 49 degree angle. Includes screws.

Item # ORFXLACRBKT-TXBL



Available in:
Textured
Black

Oasis Touch-Up Paint

Sold in any quantity.

Sold in .6 oz. bottle to touch up rails. Brush on application.

Item # OPFXTUPTXBL

ACTUAL FREIGHT CHARGES WILL BE APPLIED TO RAILFX[®] ORDERS

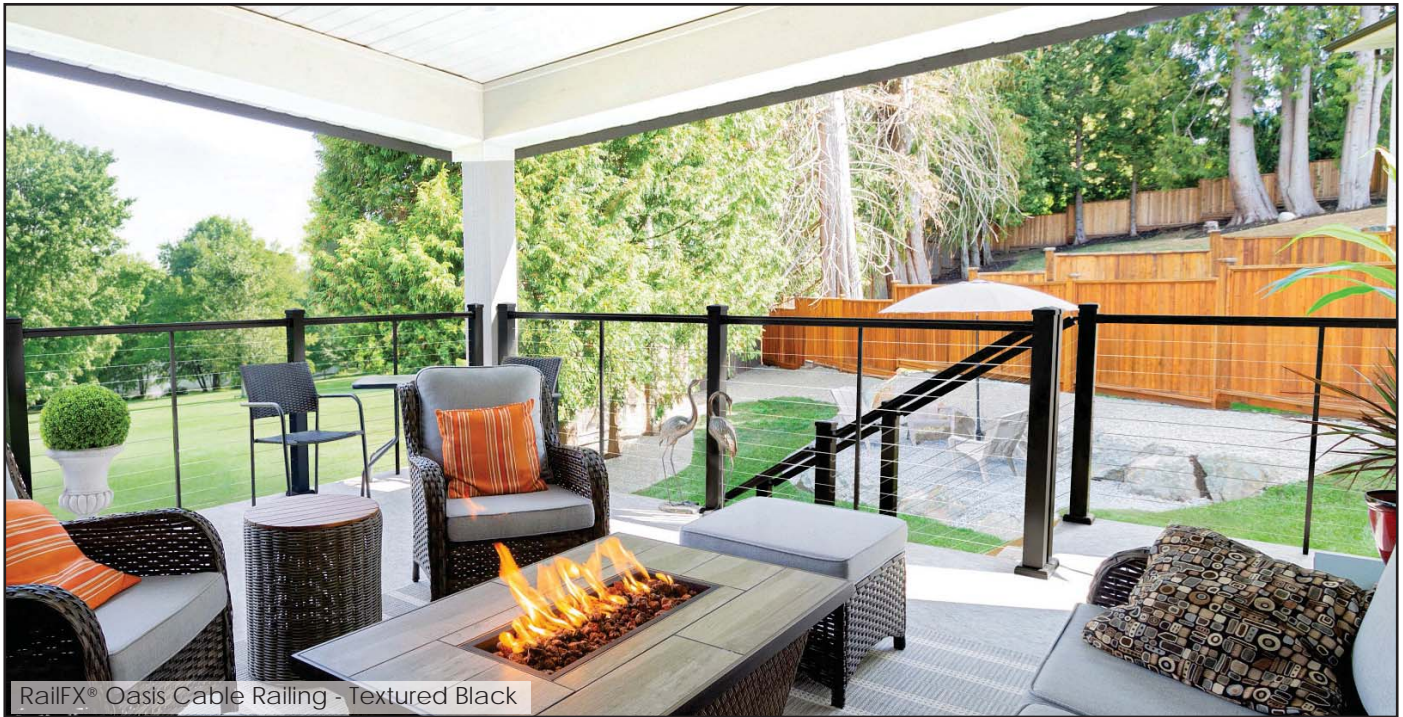

Oasis[™] Aluminum Rail & Cable System ■ RailFX[®]

RailFX® Oasis™ Picket Rail Overview



RailFX® Oasis™ Aluminum Picket Rail

RailFX® Oasis™ Picket railing system can be used with the Oasis Cable railing to value engineer the project. Cable can be ran on the "View" sides, while picket railing can be used on more discreet sides and stairs. Using picket rail in place of cable can reduce the overall cost of the project, while still allowing cable to be used on the views that matter most. See diagram below for reference.

RailFX® Oasis™ Picket is an aluminum rail with finely textured black powder coat finish. RailFX® Oasis™ brings simplicity and style together, allowing you to effortlessly achieve the perfect outdoor sanctuary. Made of extruded aluminum that will never rust, it is built to withstand the test of time with minimal maintenance.

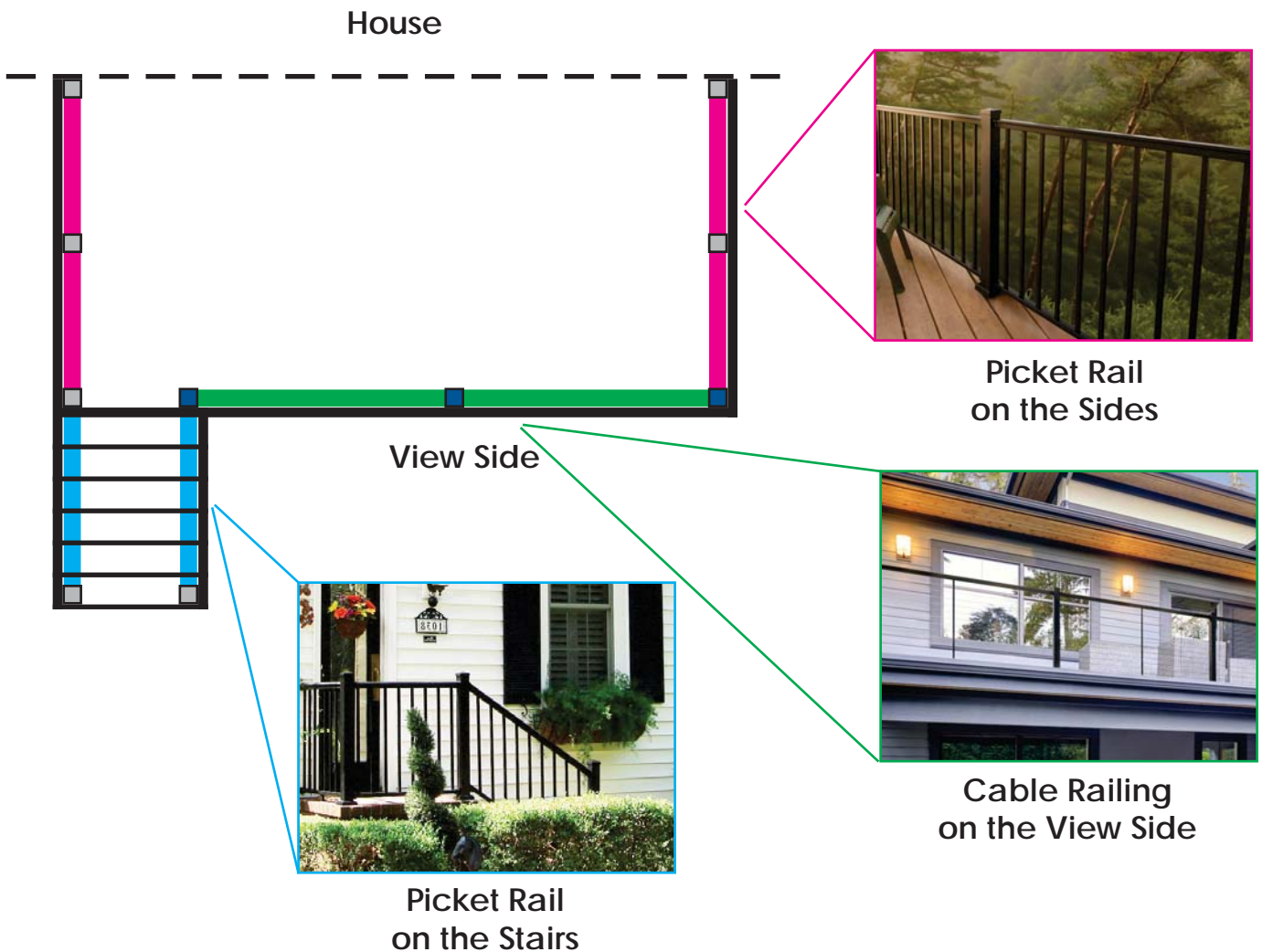

ACTUAL FREIGHT CHARGES WILL BE APPLIED TO RAILFX® ORDERS



RailFX® Oasis Level Rail - Textured Black

RailFX® Oasis Aluminum Railing Kits - LEVEL



Available in:
Textured Black

Oasis Aluminum Railing Kit - LEVEL

Sold in any quantity.

Textured aluminum level railing comes complete with top and bottom lineals (pre-slotted for balusters), 3/4" square balusters, brackets and rail support. 33" balusters used for 36" rail, 39" balusters used for 42" rail.

6' Level Rail Kits - 71-1/2"

36" Rail Height (34" x 71-1/2")

42" Rail Height (40" x 71-1/2")

Item # OPFXLRK636KDTXBL

Item # OPFXLRK642KDTXBL

8' Level Rail Kits - 95"

36" Rail Height (34" x 95")

42" Rail Height (40" x 95")

Item # OPFXLRK836KDTXBL

Item # OPFXLRK842KDTXBL

RailFX® Oasis Aluminum Railing Kits - STAIR



Available in:
Textured Black

Oasis Aluminum Railing Kit - STAIR

Sold in any quantity.

Textured aluminum adjustable stair railing comes complete with top and bottom lineals (pre-slotted for balusters), 3/4" square balusters, brackets and rail support. 33" balusters used for 36" rail, 39" balusters used for 42" rail.

6' Stair Rail Kits - 71-1/2"

36" Rail Height (34" x 71-1/2")

42" Rail Height (40" x 71-1/2")

Item # OPFXSRK636KDTXBL

Item # OPFXSRK642KDTXBL

8' Stair Rail Kits - 95"

36" Rail Height (34" x 95")

42" Rail Height (40" x 95")

Item # OPFXSRK836KDTXBL

Item # OPFXSRK842KDTXBL

Oasis™ Aluminum Picket Rail System ■ RailFX®

ACTUAL FREIGHT CHARGES WILL BE APPLIED TO RAILFX® ORDERS

3" RailFX® Oasis Aluminum Post



Available in:
Textured
Black

3" Aluminum Post w/ Post Cap and Skirt

Sold in any quantity.

3" Aluminum post with 5" welded flange. Base plate is 3/8" thick with 3/8" holes spaced 4" on center for fasteners. Post skirt measures 5" wide. **Post cap and 1 piece skirt are included.**

3" x 40"

Item # OPFX338POSTTXBL - Black

3" x 44"

Item # OPFX344POSTTXBL - Black

3" x 54"

Item # OPFX354POSTTXBL - Black



Drilling Template

Drilling Template to align railing brackets to post.

Item # OPFXDT



Available in:
Textured
Black

DekPro™ EFFEX 3" Post Cap - Upgrade

Sold in any quantity.

Optional DekPro aluminum post cap with textured finish. Available in pyramid or flat top styles with both non-lighted and lighted options. LED lights features Quick Connect wiring system for easy installation.

Item # DPPC3FABT - Flat Top

Item # DPPC3PABT - Pyramid



Available in:
Textured
Black

DekPro™ EFFEX 3" Lighted Post Caps

Sold in any quantity.

Optional DekPro aluminum post cap with textured finish. Available in pyramid or flat top styles with both non-lighted and lighted options. LED lights features Quick Connect wiring system for easy installation.

Item # DPPC3FDLABT - Flat Top Down Light

Item # DPPC3PDLABT - Pyramid Down Light

Item # DPPC3FBLABT - Flat Top Glow Ring

Item # DPPC3PBLABT - Pyramid Glow Ring



DekPro Quick Connect System

ACTUAL FREIGHT CHARGES WILL BE APPLIED TO RAILFX® ORDERS

Oasis Railing Bracket Kits



Available in:
Textured
Black

Level Rail Bracket Cut Kit - Picket Rail

Sold in Kits.

2 top rail brackets, 2 bottom rail brackets and 1 support block kit. Used for level rail to post attachment. Includes screws.

Item # OPFXLBKTTXBL



Available in:
Textured
Black

Stair Rail Bracket Cut Kit - Picket Rail

Sold in Kits.

2 top rail brackets, 2 bottom rail brackets and 1 support block kit. Used for side to side angle rail to post attachment. Adjustable up to a 56 degree angle. Includes screws.

Item # OPFXASBKTTXBL



Available in:
Textured
Black

Multi-Angle Adaptor Bracket - Picket Rail

Sold in Pairs.

1 top and 1 bottom rail multi-angle bracket adapter. Used for side to side angle rail to post attachment. Adjustable up to a 49 degree angle. Includes screws.

Item # OPFXLABKTTXBL



Available in:
Textured
Black

Post Jig - Drilling Template - Picket Rail

Sold in Pairs.

Drilling Template to align railing brackets to post for picket rail.

Item # OPFXDT



Fortress® AL13 Home Vertical Cable Rail



Post to Post Railing System



Use the steps below for the following pages to complete your rail

STEP 1 Choose Panel
Vertical Cable Railing

STEP 3 Choose post
3" Surface Mount

STEP 2 Choose Brackets (4 Pack)

STEP 4 Select Top Rail (ATR)
Flat ATR or Drink Rail

Fortress® AL13 Home Vertical Cable Railing System

Fortress AL13 Home cable railing system features fully assembled aluminum rails with vertical cable infill.

Panels install easily with a simple bracket system.

Aluminum construction, powder coat finish and stainless steel cables create a virtually maintenance free system.

Rail panels can be used as a complete system or they can be installed between existing posts.

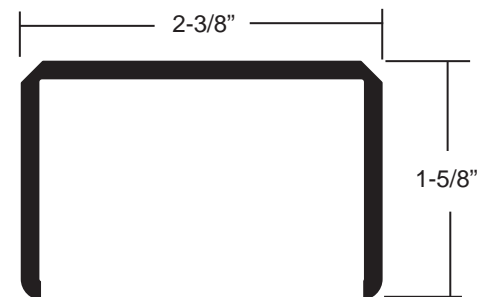

Top Rail Profile

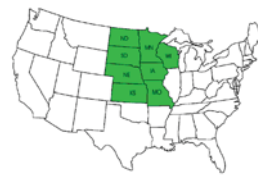

ACTUAL FREIGHT CHARGES APPLY TO FORTRESS® RAIL ORDERS



Fortress® Aluminum Vertical Cable Rail - Black Sand

Fortress® Al¹³ Home Vertical Cable Aluminum Panels

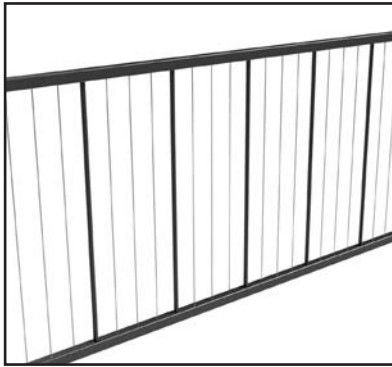

Top / bottom rail measure 1-1/4" x 1-1/4" and Infill is 1/8" cable for both level and stair panels.

6'rails include 4 ea. - 5/8" supports

8'rails include 6 ea. - 5/8" supports

Available in:

- Black Sand
- Matte White

6' - Vertical Cable Panel

Sold in any quantity

32.5" x 69.5" Vertical cable panel achieves a total railing height of 36".
40" x 69.5" Vertical cable panel achieves a total railing height of 42."

Requires the use of an Accent Top Rail (ATR) see next page.
Brackets sold separately, see page 167.

36" Rail Height (32.5" x 69.5" Panel)

42" Rail Height (40" x 69.5" Panel)

Item # **59732698** - Black Sand (Txt)
Item # **59732691** - Matte White (Txt)

Item # **59740698** - Black Sand (Txt)
Item # **59740691** - Matte White (Txt)

8' - Vertical Cable Panel

Sold in any quantity

32.5" x 93.5" Vertical cable panel achieves a total railing height of 36".
40" x 93.5" Vertical cable panel achieves a total railing height of 42."

Requires the use of an Accent Top Rail (ATR) see next page.
Brackets sold separately, see page 167.

36" Rail Height (32.5" x 93.5" Panel)

42" Rail Height (40" x 93.5" Panel)

Item # **59732938** - Black Sand (Txt)
Item # **59732931** - Matte White (Txt)

Item # **59740938** - Black Sand (Txt)
Item # **59740931** - Matte White (Txt)

Fortress® Al¹³ Home Adjustable Stair Vertical Cable Aluminum Panels

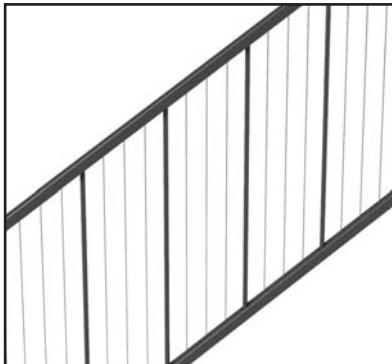

Available in:

- Black Sand
- Matte White

8' - Adjustable Stair Vertical Cable Panel

Sold in any quantity

Vertical Cable panel for stairs and ramps, achieves a total railing height of either 36" or 42". Panel adjustable from 5° - 45°.

Requires the use of an Accent Top Rail (ATR) see next page.
Brackets sold separately, see page 167.

36" Rail Height (32.5" x 93.5" Panel)

42" Rail Height (40" x 93.5" Panel)

Item # **59832738** - Black Sand (Txt)
Item # **59832731** - Matte White (Txt)

Item # **59840738** - Black Sand (Txt)
Item # **59840731** - Matte White (Txt)

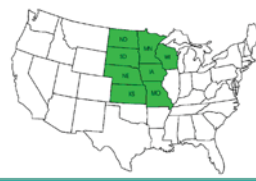

ACTUAL FREIGHT CHARGES APPLY TO FORTRESS® RAIL ORDERS

Fortress® Al¹³ Home Top Rail Covers



Available in:

Black Sand

Matte White

Flat Accent Top Rail (ATR)

Sold in any quantity.

Flat accent top rail snaps on top of rail panels to provide structural support and a finished design. Measures 100.875"L x 2-3/8"W x 1-5/8"H. Includes full length ATR spacer with hardware.

Item # 59511018 - Black Sand (Textured)

Item # 59511011 - Matte White (Textured)

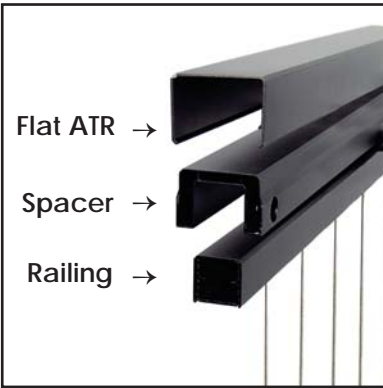

Available in:

Black Sand

Matte White

Cap Rail Clip for Drink Rail

Sold in packs of 4.

Cap rail clip used to attach a wood, vinyl or composite rail to the top of panel. Fits 1-1/4" square profile. Includes 4 cap rail clips, 2 bracket covers and hardware.

Item # 59500078 - Black Sand (Textured)

Item # 59500071 - Matte White (Textured)

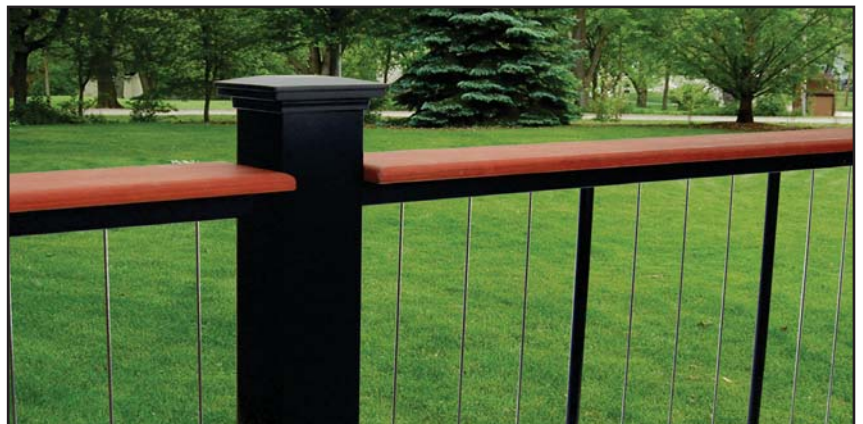
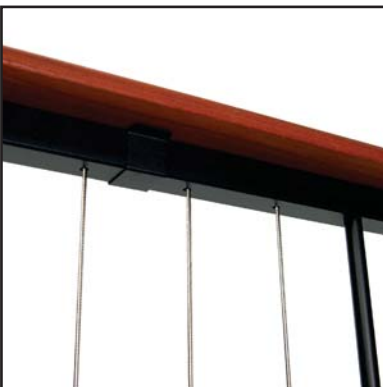

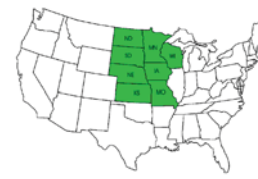

ACTUAL FREIGHT CHARGES APPLY TO FORTRESS® RAIL ORDERS

Fortress® AI¹³ Home Brackets



Available in:

- Black Sand
- Matte White

Level Bracket

Sold in packs of 4.

Top and bottom rails drop into brackets for level / straight applications. Includes snap cap cover for a finished look. Includes screws.

- Item # **59500218** - Black Sand (Textured)
- Item # **59500211** - Matte White (Textured)

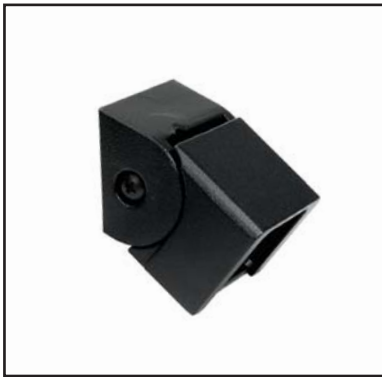

Available in:

- Black Sand
- Matte White

Stair Bracket

Sold in packs of 4.

Top and bottom rails drop into brackets for stair applications. Includes snap cap cover for a finished look. Adjustable for up to a 40 degree stair angle. Includes screws.

- Item # **59505078** - Black Sand (Textured)
- Item # **59505071** - Matte White (Textured)



Available in:

- Black Sand
- Matte White

Angle Bracket

Sold in packs of 4.

Top and bottom rails drop into brackets for level angle/miter applications. Includes snap cap cover for a finished look. Adjustable for up to a 45 degree horizontal angle. Includes screws.

- Item # **59500318** - Black Sand (Textured)
- Item # **59500311** - Matte White (Textured)



Black Sand

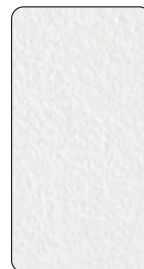

Matte White

Colors shown are an approximate representation only, please see actual product sample when selecting color

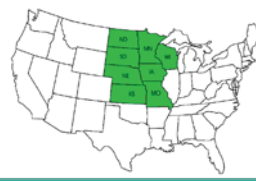

ACTUAL FREIGHT CHARGES APPLY TO FORTRESS® RAIL ORDERS

Fortress® AI¹³ Home Posts

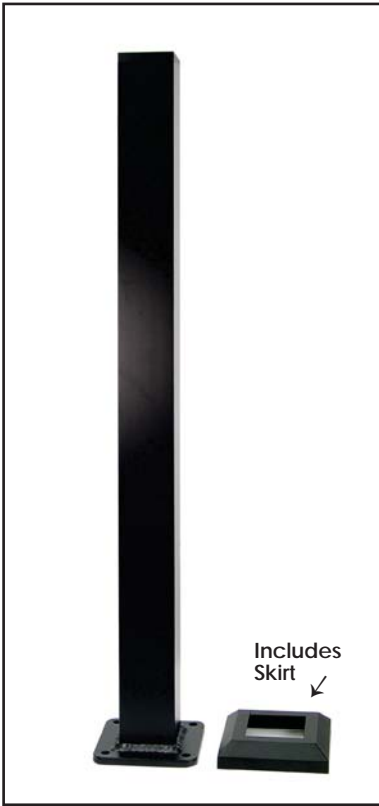

Available in:

- Black Sand
- Matte White

3" Post with 2 pc. Skirt

Sold in any quantity.

3" Aluminum posts with 5-1/2" flange and skirt. Flange holes are 1/2" for fasteners. Post skirt measures 5-3/4" wide. **Includes skirt for base.**

3" x 39.5" Post

- Item # **59339038** - Black Sand (Textured)
- Item # **59339031** - Matte White (Textured)

3" x 45.5" Post

- Item # **59345038** - Black Sand (Textured)
- Item # **59345031** - Matte White (Textured)



FortressAccents™ 3" Post Cap

Sold in any quantity.

Accents flat die cast aluminum post cap for 3" post.

- Item # **52500038** - Black Sand (Textured)
- Item # **52500032** - Matte White (Textured)



3" Post Skirt 2 pc. - Replacement

Sold in any quantity.

Post base cover included. Also sold separately. Measures 5-3/4" x 1-1/2" with 3-1/8" opening.

- Item # **51500038** - Black Sand (Textured)
- Item # **59505751** - Matte White (Textured)

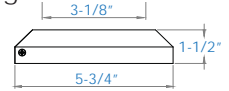

Available in:

- Black Sand
- Matte White

FortressAccents™ Post Cap with Optional Light Kit

Sold in any quantity.

Accents flat die cast aluminum post cap for 3" post. Light kit draws **2 watts**. Light color - 2600K. Includes wire nuts and 60" lead wire. **Must purchase LED cap light kit along with cap.**

3" Post Cap

- Item # **52500038** - Black Sand (Textured)
- Item # **52500032** - Matte White (Textured)

Light Kit

- Item # **52500000P** - LED Light Kit



FortressAccents Plug-N-Play



Item #: **52500000P**



Available in:

- Absolute Black

DekPro™ EFFEX 3" Post Caps

Sold in any quantity.

Optional DekPro aluminum post cap with textured finish. Available in pyramid or flat top styles with both non-lighted and lighted options. LED lights features Quick Connect wiring system for easy installation.

- Item # **DPPC3FABT** - Flat Top
- Item # **DPPC3PABT** - Pyramid
- Item # **DPPC3FDLABT** - Flat Top Down Light
- Item # **DPPC3PDLABT** - Pyramid Down Light
- Item # **DPPC3FBLABT** - Flat Top Glow Ring
- Item # **DPPC3PBLABT** - Pyramid Glow Ring



DekPro Quick Connect System



AI¹³ Home™ Aluminum Railing Systems ■ Fortress®



ACTUAL FREIGHT CHARGES APPLY TO FORTRESS® RAIL ORDERS

Fortress® Al¹³ Home Accessories



Available in:

- Black Sand
- Matte White

45 degree - Left Hand

Sold in any quantity

Left hand version - Top bracket cover for angle brackets at a 45 degree angle.

Flat 45 Left Hand Bracket

- Item # **59500518** - Black Sand (Textured)
- Item # **59500511** - Matte White (Textured)



Available in:

- Black Sand
- Matte White

45 degree - Right Hand

Sold in any quantity

Right hand version - Top bracket cover for angle brackets at a 45 degree angle.

Flat 45 Right Hand Bracket

- Item # **59500618** - Black Sand (Textured)
- Item # **59500611** - Matte White (Textured)

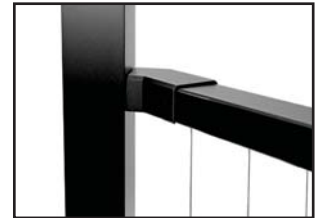

Available in:

- Black Sand
- Matte White

Touch-Up Paint

Sold in any quantity.

Available in two convenient sizes.

Spray Can (6oz)

- Item # **660378** - Black Sand (Textured)
- Item # **660374** - Matte White (Textured)

Paint Pen

- Item # **660368** - Black Sand (Textured)
- Item # **660364** - Matte White (Textured)



Sleeved Posts w/ Cable Overview

Framework For Aluminum Sleeved Wood Posts

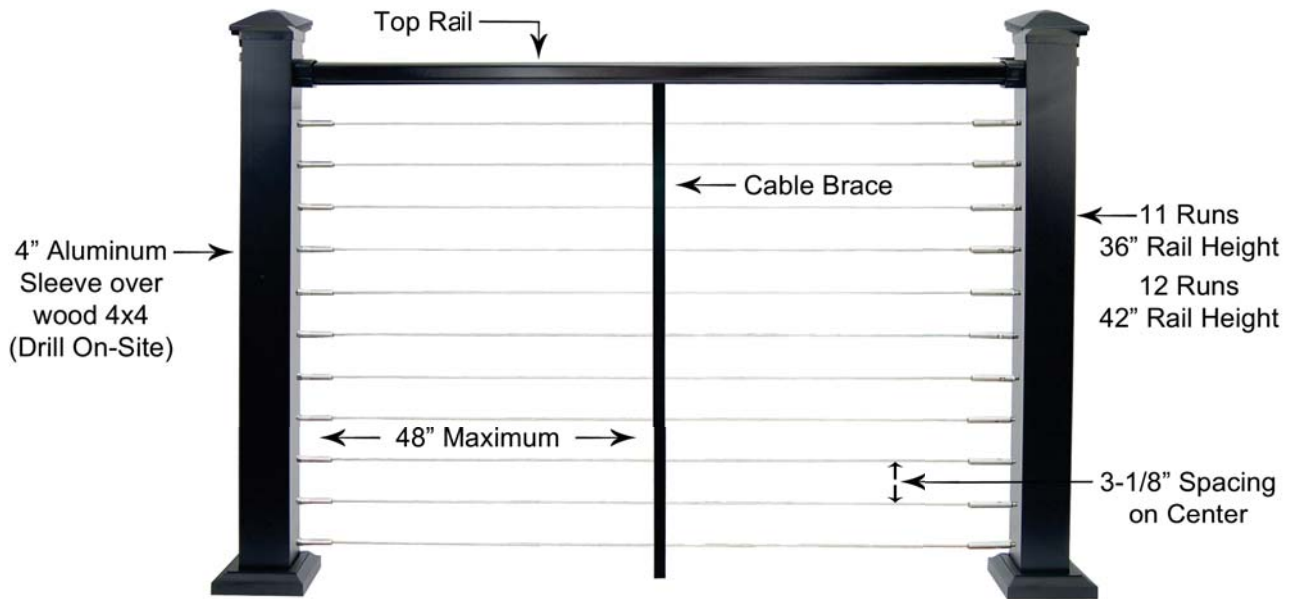

Guidelines for proper installation of the ADI™ cable railing system by RailFX®:

- Use 4" aluminum sleeve with a 4x4 wood post for structural support.
- Top rail is required to support posts. (Bottom rail is optional)
- Cables are to be spaced at 3-1/8" on center.
- Cable must be supported every 48" to keep the cable from deflecting over 4" to pass code.
- Cables are to be tensioned to 225 lbs of tension minimum.
- 36" Rail height typically uses 11 runs of cable, 42" rail height typically uses 12 runs of cable.
- Lag style cable fittings are required for cable used with sleeved posts.
- Cable kits must terminate at corner posts, or posts where the cable is at an angle.

For level runs using wood posts with aluminum sleeves.

(Outside diameter 4" or less)

RFXWLT - Tensioner Fitting
RFXWLN - Non-Tensioner Fitting
and Bulk Cable (100' or 500')

For stairs using wood posts with aluminum sleeves:

(Outside diameter 4" or less)

RFXWST - Stair Tensioner Fitting
RFXWSN - Stair Non-Tensioner Fitting
and Bulk Cable (100' or 500')

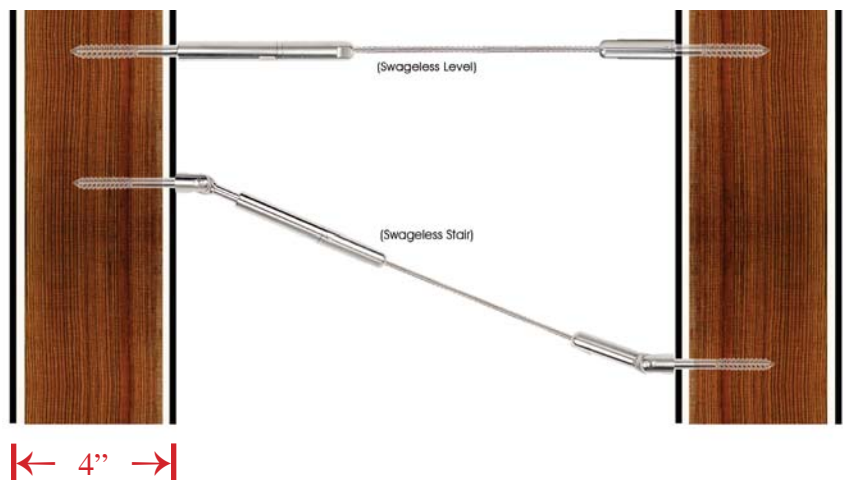

* If using sleeves over 4" in diameter - Use cable kits for composite sleeves. Reference pages 118 - 119

ACTUAL FREIGHT CHARGES APPLY TO DEKPROTM PRESTIGE RAIL ORDERS

Cable Railing w/ Aluminum Sleeves

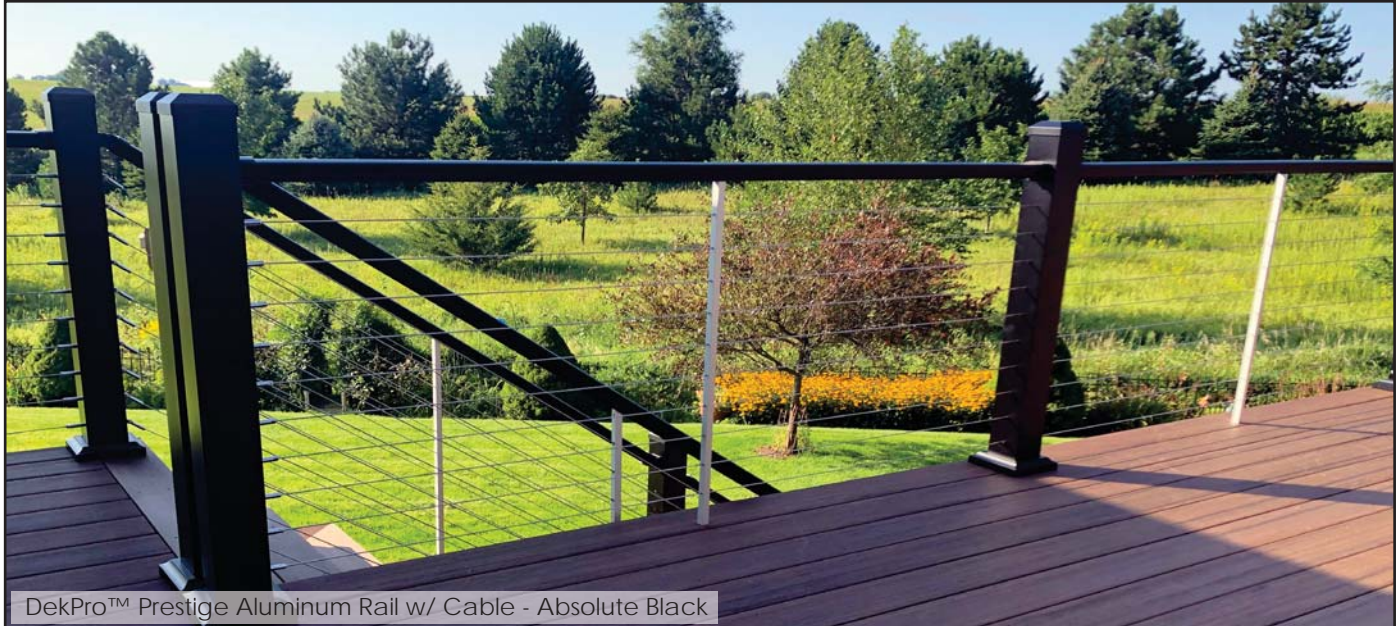

DekProTM Prestige Aluminum Rail w/ Cable - Absolute Black

Cable Railing for DekProTM Prestige 4" Sleeves

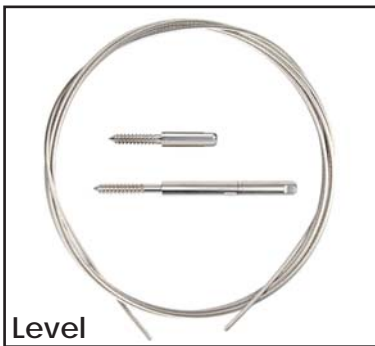

Level

FlexFXTM - Cable Fittings for Sleeves over Wood

Sold in any quantity.

Cable railing and fittings made from high quality 316 grade stainless steel. Designed to work for aluminum sleeved wood posts. Pre-drill using 7/32" drill bit.

Level Cable Fittings

- Item #: RFXWLN1/8 - 1/8" Non-Tensioner
- Item #: RFXWLN1/8-10 - 1/8" Non-Tensioner (10 Pack)



- Item #: RFXWLT1/8 - 1/8" Tensioner
- Item #: RFXWLT1/8-10 - 1/8" Tensioner (10 Pack)



Stair

Stair Cable Fittings

- Item #: RFXWSN1/8 - 1/8" Non-Tensioner
- Item #: RFXWSN1/8-10 - 1/8" Non-Tensioner (10 Pack)



- Item #: RFXWST1/8 - 1/8" Tensioner
- Item #: RFXWST1/8-10 - 1/8" Tensioner (10 Pack)



Bulk Cable Spools

- Item #: RFXCABLE100 - 100' Spool of 1/8" Cable
- Item #: RFXCABLE500 - 500' Spool of 1/8" Cable



ACTUAL FREIGHT CHARGES APPLY TO DEKPRO™ PRESTIGE RAIL ORDERS

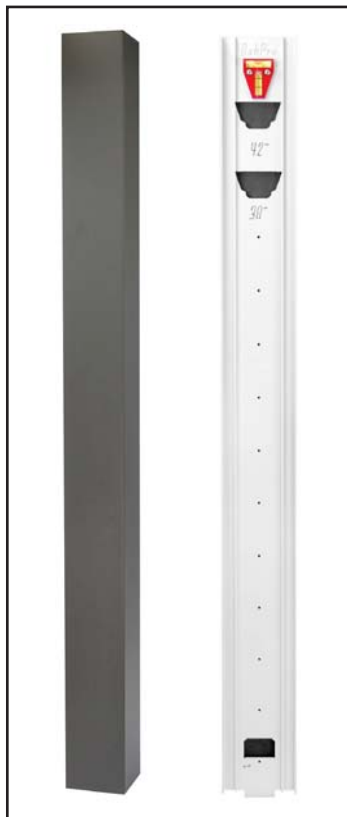

Available in:

- Absolute Black
- Cocoa Bronze
- Dream White
- Maple Cream

4" Aluminum Post Sleeve

Sold in any quantity.

4" textured sleeve designed to slide over a 3-5/8" wood post. Sleeves **MUST** be drilled to work with cable railing (11 runs typical for 36" rail).

4" x 40"

- Item # PR4040PSLEEVEABT - Black
- Item # PR4040PSLEEVECBT - Bronze
- Item # PR4040PSLEEVEDWT - White
- Item # PR4040PSLEEVE MCT - Maple

4" x 54"

- Item # PR4054PSLEEVEABT - Black
- Item # PR4054PSLEEVECBT - Bronze
- Item # PR4054PSLEEVEDWT - White
- Item # PR4054PSLEEVE MCT - Maple

4" x 44"

- Item # PR4044PSLEEVEABT - Black
- Item # PR4044PSLEEVECBT - Bronze
- Item # PR4044PSLEEVEDWT - White
- Item # PR4044PSLEEVE MCT - Maple

Quick Jig

Item # PRJIG3C - for 3" & 4" posts
(Includes pre-drilled holes for cable railing spacing)



4" Summit Pyramid Post Cap

Sold in any quantity.

- Item # DPPC4PABT - Absolute Black
- Item # DPPC4PCBT - Cocoa Bronze
- Item # DPPC4PDWT - Dream White
- Item # DPPC4PMCT - Maple Cream



4" Plateau Flat Top Post Cap

Sold in any quantity.

- Item # DPPC4FABT - Absolute Black
- Item # DPPC4FCBT - Cocoa Bronze
- Item # DPPC4FDWT - Dream White
- Item # DPPC4FMCT - Maple Cream



4" Post Skirt (2 Piece)

Sold in any quantity.

- Item # PR4SKIRTABT2PC - Absolute Black
- Item # PR4SKIRTCBT2PC - Cocoa Bronze
- Item # PR4SKIRTDWT2PC - Dream White
- Item # PR4SKIRTMCT2PC - Maple Cream

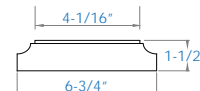

Available in:

- Absolute Black
- Cocoa Bronze
- Dream White
- Maple Cream

Aluminum Top Rail

Sold in any quantity.

Architectural style, textured powder coated aluminum top rail.

6' Top Rail (70")

- Item # PRTR70ABT - Absolute Black
- Item # PRTR70CBT - Cocoa Bronze
- Item # PRTR70DWT - Dream White
- Item # PRTR70MCT - Maple Cream

8' Top Rail (96-3/4")

- Item # PRTR96ABT - Absolute Black
- Item # PRTR96CBT - Cocoa Bronze
- Item # PRTR96DWT - Dream White
- Item # PRTR96MCT - Maple Cream



Top Rail Bracket

Each

For level top rail. Includes screws.

- Item # PRLBTABT - Absolute Black
- Item # PRLBTCBT - Cocoa Bronze
- Item # PRLBDWT - Dream White
- Item # PRLBTMCT - Maple Cream



Top Rail Stair Bracket

Each

For adjustable stair rail. Includes screws.

- Item # PRSBTABT - Absolute Black
- Item # PRSBTCBT - Cocoa Bronze
- Item # PRSBDWT - Dream White
- Item # PRSBTMCT - Maple Cream



Top Rail "Multi-Angle" Bracket

Each

For level rail side to side. Includes screws.

- Item # PRMATABT - Absolute Black
- Item # PRMATCBT - Cocoa Bronze
- Item # PRMATDWT - Dream White
- Item # PRMATMCT - Maple Cream

ACTUAL FREIGHT CHARGES APPLY TO DEKPRO™ PRESTIGE RAIL ORDERS

Cable Brace

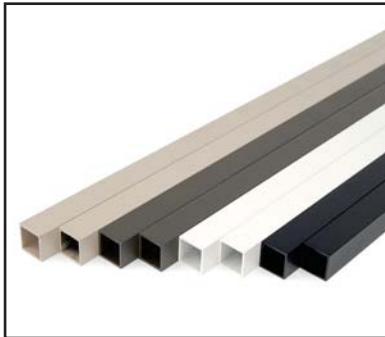

- Available in:
- Absolute Black
 - Cocoa Bronze
 - Dream White
 - Maple Cream

Square Cable Brace - Undrilled

Sold in any quantity.

3/4" Square undrilled balusters to be used as intermediate cable supports to match DekPro Prestige railing colors. Must be drilled on site. Requires connectors, see below.

38" Baluster (Level)

48" Baluster (Stair)

- Item # PR38SABT - Absolute Black
- Item # PR38SCBT - Cocoa Bronze
- Item # PR38SDWT - Dream White
- Item # PR38SMCT - Maple Cream

- Item # PR38SABT - Absolute Black
- Item # PR38SCBT - Cocoa Bronze
- Item # PR38SDWT - Dream White
- Item # PR38SMCT - Maple Cream



- Available in:
- Black

Baluster Connector - Level

Sold in poly bag of 20. 50/case

For 3/4" square balusters. Features a tall hidden connector that assures positive engagement for a secure connection. Includes 1-1/2" stainless steel screws.

Item # DP374 - Hidden Connector



- Available in:
- Black
 - Bronze
 - White

Square Baluster Connector - Stair

Sold in poly bag of 20. 35/case

For 3/4" square balusters being used on stairs with 33-37 degree angle. Features a tall connector that assures positive engagement for a secure connection. Includes 1-1/2" stainless steel screws.

- Item # DP377 - Black
- Item # DP377BZ - Bronze
- Item # DP377WH - White

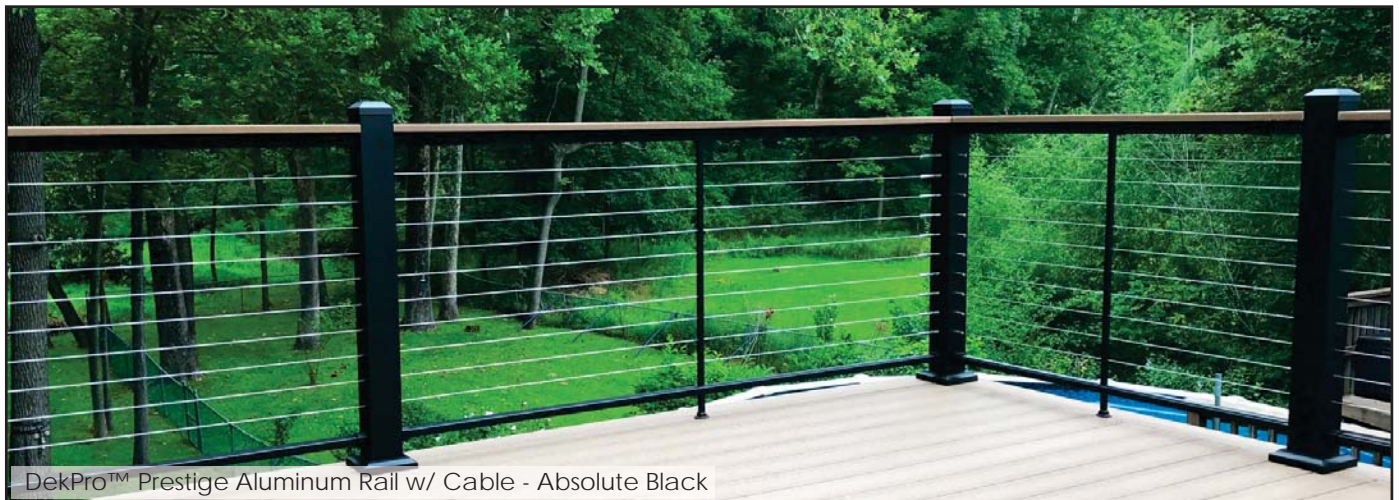

DekPro™ Prestige Aluminum Rail w/ Cable - Absolute Black

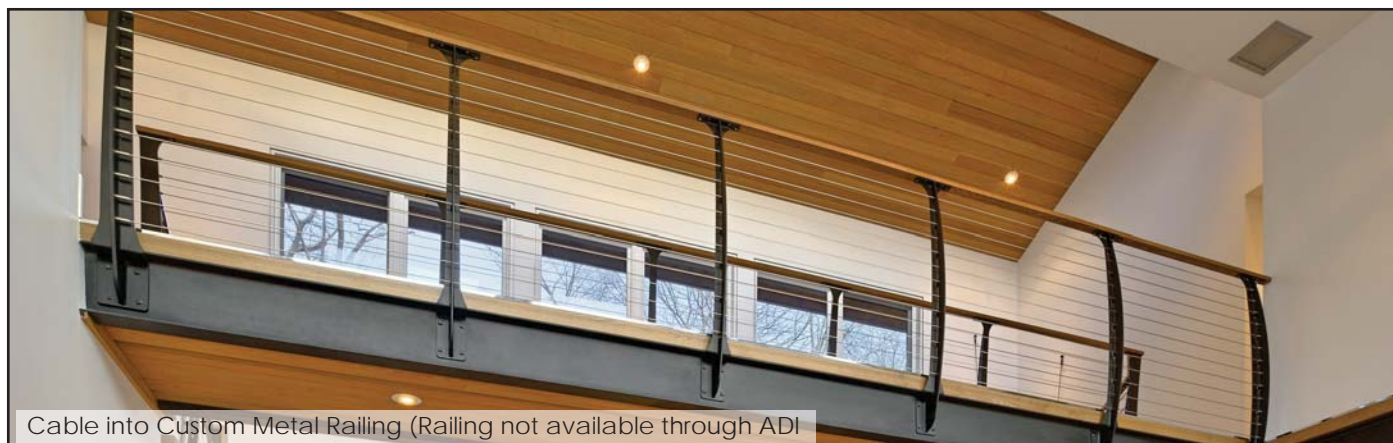

Cable into Custom Metal Railing (Railing not available through ADI)

Cable Railing for Metal - Level

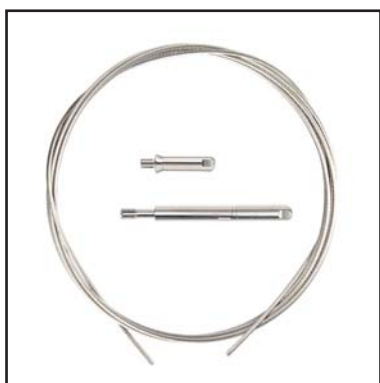

FOR METAL

*1/4" Post Wall
Thickness Required*

Drill & Tap to 5/16-24

FlexFXTM Cable Fittings for Metal (Post / Rails by Others)

Sold in any quantity.

Cable railing and fittings made from high quality 316 grade stainless steel. Designed to work for metal posts with 1/4" wall thickness. Drill and Tap to 5/16-24.

Level Fixed Fittings

- Item #: **RFXMLN1/8** - 1/8" Fitting
- Item #: **RFXMLN1/8-10** - 1/8" Fitting (10 Pack)

- Item #: **RFXMLN3/16** - 3/16" Fitting



NON-TENSIONER

Level Tensioning Fittings

- Item #: **RFXMLT1/8** - 1/8" Fitting
- Item #: **RFXMLT1/8-10** - 1/8" Fitting (10 Pack)

- Item #: **RFXMLT3/16** - 3/16" Fitting



TENSIONER

Bulk Cable

- Item #: **RFXCABLE100** - 100' Spool of 1/8" Cable
- Item #: **RFXCABLE500** - 500' Spool of 1/8" Cable

- Item #: **RFXCABLE100-6** - 100' Spool of 3/16" Cable
- Item #: **RFXCABLE500-6** - 500' Spool of 3/16" Cable



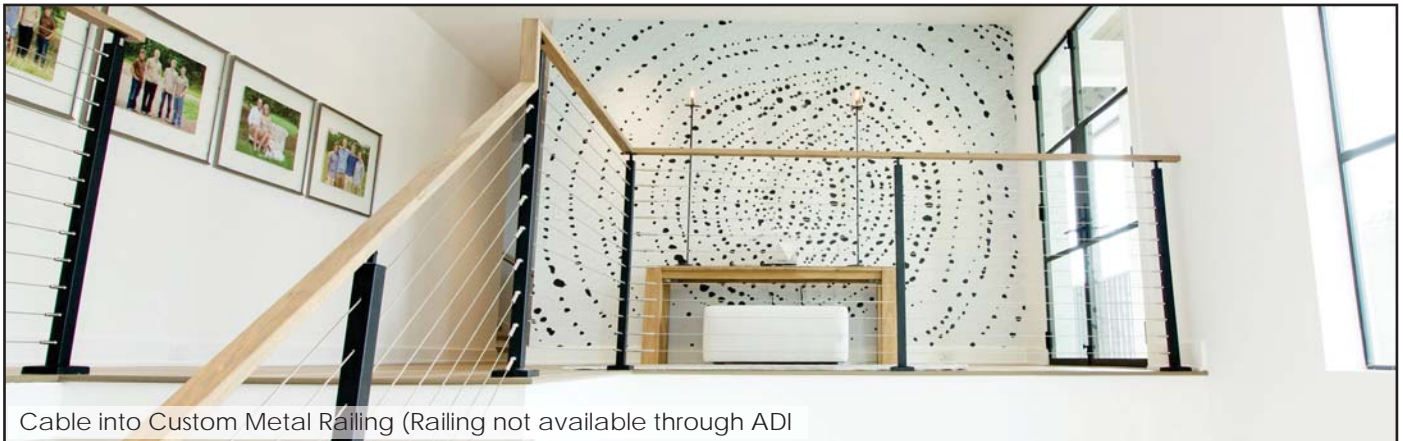

Cable into Custom Metal Railing (Railing not available through ADI)

Cable Railing for Metal - Stair



FOR METAL

1/4" post wall thickness required

Drill & tap to 5/16-24

FlexFXTM Cable Fittings for Metal (Post / Rails by Others)

Sold in any quantity.

Cable railing and fittings made from high quality 316 grade stainless steel. Designed to work for metal posts with 1/4" wall thickness. Drill and Tap to 5/16-24.

Stair Fixed Fittings

- Item #: **RFXMSN1/8** - 1/8" Fitting
- Item #: **RFXMSN1/8-10** - 1/8" Fitting (10 Pack)

- Item #: **RFXMSN3/16** - 3/16" Fitting



NON-TENSIONER

Stair Tensioning Fittings

- Item #: **RFXMST1/8** - 1/8" Fitting
- Item #: **RFXMST1/8-10** - 1/8" Fitting (10 Pack)

- Item #: **RFXMST3/16** - 3/16" Fitting



TENSIONER

Bulk Cable

- Item #: **RFXCABLE100** - 100' Spool of 1/8" Cable
- Item #: **RFXCABLE500** - 500' Spool of 1/8" Cable

- Item #: **RFXCABLE100-6** - 100' Spool of 3/16" Cable
- Item #: **RFXCABLE500-6** - 500' Spool of 3/16" Cable

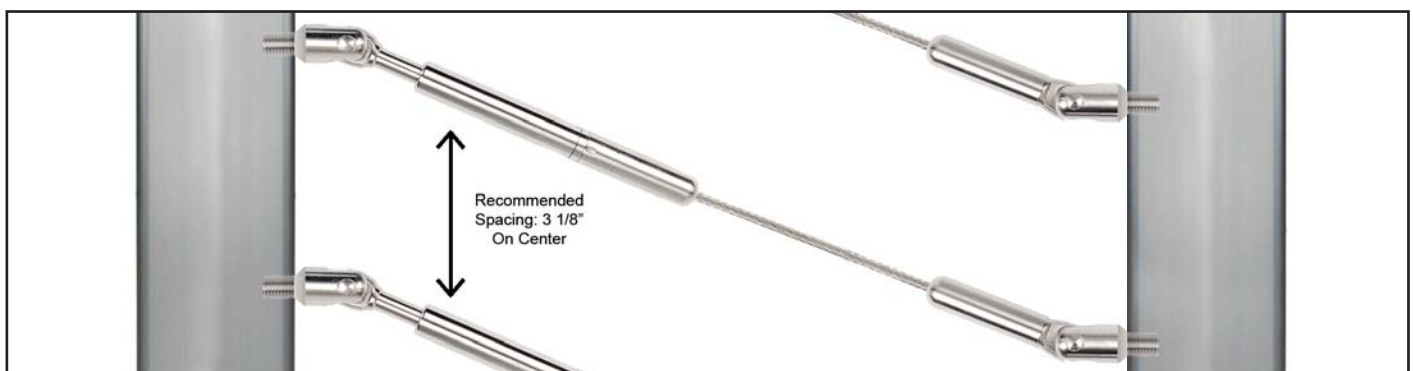

Cable Railing Kits for Metal Posts

Cable railing kit, made from 1/8" high quality 316 grade stainless steel includes 1 strand of cable w/swage, applicable washers, Invisiware[®] receiver, Pull-Lock[™] end fitting and end cap. Minimum of 3" clearance between end post and structure is required. 29/64" hole diameter required for end posts to accommodate fittings.

212 Series Cable for 1-1/2" Metal Posts

Cable railing kit consists of 1-1/2" Invisiware receiver, 1-1/2" pull-lock fitting, delrin washers and 1 strand of cable.

- Item #: **21205** - 5' Cable Kit
- Item #: **21210** - 10' Cable Kit
- Item #: **21215** - 15' Cable Kit
- Item #: **21220** - 20' Cable Kit
- Item #: **21225** - 25' Cable Kit



232 Series Cable for 2" Metal Posts

Cable railing kit consists of 2" Invisiware receiver, 2" pull-lock fitting, delrin washers and 1 strand of cable.

- Item #: **23205** - 5' Cable Kit
- Item #: **23210** - 10' Cable Kit
- Item #: **23215** - 15' Cable Kit
- Item #: **23220** - 20' Cable Kit
- Item #: **23225** - 25' Cable Kit



252 Series Cable for 3" Metal Posts

Cable railing kit consists of 3" Invisiware receiver, 3" pull-lock fitting, delrin washers and 1 strand of cable.

- Item #: **25205** - 5' Cable Kit
- Item #: **25210** - 10' Cable Kit
- Item #: **25215** - 15' Cable Kit
- Item #: **25220** - 20' Cable Kit
- Item #: **25225** - 25' Cable Kit



* PLEASE ENSURE THAT METAL POSTS BEING USED ARE RATED FOR CABLE *

RED item numbers denote **NON STOCK** special order. Please allow for 2 - 3 week lead time.

Cable Railing Tools



Cable Cutters

Sold in any quantity.

Cable cutter designed for clean, burr free cutting of 1/8" stainless steel cable. Required for use with Push-lockTM and Pull-lockTM fittings.

Item #: RFXC7HIT - for 1/8" Cable
Item #: RFXC9 - for 3/16" Cable



Cable Gripping Pliers

Sold in any quantity.

Used to securely grip cable to avoid winding during installation which eliminates the most common issue of cables losing tension. Cable gripping pliers are recommended for professional installers.

Item #: RFXPLIERS



Push Lock Release Key (1/8" Cable Only)

Sold in any quantity.

Release key allows the release of an untensioned cable from Pull-LockTM and Push-LockTM fittings. Also used to release fittings to aid installation.

Item #: RFXPLKEY/R

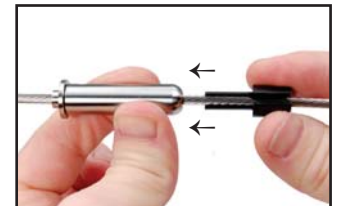

EZ-Clean Metal Cleaner / Protectant

Sold in any quantity.

Cleaner / Protector dissolves minor corrosion and leaves a protective coating that lasts for months. Includes 8 oz. rust and stain remover and 4 oz. bottle of protectant.

Item #: RFXEZCLEAN

ADITM