

# POST CAPS



**Wood Post Caps**

pg 136 - 139

**Wood Post Skirts**

pg 138

**Aluminum Post Caps**

pg 139 - 150



### Yellowstone - Solid Wood/Miterless

Sold in any quantity.

Yellowstone miterless pyramid: 3-5/8" or 5-5/8" post cap manufactured from solid piece of lumber.

Item #: AC-32G-2CA - Cedar - 3-5/8" X 3-5/8"  
 AC-32G-2PA - Treated - 3-5/8" X 3-5/8"  
 AC-32G-2IA - IPE - 3-5/8" X 3-5/8"

Item #: AC-52G-2CA - Cedar - 5-5/8" X 5-5/8"  
 AC-52G-2PA - Treated - 5-5/8" X 5-5/8"  
 AC-52G-2IA - IPE - 5-5/8" X 5-5/8"

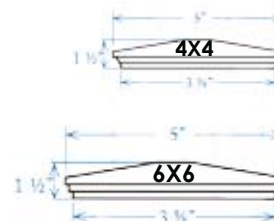

### Amherst - Solid Wood/Miterless

Sold in any quantity.

Amherst miterless pyramid: 3-5/8" or 5-5/8" post cap manufactured from solid piece of lumber.

Item #: AC-32H-2CA - Cedar - 3-5/8" X 3-5/8"  
 AC-32H-2PA - Treated - 3-5/8" X 3-5/8"  
 AC-32H-2IA - IPE - 3-5/8" X 3-5/8"

Item #: AC-52H-2CA - Cedar - 5-5/8" X 5-5/8"  
 AC-52H-2PA - Treated - 5-5/8" X 5-5/8"  
 AC-52H-2IA - IPE - 5-5/8" X 5-5/8"

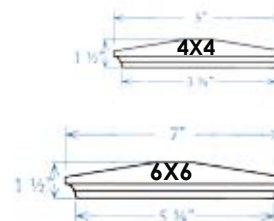

### Woodway™ Wood Pyramid Top

Sold in any quantity.

Wood pyramid top with wood skirt.

Item #: WW1383 - Cedar - 3-5/8" X 3-5/8"  
 Item #: WW2033 - Treated - 3-5/8" X 3-5/8"

Item #: WW1170 - Cedar - 4-1/8" X 4-1/8"

Item #: WW1641 - Cedar - 5-5/8" X 5-5/8"  
 Item #: WW3167 - Treated - 5-5/8" X 5-5/8"

Item #: WW1179 - Cedar - 6-1/8" X 6-1/8"

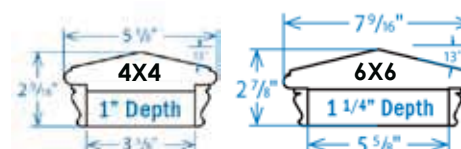

### Woodway™ Hatteras Pyramid Top

Sold in any quantity.

Wood pyramid top with wood skirt.

Item #: WW1389 - Cedar - 3-5/8" X 3-5/8"  
 Item #: WW2038 - Treated - 3-5/8" X 3-5/8"

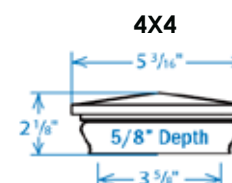



### Woodway™ Wood Flat Top

Sold in any quantity.

Wood flat top with wood skirt.

- Item #: WW1382 - Cedar - 3-5/8" X 3-5/8"
- Item #: WW2032 - Treated - 3-5/8" X 3-5/8"
- Item #: WW1642 - Cedar - 5-5/8" X 5-5/8"
- Item #: WW3166 - Treated - 5-5/8" X 5-5/8"

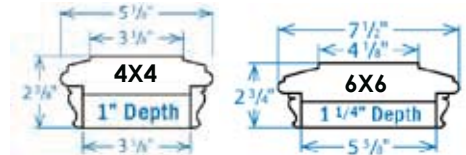

### Woodway™ Hatteras Flat Top

Sold in any quantity.

Flat top with wood skirt.

- Item #: WW1391 - Cedar - 3-5/8" X 3-5/8"
- Item #: WW2037 - Treated - 3-5/8" X 3-5/8"

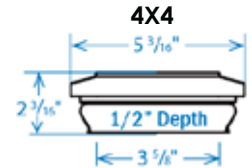

### Woodway™ Flat Top - No Skirt

Sold in any quantity.

Wood flat top with no skirt.

- Item #: WW1393 - Cedar - 3-5/8" X 3-5/8"
- Item #: WW1067 - Treated - 3-5/8" X 3-5/8"

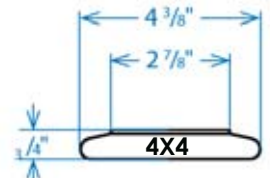

### Woodway™ Newport - Wood Ball Top

Sold in any quantity.

Wood ball top with wood skirt.

- Item #: WW1392 - Cedar - 3-5/8" X 3-5/8"
- Item #: WW2036 - Treated - 3-5/8" X 3-5/8"
- Item #: WW1783 - Cedar - 5-5/8" X 5-5/8"

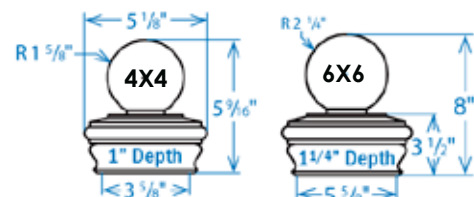



### Cedar Wood Skirt for 3 5/8" X 3 5/8" Post

Sold in any quantity.

Cedar wood skirt - 2 pieces - Cedar wood skirt that requires no cutting, just simply attach the last mitered piece. Fits over Titan<sup>TM</sup> 4x4 post anchor.

Item #: SKWOOD44 - Cedar skirt for 4x4



Cedar wood moulding - 36" cedar moulding designed to fit 4x4 and 6x6 Titan<sup>TM</sup> post anchors. Requires cutting, mitering and assembly.

Item #: SKWOODSTICK66 - 36" Cedar moulding for 4x4 or 6x6



### Woodway<sup>TM</sup> 2 Piece Cedar Post Skirt

Sold in any quantity.

Post skirt for wrapping base of post, can be attached after post is installed.

Item #: WW3326 - Cedar - 3-5/8" X 3-5/8"

Item #: WW3327 - Cedar - 5-5/8" X 5-5/8"



### Woodway<sup>TM</sup> Pyramid - Copper

Sold in any quantity.

Metal pyramid top with wood skirt.

Item #: WW1384 - Cedar - 3-5/8" X 3-5/8"

Item #: WW2039 - Treated - 3-5/8" X 3-5/8"

Item #: WW1669 - Cedar - 5-5/8" X 5-5/8"

Item #: WW3078 - Treated - 5-5/8" X 5-5/8"

Item #: WW1181 - Cedar - 6-1/16" X 6-1/16"

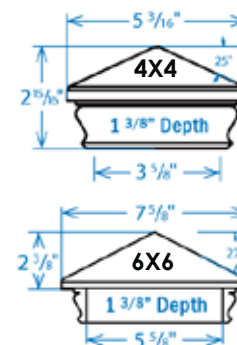

### Woodway<sup>TM</sup> Metal Pyramid Top 4x4 - Copper

Sold in any quantity.

Metal pyramid top with wood skirt.

Item #: WW1388 - Cedar - 3-5/8" X 3-5/8"

Item #: WW2035 - Treated - 3-5/8" X 3-5/8"

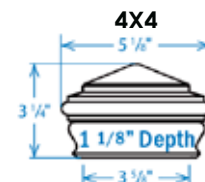



### Woodway™ Flat Top - Copper

Sold in any quantity.

Metal flat top with wood skirt.

- Item #: WW1387 - Cedar - 3-5/8" X 3-5/8"
- Item #: WW2034 - Treated - 3-5/8" X 3-5/8"
- Item #: WW3345 - Cedar - 5-5/8" X 5-5/8"

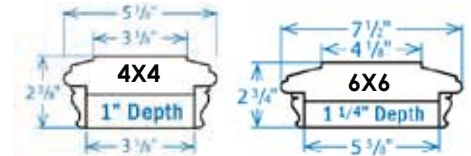

### Post Point - Copper

Sold in any quantity.

Copper pyramid.

- Item #: WW1845 - Copper - 3-5/8" X 3-5/8"
- Item #: CT6 - Copper - 5-5/8" X 5-5/8"

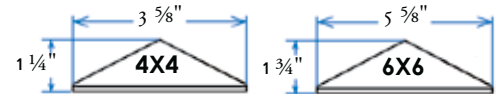

### Woodway™ Metal Pyramid w/ Wood Skirt - Black

Sold in any quantity.

Metal pyramid top with wood skirt.

- Item #: WW1250 - Cedar - 3-5/8" X 3-5/8"
- Item #: WW1280 - Treated - 3-5/8" X 3-5/8"
- Item #: WW1276 - Cedar - 5-5/8" X 5-5/8"
- Item #: WW1290 - Treated - 5-5/8" X 5-5/8"

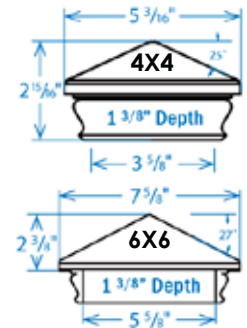

### Sirius Pyramid All Aluminum Post Cap - Black

Sold in any quantity.

Aluminum pyramid post cap with aluminum skirt. (Fasteners Included)

- Item #: PCA-5068 - 3-5/8" X 3-5/8"
- Item #: RLAC-6058 - 4-1/16" X 4-1/16"
- Item #: PCA-8068 - 5-9/16" X 5-9/16"



THIS CAP IS ALSO AVAILABLE WITH A LIGHT OPTION, PLEASE SEE THE LOW VOLTAGE LIGHTING SECTION FOR MORE INFORMATION  
THIS CAP MAY BE USED ON MORE POST SIZES BY CHANGING THE BASE, PLEASE SEE PAGE 151 FOR MORE OPTIONS

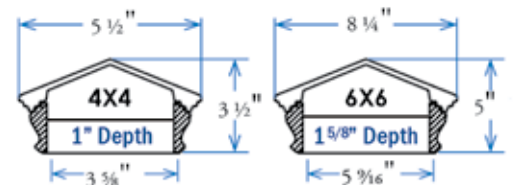



## Dekpro™ Pyramid Post Cap - Black

Sold in any quantity.

Powder coated aluminum pyramid post cap with skirt. 2 ea. screws included, some assembly required.

- Item #: DP35PB - 3-5/8" X 3-5/8"
- Item #: DP4PB - 4" X 4"
- Item #: DP43PB - 4-3/8" X 4-3/8"
- Item #: DP55PB - 5-5/8" X 5-5/8"
- Item #: DP6PB - 6-1/16" X 6-1/16"

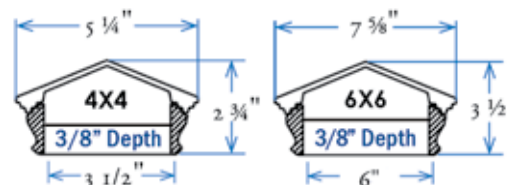

## Accents Textured Flat Aluminum Cap - Black Sand

Sold in any quantity.

Accents flat die cast aluminum post cap adapts to many different post sizes. (Optional LED light kit sold separately)

- Item #: 52500028 - 2" X 2"
  - Item #: 52500038 - 3" X 3"
  - Item #: 52500358 - 3-5/8" X 3-5/8"
  - Item #: 52500048 - 4" X 4"
  - Item #: 52500058 - 5" X 5" and \*4-1/2" X 4-1/2"
  - Item #: 52506008 - 6" X 6" and \*5-5/8" X 5-5/8"
- \*Adapter ring included for 4-1/2" version  
\*Adapter ring included for 5-5/8" version

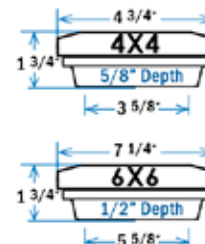

THIS CAP IS ALSO AVAILABLE WITH A LIGHT OPTION, PLEASE SEE THE LOW VOLTAGE LIGHTING SECTION FOR MORE INFORMATION



## Accents Textured Post Skirt - Black Sand

Sold in any quantity.

Two piece aluminum post base skirt to match Fortress™ Accents post caps. Comes pre-assembled in packaging, screws included.

- Item #: 52535018 - 3-5/8" Skirt
- Item #: 52504018 - 4" Skirt
- Item #: 52505018 - 5" Skirt (4-1/2" Adaptor included)
- Item #: 52506018 - 6" Skirt (5-5/8" Adaptor included)

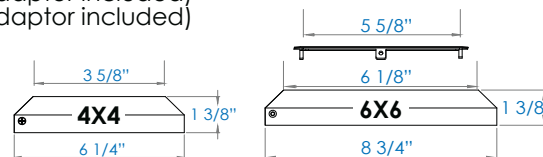

## Accents Flat Aluminum Cap - Gloss Black

Sold in any quantity.

Accents flat die cast aluminum post cap adapts to many different post sizes. (Optional LED light kit sold separately)

- Item #: 52500020 - 2" X 2"
  - Item #: 52500030 - 3" X 3"
  - Item #: 52500350 - 3-5/8" X 3-5/8"
  - Item #: 52500040 - 4" X 4"
  - Item #: 52500050 - 5" X 5" and \*4-1/2" X 4-1/2"
  - Item #: 52506000 - 6" X 6" and \*5-5/8" X 5-5/8"
- \*Adapter ring included for 4-1/2" version  
\*Adapter ring included for 5-5/8" version

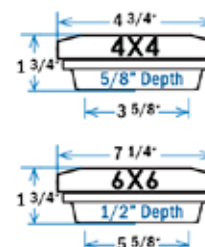

THIS CAP IS ALSO AVAILABLE WITH A LIGHT OPTION, PLEASE SEE THE LOW VOLTAGE LIGHTING SECTION FOR MORE INFORMATION



### Accents Post Skirt - Gloss Black

Sold in any quantity.

Two piece aluminum post base skirt to match Fortress™ Accents post caps. Comes pre-assembled in packaging, screws included.

- Item #: 52535010 - 3-5/8" Skirt
- Item #: 52504010 - 4" Skirt
- Item #: 52505010 - 5" Skirt (4-1/2" Adaptor included)
- Item #: 52506010 - 6" Skirt (5-5/8" Adaptor included)

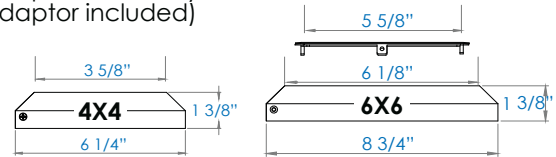

### Titan Flat Top All Aluminum Post Cap - Black

Sold in any quantity.

Aluminum flat top post cap with aluminum skirt. (Fasteners Included)

- Item #: PCA-5038 - 3-5/8" X 3-5/8"
- Item #: RLAC-6048 - 4-1/16" X 4-1/16"
- Item #: CLAC-6048 - 4-3/8" X 4-3/8"
- Item #: FLAC-6048 - 5-1/16" X 5-1/16"
- Item #: PCA-8038 - 5-9/16" X 5-9/16"

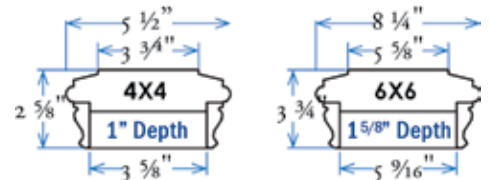

THIS CAP IS ALSO AVAILABLE WITH A LIGHT OPTION, PLEASE SEE THE LOW VOLTAGE LIGHTING SECTION FOR MORE INFORMATION  
THIS CAP MAY BE USED ON MORE POST SIZES BY CHANGING THE BASE, PLEASE SEE PAGE 151 FOR MORE OPTIONS



### Dekpro™ Flat Top Post Cap - Black

Sold in any quantity.

Powder coated aluminum flat top post cap with skirt. 2 ea. screws included, some assembly required.

- Item #: DP35FB - 3-5/8" X 3-5/8"
- Item #: DP4FB - 4" X 4"
- Item #: DP43FB - 4-3/8" X 4-3/8"
- Item #: DP55FB - 5-5/8" X 5-5/8"
- Item #: DP6FB - 6-1/16" X 6-1/16"

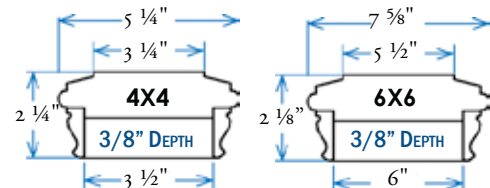

### Rondi Textured Unlit Post Cap - Antique Black

Sold in any quantity.

Antique textured black Rondi post cap made from high quality sand cast aluminum and is available in 6 different sizes to fit a wide array of wood and composite post sizes.

- Item #: PCLR05 - 3-5/8"
- Item #: PCR4105 - 4-1/8"
- Item #: PCR05 - 4-9/16"
- Item #: PCR5105 - 5-1/8"
- Item #: PCG05 - 5-5/8"
- Item #: PCBK05 - 6-1/16"

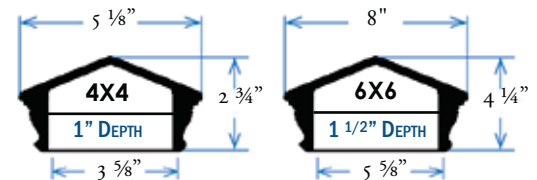

THIS CAP IS ALSO AVAILABLE WITH A LIGHT OPTION, PLEASE SEE THE LOW VOLTAGE LIGHTING SECTION FOR MORE INFORMATION



## Modular Aluminum Post Cap System

(Fits post sizes 3-5/8" 4", 4-3/8", 5-5/8", and 6")

Innovative modular post cap system by DekPro™ Manufacturing. Maximizes versatility by allowing you to pick your components to achieve the desired color combination and size.



Choose:



Or



Then



If Necessary



(OPTIONAL)

### Black Modular Pyramid Aluminum Post Cap

Sold in any quantity.

Item #: DPMCP35B - Pyramid portion for use with 3-5/8" X 3-5/8" base shown below.

Item #: DPMCP43B - Pyramid portion for use 4-3/8" X 4-3/8" base shown below.

Item #: DPMCP6B - Pyramid portion for use with 6" X 6" base shown below.

### Black Modular Flat Aluminum Post Cap

Sold in any quantity.

Item #: DPMCF35B - Flat top portion for use with 3-5/8" X 3-5/8" base shown below.

Item #: DPMCF43B - Flat top portion for use 4-3/8" X 4-3/8" base shown below.

Item #: DPMCF6B - Flat top portion for use with 6" X 6" base shown below.

### Black Base for Modular Post Cap

Sold in any quantity.

Item #: DPMB35B - Base portion for use with 3-5/8" X 3-5/8" tops shown above.

Item #: DPMB43B - Base portion for use with 4-3/8" X 4-3/8" tops shown above.

Item #: DPMB6B - Base portion for use with 6" X 6" tops shown above.

### Adapter Ring For More Post Cap Options

Sold in any quantity.

Item #: DPMA4B - Adaptor ring for use with 4-3/8" X 4-3/8" base shown above to adapt to a 4" post.

Item #: DPMA5B - Adaptor ring for use with 6" X 6" base shown above to adapt to a 5-5/8" X 5-5/8" post.

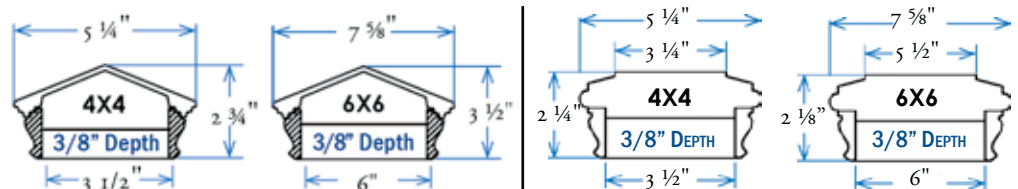





### Post Points - Black

Sold in any quantity.

Black aluminum post point.

Item #: DPPP35B - Black - 3-5/8" X 3-5/8"  
Item #: DPPP6B - Black - 5-5/8" X 5-5/8"

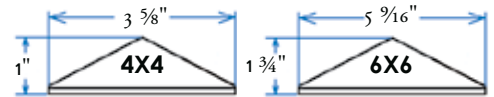

### Woodway™ Metal Pyramid w/ Wood Skirt - Bronze

Sold in any quantity.

Metal pyramid top with wood skirt.

Item #: WW1253 - Cedar - 3-5/8" X 3-5/8"  
Item #: WW1285 - Treated - 3-5/8" X 3-5/8"

Item #: WW1277 - Cedar - 5-5/8" X 5-5/8"  
Item #: WW1296 - Treated - 5-5/8" X 5-5/8"

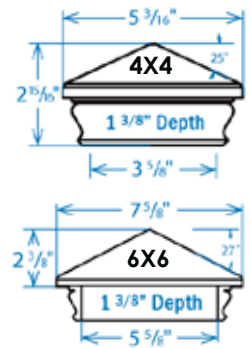

### Sirius Pyramid All Aluminum Post Cap - Bronze

Sold in any quantity.

Aluminum pyramid post cap with aluminum skirt. (Fasteners Included)

Item #: PCA-5065 - 3-5/8" X 3-5/8"  
Item #: PCA-8065 - 5-9/16" X 5-9/16"

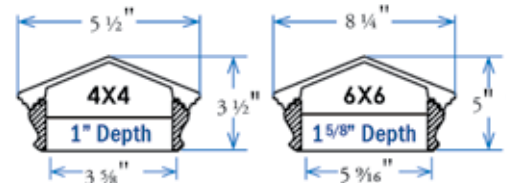

THIS CAP IS ALSO AVAILABLE WITH A LIGHT OPTION, PLEASE SEE THE LOW VOLTAGE LIGHTING SECTION FOR MORE INFORMATION  
THIS CAP MAY BE USED ON MORE POST SIZES BY CHANGING THE BASE, PLEASE SEE PAGE 151 FOR MORE OPTIONS



### Dekpro™ Pyramid Post Cap - Bronze

Sold in any quantity.

Powder coated aluminum pyramid post cap with skirt. 2 ea. screws included, some assembly required.

Item #: DP35PBZ - 3-5/8" X 3-5/8"  
Item #: DP4PBZ - 4" X 4"  
Item #: DP43PBZ - 4-3/8" X 4-3/8"  
Item #: DP55PBZ - 5-5/8" X 5-5/8"  
Item #: DP6PBZ - 6-1/16" X 6-1/16"

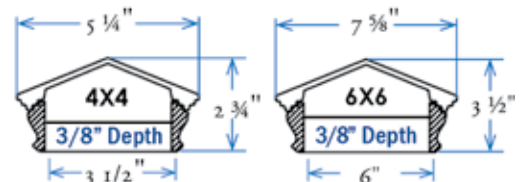



## Modular Aluminum Post Cap System

(Fits post sizes 3-5/8" 4", 4-3/8", 5-5/8", and 6")

Innovative modular post cap system by DekPro™ Manufacturing. Maximizes versatility by allowing you to pick your components to achieve the desired color combination and size.



Choose:



Or



Then



If Necessary



(OPTIONAL)

### Bronze Modular Pyramid Aluminum Post Cap

Sold in any quantity.

Item #: DPMCP35BZ - Pyramid portion for use with 3-5/8" X 3-5/8" base shown below.

Item #: DPMCP43BZ - Pyramid portion for use with 4-3/8" X 4-3/8" base shown below.

Item #: DPMCP6BZ - Pyramid portion for use with 6" X 6" base shown below.

### Bronze Modular Flat Aluminum Post Cap

Sold in any quantity.

Item #: DPMCF35BZ - Flat top portion for use with 3-5/8" X 3-5/8" base shown below.

Item #: DPMCF43BZ - Flat top portion for use with 4-3/8" X 4-3/8" base shown below.

Item #: DPMCF6BZ - Flat top portion for use with 6" X 6" base shown below.

### Bronze Base for Modular Post Cap

Sold in any quantity.

Item #: DPMB35BZ - Base portion for use with 3-5/8" X 3-5/8" tops shown above.

Item #: DPMB43BZ - Base portion for use with 4-3/8" X 4-3/8" tops shown above.

Item #: DPMB6BZ - Base portion for use with 6" X 6" tops shown above.

### Adapter Ring For More Post Cap Options

Sold in any quantity.

Item #: DPMA4B - Adaptor ring for use with 4-3/8" X 4-3/8" base shown above to adapt to a 4" post.

Item #: DPMA5B - Adaptor ring for use with 6" X 6" base shown above to adapt to a 5-5/8" X 5-5/8" post.

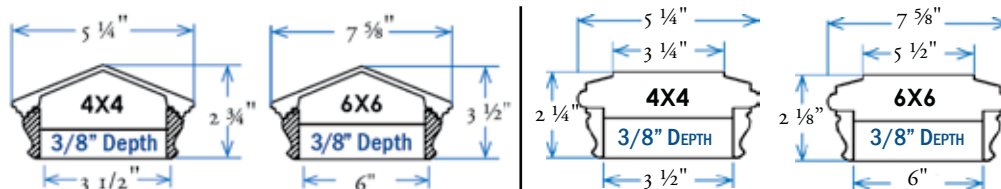



### Titan Flat Top All Aluminum Post Cap - Bronze

Sold in any quantity.

Aluminum flat top post cap with aluminum skirt. (Fasteners Included)

- Item #: PCA-5035 - 3-5/8" X 3-5/8"
- Item #: RLAC-6045 - 4-1/16" X 4-1/16"
- Item #: CLAC-6045 - 4-3/8" X 4-3/8"
- Item #: PCA-8035 - 5-9/16" X 5-9/16"

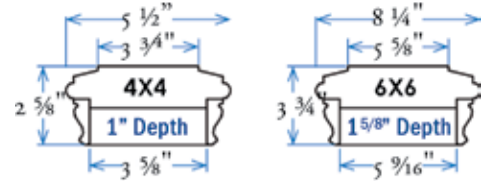

THIS CAP IS ALSO AVAILABLE WITH A LIGHT OPTION, PLEASE SEE THE LOW VOLTAGE LIGHTING SECTION FOR MORE INFORMATION

THIS CAP MAY BE USED ON MORE POST SIZES BY CHANGING THE BASE, PLEASE SEE PAGE 151 FOR MORE OPTIONS



### Dekpro™ Flat Top Post Cap - Bronze

Sold in any quantity.

Powder coated aluminum flat top post cap with skirt. 2 ea. screws included, some assembly required.

- Item #: DP35FBZ - 3-5/8" X 3-5/8"
- Item #: DP4FBZ - 4" X 4"
- Item #: DP43FBZ - 4-3/8" X 4-3/8"
- Item #: DP55FBZ - 5-5/8" X 5-5/8"
- Item #: DP6FBZ - 6-1/16" X 6-1/16"

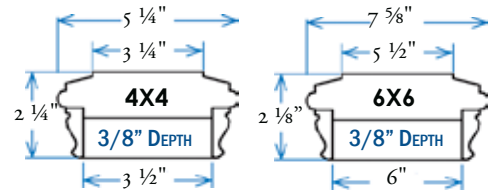

### Rondi Textured Unlit Post Cap - Oil Rubbed Bronze

Sold in any quantity.

Oil rubbed bronze Rondi post cap made from high quality sand cast aluminum and is available in 6 different sizes to fit a wide array of wood and composite post sizes.

- Item #: PCLR07 - 3-5/8"
- Item #: PCR4107 - 4-1/8"
- Item #: PCR07 - 4-9/16"
- Item #: PCR5107 - 5-1/8"
- Item #: PCG07 - 5-5/8"
- Item #: PCBK07 - 6-1/16"

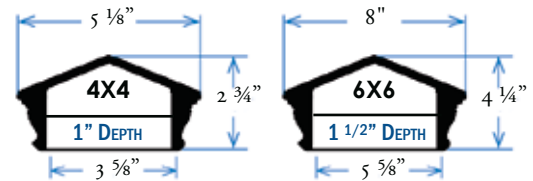

THIS CAP IS ALSO AVAILABLE WITH A LIGHT OPTION, PLEASE SEE THE LOW VOLTAGE LIGHTING SECTION FOR MORE INFORMATION



### Aluminum Post Point - Bronze

Sold in any quantity.

Bronze aluminum post point.

- Item #: DPPP35BZ - Bronze - 3-5/8" X 3-5/8"
- Item #: DPPP6BZ - Bronze - 5-5/8" X 5-5/8"

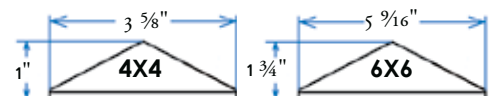



## Modular Aluminum Post Cap System

(Fits post sizes 3-5/8" 4", 4-3/8", 5-5/8", and 6")

Innovative modular post cap system by DekPro™ Manufacturing. Maximizes versatility by allowing you to pick your components to achieve the desired color combination and size.



Choose:



Or



Then



If Necessary



(OPTIONAL)

### White Modular Pyramid Aluminum Post Cap

Sold in any quantity.

Item #: DPMCP35W - Pyramid portion for use with 3-5/8" X 3-5/8" base shown below.

Item #: DPMCP43W - Pyramid portion for use with 4-3/8" X 4-3/8" base shown below.

Item #: DPMCP6W - Pyramid portion for use with 6" X 6" base shown below.

### White Modular Flat Aluminum Post Cap

Sold in any quantity.

Item #: DPMCF35W - Flat top portion for use with 3-5/8" X 3-5/8" base shown below.

Item #: DPMCF43W - Flat top portion for use with 4-3/8" X 4-3/8" base shown below.

Item #: DPMCF6W - Flat top portion for use with 6" X 6" base shown below.

### White Base for Modular Post Cap

Sold in any quantity.

Item #: DPMB35W - Base portion for use with 3-5/8" X 3-5/8" tops shown above.

Item #: DPMB43W - Base portion for use with 4-3/8" X 4-3/8" tops shown above.

Item #: DPMB6W - Base portion for use with 6" X 6" tops shown above.

### Adapter Ring For More Post Cap Options

Sold in any quantity.

Item #: DPMA4W - Adaptor ring for use with 4-3/8" X 4-3/8" base shown above to adapt to a 4" post.

Item #: DPMA5W - Adaptor ring for use with 6" X 6" base shown above to adapt to a 5-5/8" X 5-5/8" post.

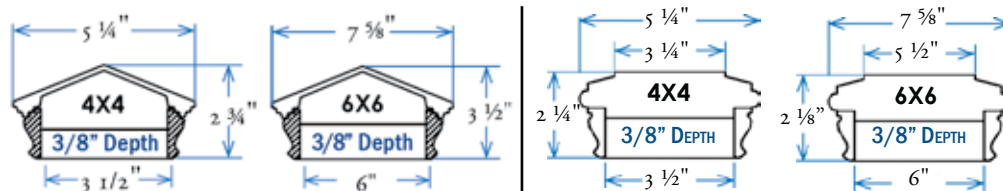



### Sirius Pyramid All Aluminum Post Cap - White

Sold in any quantity.

Aluminum pyramid post cap with aluminum skirt. (Fasteners Included)

- Item #: PCA-5060 - 3-5/8" X 3-5/8"
- Item #: RLAC-6050 - 4-1/16" X 4-1/16"
- Item #: FLAC-6050 - 5-1/16" X 5-1/16"
- Item #: PCA-8060 - 5-9/16" X 5-9/16"

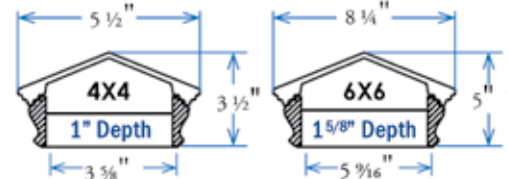

THIS CAP IS ALSO AVAILABLE WITH A LIGHT OPTION, PLEASE SEE THE LOW VOLTAGE LIGHTING SECTION FOR MORE INFORMATION  
 THIS CAP MAY BE USED ON MORE POST SIZES BY CHANGING THE BASE, PLEASE SEE PAGE 151 FOR MORE OPTIONS



### Dekpro™ Pyramid Post Cap - White

Sold in any quantity.

Powder coated aluminum pyramid post cap with skirt. 2 ea. screws included, some assembly required.

- Item #: DP35PWH - 3-5/8" X 3-5/8"
- Item #: DP4PWH - 4" X 4"
- Item #: DP43PWH - 4-3/8" X 4-3/8"
- Item #: DP55PWH - 5-5/8" X 5-5/8"
- Item #: DP6PWH - 6-1/16" X 6-1/16"

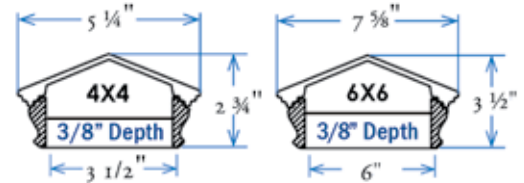

### Accents Flat Aluminum Cap - White

Sold in any quantity.

Accents flat die cast aluminum post cap adapts to many different post sizes. (Optional LED light kit sold separately)

- Item #: 52500031 - 3" X 3"
- Item #: 52500351 - 3-5/8" X 3-5/8"
- Item #: 52500041 - 4" X 4"
- Item #: 52500051 - 5" X 5" and \*4-1/2" X 4-1/2"  
 \*Adapter ring included for 4-1/2" version
- Item #: 52506001 - White - 6" X 6" and \*5-5/8" X 5-5/8"  
 \*Adapter ring included for 5-5/8" version

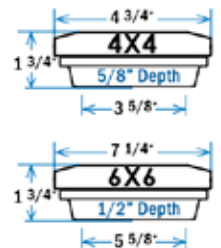

THIS CAP IS ALSO AVAILABLE WITH A LIGHT OPTION, PLEASE SEE THE LOW VOLTAGE LIGHTING SECTION FOR MORE INFORMATION



### Accents Post Skirt - White

Sold in any quantity.

Two piece aluminum post base skirt to match Fortress™ Accents post caps. Comes pre-assembled in packaging, screws included.

- Item #: 52535011 - 3-5/8" Skirt
- Item #: 52504011 - 4" Skirt
- Item #: 52505011 - 5" Skirt (4-1/2" Adaptor included)
- Item #: 52506011 - 6" Skirt (5-5/8" Adaptor included)

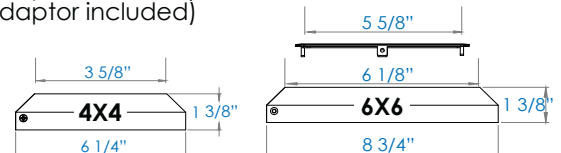

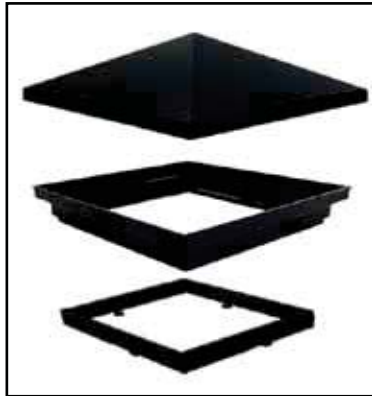

## Modular Aluminum Post Cap System

(Fits post sizes 3-5/8" 4", 4-3/8", 5-5/8", and 6")

Innovative modular post cap system by DekPro™ Manufacturing. Maximizes versatility by allowing you to pick your components to achieve the desired color combination and size.



Choose:



Or



Then



If Necessary



(OPTIONAL)

### Hammered Bronze Modular Pyramid Aluminum Post Cap

Sold in any quantity.

Item #: DPMCP35HB - Pyramid portion for use with 3-1/2" X 3-1/2" base shown below.

Item #: DPMCP43HB - Pyramid portion for use 4-3/8" X 4-3/8" base shown below.

Item #: DPMCP6HB - Pyramid portion for use with 6" X 6" base shown below.

### Hammered Bronze Modular Flat Aluminum Post Cap

Sold in any quantity.

Item #: DPMCF35HB - Flat top portion for use with 3-1/2" X 3-1/2" base shown below.

Item #: DPMCF43HB - Flat top portion for use 4-3/8" X 4-3/8" base shown below.

Item #: DPMCF6HB - Flat top portion for use with 6" X 6" base shown below.

### Hammered Bronze Base for Modular Post Cap

Sold in any quantity.

Item #: DPMB35HB - Base portion for use with 3-1/2" X 3-1/2" tops shown above.

Item #: DPMB43HB - Base portion for use with 4-3/8" X 4-3/8" tops shown above.

Item #: DPMB6HB - Base portion for use with 6" X 6" tops shown above.

### Adapter Ring For More Post Cap Options

Sold in any quantity.

Item #: DPMA4B - Adaptor ring for use with 4-3/8" X 4-3/8" base shown above to adapt to a 4" post.

Item #: DPMA5B - Adaptor ring for use with 6" X 6" base shown above to adapt to a 5-5/8" X 5-5/8" post.

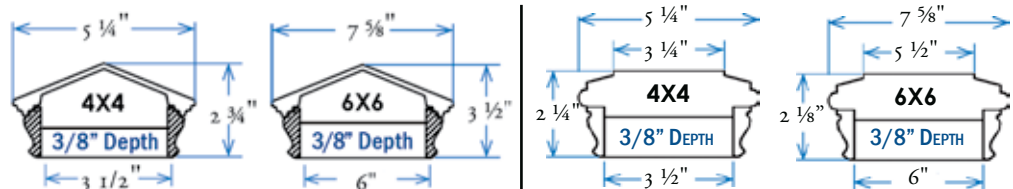



### Titan Flat Top All Aluminum Post Cap - White

Sold in any quantity.

Aluminum flat top post cap with aluminum skirt. (Fasteners Included)

- Item #: PCA-5030 - 3-5/8" X 3-5/8"
- Item #: RLAC-6040 - 4-1/16" X 4-1/16"
- Item #: CLAC-6040 - 4-3/8" X 4-3/8"
- Item #: FLAC-6040 - 5-1/16" X 5-1/16"
- Item #: PCA-8030 - 5-9/16" X 5-9/16"

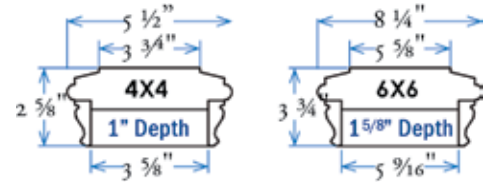

THIS CAP IS ALSO AVAILABLE WITH A LIGHT OPTION, PLEASE SEE THE LOW VOLTAGE LIGHTING SECTION FOR MORE INFORMATION  
 THIS CAP MAY BE USED ON MORE POST SIZES BY CHANGING THE BASE, PLEASE SEE PAGE 151 FOR MORE OPTIONS



### Dekpro™ Flat Top Post Cap - White

Sold in any quantity.

Powder coated aluminum flat top post cap with skirt. 2 ea. screws included, some assembly required.

- Item #: DP35FWH - 3-5/8" X 3-5/8"
- Item #: DP4FWH - 4" X 4"
- Item #: DP43FWH - 4-3/8" X 4-3/8"
- Item #: DP55FWH - 5-5/8" X 5-5/8"
- Item #: DP6FWH - 6-1/16" X 6-1/16"

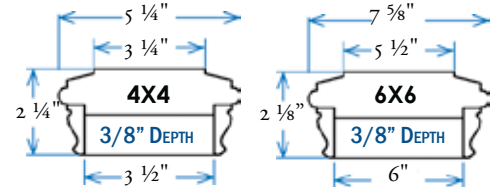

### Rondi Textured Unlit Post Cap - Hammered White

Sold in any quantity.

Hammered white Rondi post cap made from high quality sand cast aluminum and is available in 6 different sizes to fit a wide array of wood and composite post sizes.

- Item #: PCLR01 - 3-5/8"
- Item #: PCR4101 - 4-1/8"
- Item #: PCR01 - 4-9/16"
- Item #: PCR5101 - 5-1/8"
- Item #: PCG01 - 5-5/8"
- Item #: PCBK01 - 6-1/16"

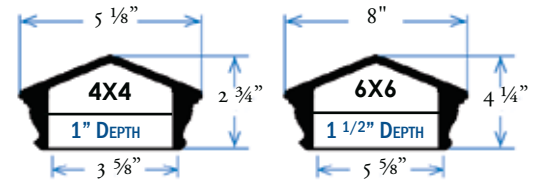

THIS CAP IS ALSO AVAILABLE WITH A LIGHT OPTION, PLEASE SEE THE LOW VOLTAGE LIGHTING SECTION FOR MORE INFORMATION



### Dekpro™ Pyramid Post Cap - Hammered Bronze

Sold in any quantity.

Powder coated aluminum pyramid post cap with skirt. 2 ea. screws included, some assembly required.

- Item #: DP35PHB - 3-5/8" X 3-5/8"
- Item #: DP4PHB - 4" X 4"
- Item #: DP43PHB - 4-3/8" X 4-3/8"
- Item #: DP55PHB - 5-5/8" X 5-5/8"
- Item #: DP6PHB - 6-1/16" X 6-1/16"

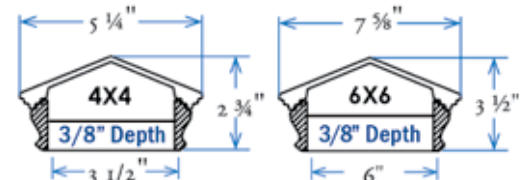



## Accents Textured Flat Aluminum Cap - Antique Bronze

Sold in any quantity.

Accents flat die cast aluminum post cap adapts to many different post sizes.  
(Optional LED light kit sold separately)

- Item #: 52500026 - 2" X 2"
- Item #: 52500036 - 3" X 3"
- Item #: 52500356 - 3-5/8" X 3-5/8"
- Item #: 52500046 - 4" X 4"
- Item #: 52500056 - 5" X 5" and \*4-1/2" X 4-1/2"  
\*Adapter ring included for 4-1/2" version
- Item #: 52506006 - Antique Bronze - 6" X 6" and \*5-5/8" X 5-5/8"  
\*Adapter ring included for 5-5/8" version

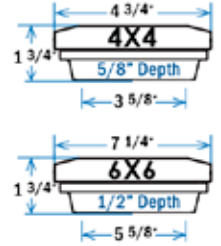

THIS CAP IS ALSO AVAILABLE WITH A LIGHT OPTION, PLEASE SEE THE LOW VOLTAGE LIGHTING SECTION FOR MORE INFORMATION



## Accents Textured Post Skirt - Antique Bronze

Sold in any quantity.

Two piece aluminum post base skirt to match Fortress™ Accents post caps.  
Comes pre-assembled in packaging, screws included.

- Item #: 52535016 - 3-5/8" Skirt
- Item #: 52504016 - 4" Skirt
- Item #: 52505016 - 5" Skirt (4-1/2" Adaptor included)
- Item #: 52506016 - 6" Skirt (5-5/8" Adaptor included)

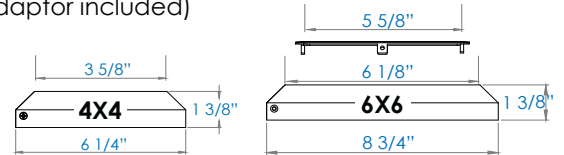

## Dekpro™ Flat Top Post Cap - Hammered Bronze

Sold in any quantity.

Powder coated aluminum flat top post cap with skirt. 2 ea. screws included, some assembly required.

- Item #: DP35FHB - 3-5/8" X 3-5/8"
- Item #: DP4FHB - 4" X 4"
- Item #: DP43FHB - 4-3/8" X 4-3/8"
- Item #: DP55FHB - 5-5/8" X 5-5/8"
- Item #: DP6FHB - 6-1/16" X 6-1/16"

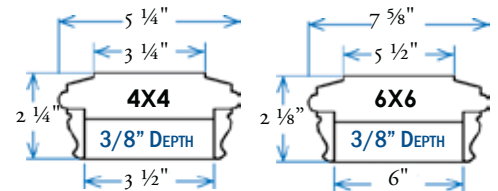

## Rondi Textured Unlit Post Cap - Dark Copper Vein

Sold in any quantity.

Dark copper vein Rondi post cap made from high quality sand cast aluminum and is available in 6 different sizes to fit a wide array of wood and composite post sizes.

- Item #: PCLR10 - 3-5/8"
- Item #: PCR4110 - 4-1/8"
- Item #: PCR10 - 4-9/16"
- Item #: PCR5110 - 5-1/8"
- Item #: PCG10 - 5-5/8"
- Item #: PCBK10 - 6-1/16"

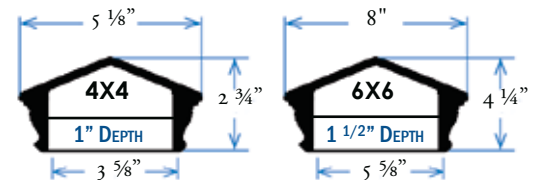

THIS CAP IS ALSO AVAILABLE WITH A LIGHT OPTION, PLEASE SEE THE LOW VOLTAGE LIGHTING SECTION FOR MORE INFORMATION





Available in:

- White
- Bronze
- Black

### Base Converter for 4-1/16"

Sold in any quantity.

Base, converts lights and caps to fit 4-1/16" post. This base converter must be used with 5000 or 6000 series post caps. EX: PCA5068

- Item #: RLAP-6040 - White
- Item #: RLAP-6045 - Bronze
- Item #: RLAP-6048 - Black

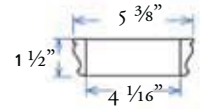

Available in:

- White
- Bronze
- Black

### Base Converter for 4-3/8"

Sold in any quantity.

Base, converts lights and caps to fit 4-3/8" composite posts. This base converter must be used with 5000 or 6000 series post caps. EX: PCA5068

- Item #: CLAP-6040 - White
- Item #: CLAP-6045 - Bronze
- Item #: CLAP-6048 - Black

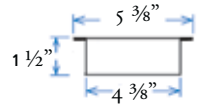

Available in:

- White
- Bronze
- Black

### Base Converter for 4-5/8"

Sold in any quantity.

Base, converts lights and caps to fit 4-5/8" post. This base converter must be used with 5000 or 6000 series post caps. EX: PCA5068

- Item #: TLAP-6040 - White
- Item #: TLAP-6045 - Bronze
- Item #: TLAP-6048 - Black

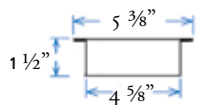

Available in:

- White
- Bronze
- Black

### Base Converter for 5-1/8"

Sold in any quantity.

Base, converts lights and caps to fit 5-1/8" post. This base converter must be used with 5000 or 6000 series post caps. EX: PCA5068

- Item #: FLAP-6040 - White
- Item #: FLAP-6045 - Bronze
- Item #: FLAP-6048 - Black

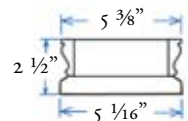

Available in:

- White
- Bronze
- Black

### Base Converter for 6-1/16"

Sold in any quantity.

Base, converts lights and caps to fit 6-1/16" post. To be used **ONLY** with **5-5/8" 8000 Series** post caps and lights.

- Item #: GLAP-8040 - White
- Item #: GLAP-8048 - Black

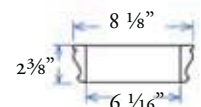

**ADI™**

# DECK LIGHTING



**Low Voltage Post Caps** pg 154 - 160

**Low Voltage Lighting** pg 162 - 171

**Transformers , Timers, Wiring  
and Accessories** pg 172 - 177

**Incandescent Lighting** pg 178 - 180



### Iris Anello Pyramid - Black

Sold in any quantity.

Aluminum pyramid top with LED band light draws 1 watt total per cap, may be powered with an AC or DC output transformer. Light color - 3000 - 3500K.

- Item #: DLA-7058 - 3-5/8" X 3-5/8"
- Item #: RLA-7058 - 4-1/16" x 4-1/16"
- Item #: CLA-7058 - 4-3/8" x 4-3/8"
- Item #: \*TLA-7058 - 4-5/8" x 4-5/8"
- Item #: \*FLA-7058 - 5-1/8" x 5-1/8"

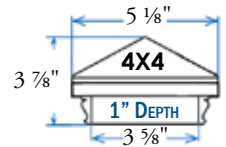

### Accents Textured Down Light Cap - Black Sand

Sold in any quantity.

Accents flat die cast aluminum post cap adapts to many different post sizes. (Must purchase LED cap light kit along with the cap below). Light kit draws 2 watts. Light color - 2600K. Includes wire nuts and 60" lead wire.

- Item #: 52500028 - 2" X 2"
- Item #: 52500038 - 3" X 3"
- Item #: 52500358 - 3-5/8" X 3-5/8"
- Item #: 52500048 - 4" X 4"
- Item #: 52500058 - 5" X 5" and \*4-1/2" X 4-1/2"
- \*Adapter ring included for 4-1/2" version
- Item #: 52506008 - 6" X 6" and \*5-5/8" X 5-5/8"
- \*Adapter ring included for 5-5/8" version



Item #: 52500000



### Accents Textured Glow Ring Cap - Black Sand

Sold in any quantity.

Accents flat die cast aluminum post cap adapts to many different post sizes. (Must purchase LED glow ring light kit along with the cap below). Glow ring draws 1.5 watts. Light color - 2600K. Includes wire nuts and 60" lead wire.

- Item #: 52500028 + 52502020 - Cap with Glow Ring - 2" X 2"
- Item #: 52500038 + 52503030 - Cap with Glow Ring - 3" X 3"
- Item #: 52500358 + 52535350 - Cap with Glow Ring - 3-5/8" X 3-5/8"
- Item #: 52500048 + 52504040 - Cap with Glow Ring - 4" X 4"
- Item #: 52500058 + 52505050 - Cap with Glow Ring - 5" X 5" and \*4-1/2" X 4-1/2"
- \*Adapter ring included for 4-1/2" version
- Item #: 52506008 + 52506060 - Cap with Glow Ring - 6" X 6" and \*5-5/8" X 5-5/8"
- \*Adapter ring included for 5-5/8" version



### Accents Textured Post Skirt - Black Sand

Sold in any quantity.

Two piece aluminum post base skirt to match Fortress™ Accents post caps. Comes pre-assembled in packaging, screws included.

- Item #: 52535018 - 3-5/8" Skirt
- Item #: 52504018 - 4" Skirt
- Item #: 52505018 - 5" Skirt (4-1/2" Adaptor included)
- Item #: 52506018 - 6" Skirt (5-5/8" Adaptor included)

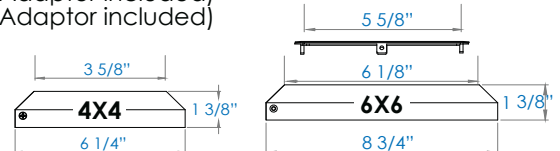



## Accents Down Light Cap - Gloss Black

Sold in any quantity.

Accents flat die cast aluminum post cap adapts to many different post sizes. (Must purchase LED cap light kit along with the cap below). Light kit draws 2 watts. Light color - 2600K. Includes wire nuts and 60" lead wire.

- Item #: 52500020 - 2" X 2"
- Item #: 52500030 - 3" X 3"
- Item #: 52500350 - 3-5/8" X 3-5/8"
- Item #: 52500040 - 4" X 4"
- Item #: 52500050 - 5" X 5" and \*4-1/2" X 4-1/2"  
\*Adapter ring included for 4-1/2" version
- Item #: 52506000 - 6" X 6" and \*5-5/8" X 5-5/8"  
\*Adapter ring included for 5-5/8" version



## Accents Glow Ring Cap - Gloss Black

Sold in any quantity.

Accents flat die cast aluminum post cap adapts to many different post sizes. (Must purchase LED glow ring light kit along with the cap below). Glow ring draws 1.5 watts. Light color - 2600K. Includes wire nuts and 60" lead wire.

- Item #: 52500020 + 52502020 - Cap with Glow Ring - 2" X 2"
- Item #: 52500030 + 52503030 - Cap with Glow Ring - 3" X 3"
- Item #: 52500350 + 52535350 - Cap with Glow Ring - 3-5/8" X 3-5/8"
- Item #: 52500040 + 52504040 - Cap with Glow Ring - 4" X 4"
- Item #: 52500050 + 52505050 - Cap with Glow Ring - 5" X 5" and \*4-1/2" X 4-1/2"  
\*Adapter ring included for 4-1/2" version
- Item #: 52506000 + 52506060 - Cap with Glow Ring - 6" X 6" and \*5-5/8" X 5-5/8"  
\*Adapter ring included for 5-5/8" version



## Accents Post Skirt - Gloss Black

Sold in any quantity.

Two piece aluminum post base skirt to match Fortress™ Accents post caps. Comes pre-assembled in packaging, screws included.

- Item #: 52535010 - 3-5/8" Skirt
- Item #: 52504010 - 4" Skirt
- Item #: 52505010 - 5" Skirt (4-1/2" Adaptor included)
- Item #: 52506010 - 6" Skirt (5-5/8" Adaptor included)

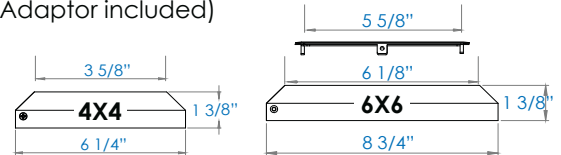

## Saturn Anello Flat Top - Black

Sold in any quantity.

Aluminum flat top with LED band light draws 1 watt total per cap, may be powered with an AC or DC output transformer. Light color - 3000 - 3500K.

- Item #: DLA-7048 - 3-5/8" X 3-5/8"
- Item #: RLA-7048 - 4-1/16" x 4-1/16"
- Item #: CLA-7048 - 4-3/8" x 4-3/8"
- Item #: TLA-7048 - 4-5/8" x 4-5/8"
- Item #: FLA-7048 - 5-1/8" x 5-1/8"

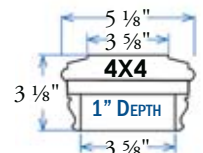



### Rondi Textured Lit Post Cap - Antique Black

Sold in any quantity.

Antique textured black Rondi post cap illuminated on 4 sides with 4 LED's per side and is made from high quality sand cast aluminum. Must use with Dekor™ EZ series transformers sold separately. Cap draws 4.8 watts. Light color - 3200K.

Item #: PCLRL4S05 - 3-1/2"  
Item #: PCR41L4S05 - 4-1/8"



Plug and Play Connectors

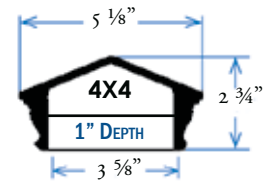

### Rondi Textured Lit Post Cap - Antique Black

Sold in any quantity.

Antique textured black Rondi post cap illuminated on 4 sides with 6 LED's per side and is made from high quality sand cast aluminum. Must use with Dekor™ EZ series transformers sold separately. Cap draws 7.2 watts. Light color - 3200K.

Item #: PCRL4S05 - 4-9/16"  
Item #: PCR51L4S05 - 5-1/8"  
Item #: PCGL4S05 - 5-5/8"  
Item #: PCBKL4S05 - 6-1/16"



Plug and Play Connectors

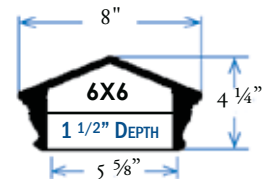

### Iris Anello Pyramid - Bronze

Sold in any quantity.

Aluminum pyramid top with LED band light draws 1 watt total per cap, may be powered with an AC or DC output transformer. Light color - 3000 - 3500K.

Item #: DLA-7055 - 3-5/8" X 3-5/8"  
Item #: RLA-7055 - 4-1/16" x 4-1/16"  
Item #: CLA-7055 - 4-3/8" x 4-3/8"  
Item #: \*TLA-7055 - 4-5/8" x 4-5/8"  
Item #: \*FLA-7055 - 5-1/8" x 5-1/8"

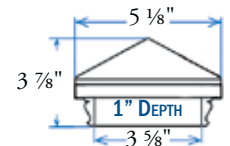

### Accents Textured Down Light Cap - Antique Bronze

Sold in any quantity.

Accents flat die cast aluminum post cap adapts to many different post sizes. (Must purchase LED cap light kit along with the cap below). Light kit draws 2 watts. Light color - 2600K. Includes wire nuts and 60" lead wire.

Item #: 52500026 - 2" X 2"  
Item #: 52500036 - 3" X 3"  
Item #: 52500356 - 3-5/8" X 3-5/8"  
Item #: 52500046 - 4" X 4"  
Item #: 52500056 - 5" X 5" and \*4-1/2" X 4-1/2"  
\*Adapter ring included for 4-1/2" version  
Item #: 52506006 - 6" X 6" and \*5-5/8" X 5-5/8"  
\*Adapter ring included for 5-5/8" version



Item #: 52500000



### Accents Textured Glow Ring Cap - Antique Bronze

Sold in any quantity.

Accents flat die cast aluminum post cap adapts to many different post sizes. (Must purchase LED glow ring light kit along with the cap below). Glow ring draws 1.5 watts. Light color - 2600K. Includes wire nuts and 60" lead wire.

- Item #: 52500026 + 52502020 - Cap with Glow Ring - 2" X 2"
- Item #: 52500036 + 52503030 - Cap with Glow Ring - 3" X 3"
- Item #: 52500356 + 52535350 - Cap with Glow Ring - 3-5/8" X 3-5/8"
- Item #: 52500046 + 52504040 - Cap with Glow Ring - 4" X 4"
- Item #: 52500056 + 52505050 - Cap with Glow Ring - 5" X 5" and \*4-1/2" X 4-1/2"  
\*Adapter ring included for 4-1/2" version
- Item #: 52506006 + 52506060 - Cap with Glow Ring - 6" X 6"  
and \*5-5/8" X 5-5/8"  
\*Adapter ring included for 5-5/8" version



### Accents Textured Post Skirt - Antique Bronze

Sold in any quantity.

Two piece aluminum post base skirt to match Fortress™ Accents post caps. Comes pre-assembled in packaging, screws included.

- Item #: 52535016 - 3-5/8" Skirt
- Item #: 52504016 - 4" Skirt
- Item #: 52505016 - 5" Skirt (4-1/2" Adaptor included)
- Item #: 52506016 - 6" Skirt (5-5/8" Adaptor included)

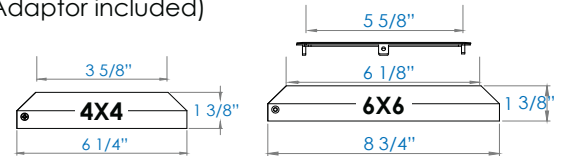

### Rondi Textured Lit Post Cap - Oil Rubbed Bronze

Sold in any quantity.

Oil rubbed bronze Rondi post cap illuminated on 4 sides with 4 LED's per side and is made from high quality sand cast aluminum. Must use with Dekor™ EZ series transformers sold separately. Cap draws 4.8 watts. Light color - 3200K.

- Item #: PCLRL4S07 - 3-5/8"
- Item #: PCR41L4S07 - 4-1/8"



Plug and Play Connectors

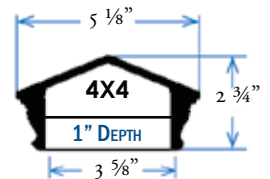

### Rondi Textured Lit Post Cap - Oil Rubbed Bronze

Sold in any quantity.

Oil rubbed bronze Rondi post cap illuminated on 4 sides with 6 LED's per side and is made from high quality sand cast aluminum. Must use with Dekor™ EZ series transformers sold separately. Cap draws 7.2 watts. Light color - 3200K.

- Item #: PCRL4S07 - 4-9/16"
- Item #: PCR51L4S07 - 5-1/8"
- Item #: PCGL4S07 - 5-5/8"
- Item #: PCBKL4S07 - 6-1/16"



Plug and Play Connectors

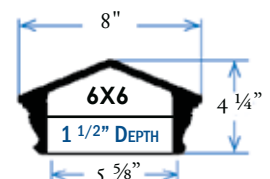



### Saturn Anello Flat Top - Bronze

Sold in any quantity.

Aluminum flat top with LED band light draws 1 watt total per cap, may be powered with an AC or DC output transformer. Light color - 3000 - 3500K.

- Item #: DLA-7045 - 3-5/8" X 3-5/8"
- Item #: RLA-7045 - 4-1/16" x 4-1/16"
- Item #: CLA-7045 - 4-3/8" x 4-3/8"
- Item #: \*TLA-7045 - 4-5/8" x 4-5/8"
- Item #: \*FLA-7045 - 5-1/8" x 5-1/8"

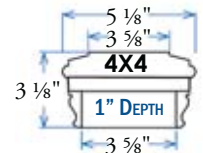

### Accents Down Light Cap - White

Sold in any quantity.

Accents flat die cast aluminum post cap adapts to many different post sizes. (Must purchase LED cap light kit along with the cap below). Light kit draws 2 watts. Light color - 2600K. Includes wire nuts and 60" lead wire.

- Item #: 52500031 - 3" X 3"
- Item #: 52500351 - 3-5/8" X 3-5/8"
- Item #: 52500041 - 4" X 4"
- Item #: 52500051 - 5" X 5" and \*4-1/2" X 4-1/2"  
\*Adapter ring included for 4-1/2" version
- Item #: 52506001 - 6" X 6" and \*5-5/8" X 5-5/8"  
\*Adapter ring included for 5-5/8" version



### Accents Glow Ring Cap - White

Sold in any quantity.

Accents flat die cast aluminum post cap adapts to many different post sizes. (Must purchase LED glow ring light kit along with the cap below). Glow ring draws 1.5 watts. Light color - 2600K. Includes wire nuts and 60" lead wire.

- Item #: 52500031 + 52503030 - Cap with Glow Ring - 3" X 3"
- Item #: 52500351 + 52535350 - Cap with Glow Ring - 3-5/8" X 3-5/8"
- Item #: 52500041 + 52504040 - Cap with Glow Ring - 4" X 4"
- Item #: 52500051 + 52505050 - Cap with Glow Ring - 5" X 5" and \*4-1/2" X 4-1/2"  
\*Adapter ring included for 4-1/2" version
- Item #: 52506001 + 52506060 - White Cap with Glow Ring - 6" X 6" and \*5-5/8" X 5-5/8"  
\*Adapter ring included for 5-5/8" version



### Accents Post Skirt - White

Sold in any quantity.

Two piece aluminum post base skirt to match Fortress™ Accents post caps. Comes pre-assembled in packaging, screws included.

- Item #: 52535011 - 3-5/8" Skirt
- Item #: 52504011 - 4" Skirt
- Item #: 52505011 - 5" Skirt (4-1/2" Adaptor included)
- Item #: 52506011 - 6" Skirt (5-5/8" Adaptor included)

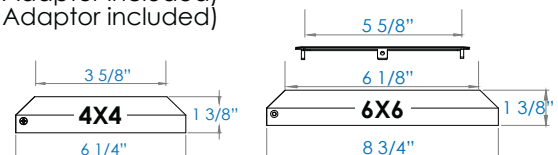





### Iris Anello Pyramid - White

Sold in any quantity.

Aluminum pyramid top with LED band light draws 1 watt total per cap, may be powered with an AC or DC output transformer. Light color - 3000 - 3500K.

- Item #: DLA-7050 - 3-5/8" X 3-5/8"
- Item #: RLA-7050 - 4-1/16" x 4-1/16"
- Item #: \*CLA-7050 - 4-3/8" x 4-3/8"
- Item #: TLA-7050 - 4-5/8" x 4-5/8"
- Item #: \*FLA-7050 - 5-1/8" x 5-1/8"

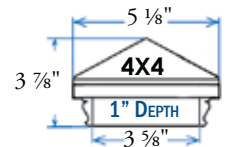

### Saturn Anello Flat Top - White

Sold in any quantity.

Aluminum flat top with LED band light draws 1 watt total per cap, may be powered with an AC or DC output transformer. Light color - 3000 - 3500K.

- Item #: DLA-7040 - 3-5/8" X 3-5/8"
- Item #: RLA-7040 - 4-1/16" x 4-1/16"
- Item #: CLA-7040 - 4-3/8" x 4-3/8"
- Item #: TLA-7040 - 4-5/8" x 4-5/8"
- Item #: FLA-7040 - 5-1/8" x 5-1/8"

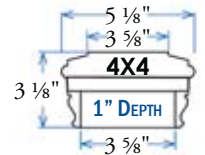

### Rondi Textured Lit Post Cap - Hammered White

Sold in any quantity.

Hammered white Rondi post cap illuminated on 4 sides with 4 LED's per side and is made from high quality sand cast aluminum. Must use with Dekor™ EZ series transformers sold separately. Cap draws 4.8 watts. Light color - 3200K.

- Item #: PCLRL4S01 - 3-5/8"
- Item #: PCR41L4S01 - 4-1/8"

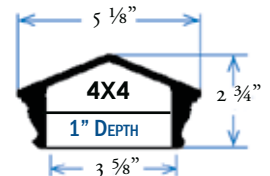

Plug and Play Connectors



### Rondi Textured Lit Post Cap - Hammered White

Sold in any quantity.

Hammered white Rondi post cap illuminated on 4 sides with 6 LED's per side and is made from high quality sand cast aluminum. Must use with Dekor™ EZ series transformers sold separately. Cap draws 7.2 watts. Light color - 3200K.

- Item #: PCRL4S01 - 4-9/16"
- Item #: PCR51L4S01 - 5-1/8"
- Item #: PCGL4S01 - 5-5/8"
- Item #: PCBKL4S01 - 6-1/16"

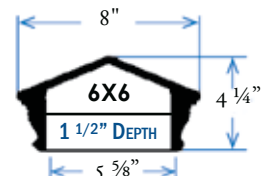

Plug and Play Connectors



### Rondi Textured Lit Post Cap - Dark Copper Vein

Sold in any quantity.

Dark copper vein Rondi post cap illuminated on 4 sides with 4 LED's per side and is made from high quality sand cast aluminum. Must use with Dekor™ EZ series transformers sold separately. Cap draws 4.8 watts. Light color - 3200K.

Item #: PCLRL4S10 - 3-5/8"  
Item #: PCR41L4S10 - 4-1/8"



Plug and Play Connectors

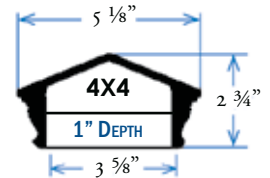

### Rondi Textured Lit Post Cap - Dark Copper Vein

Sold in any quantity.

Dark copper vein Rondi post cap illuminated on 4 sides with 6 LED's per side and is made from high quality sand cast aluminum. Must use with Dekor™ EZ series transformers sold separately. Cap draws 7.2 watts. Light color - 3200K.

Item #: PCRL4S10 - 4-9/16"  
Item #: PCR51L4S10 - 5-1/8"  
Item #: PCGL4S10 - 5-5/8"  
Item #: PCBKL4S10 - 6-1/16"



Plug and Play Connectors

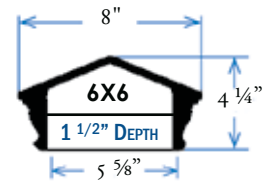



Available in:

- White
- Bronze
- Black

### Base Converter for 4-1/16"

Sold in any quantity.

Base, converts lights and caps to fit 4-1/16" post. This base converter must be used with 5000 or 6000 series post caps. EX: PCA5068

- Item #: RLAP-6040 - White
- Item #: RLAP-6045 - Bronze
- Item #: RLAP-6048 - Black

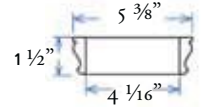

Available in:

- White
- Bronze
- Black

### Base Converter for 4-3/8"

Sold in any quantity.

Base, converts lights and caps to fit 4-3/8" composite posts. This base converter must be used with 5000 or 6000 series post caps. EX: PCA5068

- Item #: CLAP-6040 - White
- Item #: CLAP-6045 - Bronze
- Item #: CLAP-6048 - Black

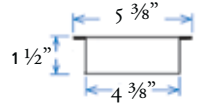

Available in:

- White
- Bronze
- Black

### Base Converter for 4-5/8"

Sold in any quantity.

Base, converts lights and caps to fit 4-5/8" post. This base converter must be used with 5000 or 6000 series post caps. EX: PCA5068

- Item #: TLAP-6040 - White
- Item #: TLAP-6045 - Bronze
- Item #: TLAP-6048 - Black

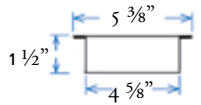

Available in:

- White
- Bronze
- Black

### Base Converter for 5-1/8"

Sold in any quantity.

Base, converts lights and caps to fit 5-1/8" post. This base converter must be used with 5000 or 6000 series post caps. EX: PCA5068

- Item #: FLAP-6040 - White
- Item #: FLAP-6045 - Bronze
- Item #: FLAP-6048 - Black

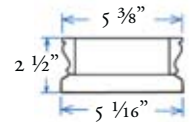

Available in:

- White
- Black

### Base Converter for 6-1/16"

Sold in any quantity.

Base, converts lights and caps to fit 6-1/16" post. To be used **ONLY** with **5-5/8" 8000 Series** post caps and lights.

- Item #: GLAP-8040 - White
- Item #: GLAP-8048 - Black

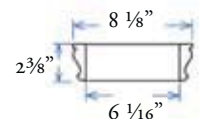



Available in:

- Black
- Bronze
- White

## Vega Post Light

Sold in any quantity.

Vega LED post light draws 1 watt of power and may be powered with an AC or DC output transformer. Measures 3-1/4"W x 2-3/8"H. Light color - 3000 - 3500K.

- Item #: PLA-8008 - Black
- Item #: PLA-8005 - Bronze
- Item #: PLA-8000 - White (shown)



Available in:

- Black
- Bronze
- White

## Mini Vega Post Light

Sold in any quantity.

Mini Vega LED post light draws 1 watt of power and may be powered with an AC or DC output transformer. Measures 1-3/4"W x 1-1/4"H. Light color - 3000 - 3500K.

- Item #: PLA-8508 - Black
- Item #: PLA-8505 - Bronze (shown)
- Item #: PLA-8500 - White



Available in:

- Gloss Black
- Ant. Bronze
- White
- Black Sand

## Accents Vertical Post Light

Sold in box of 2.

Accents LED Vertical Post Light are perfect for any post to illuminate deck or walkways. Features .25 watt LED. Measures 3-1/2"W x 1-3/4"H X 7/8"T. Light color - 2600.

- Item # 52500060 - Gloss Black
- Item # 52500066 - Antique Bronze
- Item # 52500061 - White
- Item # 52500068 - Black Sand (Textured) (shown)



Available in:

- Hammered White
- Antique Black
- Oil Rubbed Bronze
- Dark Copper Vein

## Tear Drop Post Light

Sold in any quantity.

LED lighted cast aluminum post lamps with textured finish. Light draws 2.4 watts and features Cree® LED Lights. Measures 3-1/2"W x 4-1/2"H x 2-1/2"T. Light color - 3200K.

- Item # PLTD01 - Hammered White
- Item # PLTD05 - Antique Black
- Item # PLTD07 - Oil Rubbed Bronze
- Item # PLTD10 - Dark Copper Vein (shown)



Plug and Play Connectors



Available in:

- Black
- Bronze
- White

## Nebula Eyeball Post Light

Sold in any quantity.

Nebula LED post light draws 1 watt of power and may be powered with an AC or DC output transformer. Measures 3-1/2" in diameter. Light color - 3000 - 3500K.

- Item #: PLA-5008 - Black
- Item #: PLA-5005 - Bronze (shown)
- Item #: PLA-5000 - White



Available in:

- Black
- Bronze
- White

## Mini Nebula Eyeball Post Light

Sold in any quantity.

Mini Nebula LED post light draws 1 watt of power and may be powered with an AC or DC output transformer. Measures 1-3/4" in diameter. Light color - 3000 - 3500K.

- Item #: PLA-5508 - Black (shown)
- Item #: PLA-5505 - Bronze
- Item #: PLA-5500 - White



Available in:

- Black
- Ant. Bronze
- Ant. Copper

## Estes Post Light

Sold in any quantity.

Surface post mount outdoor deck fixture gently illuminates a 7' to 9' area and features a 1 watt LED bulb with 48" electrical pigtail. May be powered with an AC or DC output transformer. Measures 3-1/2" in diameter. Light color - 3000K.

- Item #: HP571PPCBL - Midnight Black (Textured)
- Item #: HP571PMBRCBL - Antique Bronze (shown)
- Item #: HP571PPCCL - Antique Copper



Available in:

- Hammered White
- Antique Black
- Oil Rubbed Bronze
- Dark Copper Vein

## Elite Post Light

Sold in any quantity.

Bidirectional post lamp with textured finish that mounts to any surface. Can be rotated in any direction. Light draws 1 watt and features Cree® LED Lights. Measures 2-1/2"W x 2-1/2"H x 1/2"T. Light color - 3200K.

- Item # PLE01 - Hammered White
- Item # PLE05 - Antique Black (shown)
- Item # PLE07 - Oil Rubbed Bronze
- Item # PLE10 - Dark Copper Vein



Plug and Play Connectors



Available in:  
 Black  
 Ant. Bronze

## Genesis Post Light

Sold in any quantity.

Surface post mount outdoor deck fixture gently illuminates a 6' to 8' area and features a 1 watt LED bulb with 48" electrical pigtail. May be powered with an AC or DC output transformer. Measures 3-1/2"W x 3-3/4"H x 2"T. Light color - 3000K.

Item #: HP550PPCBL - Midnight Black (Textured)  
 Item #: HP550PMBRL - Antique Bronze (shown)



Available in:  
 Black  
 Ant. Bronze

## Berkley Post Light

Sold in any quantity.

Surface mount outdoor deck fixture gently illuminates a 4' to 6' area and features a 1 watt LED bulb with 48" electrical pigtail. May be powered with an AC or DC output transformer. Measures 3-3/8"W x 4"H x 1-7/8"T. Light color - 3000K.

Item #: HP570PPCBL - Midnight Black (Textured)  
 Item #: HP570PMBRL - Antique Bronze (shown)



Available in:  
 Black  
 Ant. Bronze

## Moab Post Light

Sold in any quantity.

Surface post mount outdoor deck fixture gently illuminates a 6' to 8' area and features a 1 watt LED bulb with 48" electrical pigtail. May be powered with an AC or DC output transformer. Measures 3"W x 3-1/4"H x 1-3/4"T. Light color - 3000K.

Item #: HP512PBLKL - Midnight Black (Textured)  
 Item #: HP512PMBRL - Antique Bronze (shown)

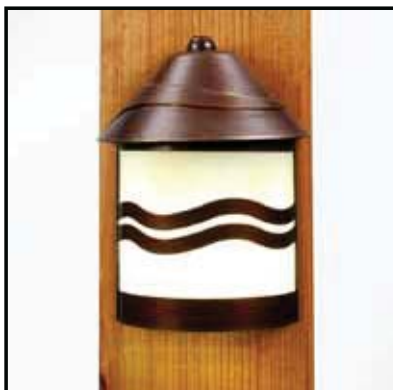

Available in:  
 Black  
 Ant. Bronze

## Lake Powell Post Light

Sold in any quantity.

Surface post mount outdoor deck fixture gently illuminates a 6' to 8' area and features a 1 watt LED bulb with 48" electrical pigtail. May be powered with an AC or DC output transformer. Measures 3-1/2"W x 4-1/2"H x 2-1/4"T. Light color - 3000K.

Item #: HP535PPCBL - Midnight Black (Textured)  
 Item #: HP535PMBRL - Antique Bronze (shown)



- Available in:
- Hammered White
  - Antique Black
  - Oil Rubbed Bronze
  - Dark Copper Vein

## Holly Post Light

Sold in any quantity.

LED lighted cast aluminum post lamp with textured finish. Light draws 2.4 watts and features Cree® LED Lights. Measures 3"W x 4"H x 2-1/4"T. Light color - 3200K

- Item # PLH01 - Hammered White
- Item # PLH05 - Antique Black
- Item # PLH07 - Oil Rubbed Bronze
- Item # PLH10 - Dark Copper Vein (shown)



Plug and Play Connectors



- Available in:
- Black
  - Bronze
  - White

## Up / Down Endurance Rail Light

Sold in any quantity.

Surface mount 1 watt L.E.D light gently illuminates a 3' to 5' area and includes a 12" pigtail. Fixture will work with either AC or DC transformers. Measures 1-5/8"W x 3-1/2"H x 1"T. Light color - 3000K.

- Item #: HP556LPPCB - Midnight Black (shown) (Textured)
- Item #: HP556LMBR - Bronze
- Item #: HP556LPCW - White



- Available in:
- Black
  - Ant. Bronze

## Estes Step Light

Sold in any quantity.

Recessed outdoor step fixture comfortably illuminates a 4' step and features a 1 watt LED bulb with 48" electrical pigtail. May be powered with an AC or DC output transformer. Measures 4"W x 3-1/2"H. Light color - 3000K.

- Item #: HP761RPCBL - Midnight Black (shown) (Textured)
- Item #: HP761RMBRL - Antique Bronze



- Available in:
- Black
  - Bronze
  - White

## Pyxis Recessed Riser Light

Sold in any quantity.

Pyxis louvered recessed riser light illuminated by LED, light draws 1 watt, and fits a rough opening of 2-7/8" x 6-1/8". Fixture measures 7-1/8"W x 3-3/8"H. Light color - 3000 - 3500K.

- Item #: PLA-6008 - Black
- Item #: PLA-6005 - Bronze (shown)
- Item #: PLA-6000 - White



Available in:

- Black
- Bronze
- White

## Corona Recessed Riser Light

Sold in any quantity.

Corona recessed LED light draws 1 watt of power and fits a rough opening of 1-5/8" x 4-1/8". May be powered with an AC or DC output transformer. Measures 4-1/2"W x 2-3/4"H. Light color - 3000 - 3500K.

- Item #: PLA-2008 - Black (shown)
- Item #: PLA-2005 - Bronze
- Item #: PLA-2000 - White



Available in:

- Black
- Ant. Bronze

## Mt. Evans Step Light

Sold in any quantity.

Recessed outdoor step fixture comfortably illuminates a 4' step and features a 1 watt LED bulb with 48" electrical pigtail. May be powered with an AC or DC output transformer. Measures 4"W x 3-1/2"H. Light color - 3000K.

- Item #: HP732RPCBL - Midnight Black (Textured)
- Item #: HP732RMBRL - Antique Bronze (shown)



Available in:

- Black
- Ant. Bronze

## Red Rock 6-Panel Step Light

Sold in any quantity.

Recessed outdoor step light comfortably illuminates a 4' step and includes a 1 watt LED bulb with 48" electrical pigtail. May be powered with an AC or DC output transformer. Measures 8"W x 3"H. Light color - 3000K.

- Item #: HP772RBLKL - Midnight Black (shown) (Textured)
- Item #: HP772RMBRL - Antique Bronze



Available in:

- Gloss Black
- Ant. Bronze
- White
- Black Sand

## Accents Universal Light

Sold in box of 6.

Accents LED universal lights are ideal for any location. Features a .25 watt LED. Measures 2-1/2"W x 5/8"H x 3/8"T. Light color - 2600K.

- Item # 52501000 - Gloss Black
- Item # 52501006 - Antique Bronze
- Item # 52501001 - White (shown)
- Item # 52501008 - Black Sand (Textured)







## Odyssey LED Light Strip Kit

Sold as a kit.

Odyssey series strip LED kit, Contains 4 each 1/8" wide by 3/8" high light strips, also comes with 100' of wire, connectors, transformer and on/off remote. Strips draw approximately 1.5 watts per foot. Transformer (included) will power up to 20' of lighting. Light color - 3000 - 3500K.

- Item #: ODL18K - 4 each 18" LED light strips
- Item #: ODL24K - 4 each 24" LED light strips
- Item #: ODL36K - 4 each 36" LED light strips
- Item #: ODL48K - 4 each 48" LED light strips



Optional light strip housing shown is sold separately below

## Odyssey LED Light Strip

Sold in any quantity.

Odyssey series individual strips, 1/8" wide by 3/8" high each strip fits nicely into 1/8" saw kerf or may be used with optional housings sold below. Must use a DC output transformer such as the ODLDC transformers found on page 172. Includes 2 connection clips per strip. Strips draw approximately 1.5 watts per foot. Light color - 3000 - 3500K.

- Item #: ODL18 - 18" LED light strip
- Item #: ODL24 - 24" LED light strip
- Item #: ODL36 - 36" LED light strip
- Item #: ODL48 - 48" LED light strip



- Item #: ODLCLIP - Additional Connectors



Available in:

- Black
- Bronze
- White

## Odyssey Light Strip Housing Only

Sold in any quantity.

Odyssey powder coated aluminum light strip housings used to hold and secure light strips to flat surfaces.

- Item #: OC18BL - Black 18" housing
- Item #: OC24BL - Black 24" housing
- Item #: OC36BL - Black 36" housing
- Item #: OC48BL - Black 48" housing

- Item #: OC18BR - Bronze 18" housing
- Item #: OC24BR - Bronze 24" housing
- Item #: OC36BR - Bronze 36" housing
- Item #: OC48BR - Bronze 48" housing

- Item #: OC18WH - White 18" housing
- Item #: OC24WH - White 24" housing
- Item #: OC36WH - White 36" housing
- Item #: OC48WH - White 48" housing



Available in:  
 Hammered White  
 Antique Black  
 Oil Rubbed Bronze  
 Dark Copper Vein

## Puck Light

Sold in any quantity.

Unique landscape up light for highlighting trees, shrubs and similar features. Light draws 9.6 watts and features Cree® LED Lights. Measures 2-7/8" in diameter and 1" tall. Light color - 3200K.

- Item #: \*PUCKLL01 - Hammered White
- Item #: PUCKLL05 - Antique Black (shown)
- Item #: \*PUCKLL07 - Oil Rubbed Bronze
- Item #: \*PUCKLL10 - Dark Copper Vein



Plug and Play Connectors



Available in:  
 Hammered White  
 Antique Black  
 Oil Rubbed Bronze  
 Dark Copper Vein

## Petite Directional Light

4 / pack

Aluminum petite light with textured finish can be mounted both indoors and out and may rotated in any direction. Features 1.2 watt Cree® LED Lights. Measures 1-3/8"W x 1-3/8"H. Light color - 3200K.

- Item# DLP401 - Hammered White
- Item# DLP405 - Antique Black
- Item# DLP407 - Oil Rubbed Bronze
- Item# DLP410 - Dark Copper Vein (shown)



Plug and Play Connectors



Available in:  
 Gloss Black  
 Ant. Bronze  
 White  
 Black Sand

## Accents Surface Mount Light

Sold in box of 6.

Accents LED surface mount light can light deck surface, path or stair treads that are flushed and recessed. Features a .25 watt LED. Measure 1-1/2" in diameter and requires 1" rough opening. Light color - 2600K.

- Item # 52504000 - Gloss Black
- Item # 52504006 - Antique Bronze (shown)
- Item # 52504001 - White
- Item # 52504008 - Black Sand (Textured)



Available in:  
 Black  
 Ant. Bronze

## Endurance Light

Sold in any quantity.

7/8" recessed round 4 L.E.D. 1 watt light with prism lens is designed to fit snugly into 3/4" hole and illuminates a 2' area and includes a 12" pigtail. May be powered with an AC or DC output transformer. Measures 1-1/8" in diameter. Light color - 3000K.

- Item #: HP777RPCB27K - Midnight Black (Textured)
- Item #: HP777RMBR27K - Antique Bronze (shown)



- Available in:
- Hammered White
  - Antique Black
  - Oil Rubbed Bronze
  - Dark Copper Vein



## Millennium - Recessed Outdoor Light Kit

Sold as a kit.

This kit contains everything you need for an outdoor lighting project, kit includes 8 down lights, transformer that handles up to 20 lights, outdoor rated wire nuts, forstner drill bit, and instructions. Lights draw 1.2 watts each. Light color - 3200K. Features updated lens, Cree® LEDs and a new textured body for plug 'n' play wiring harness.

- Item # RDLKITOUT01 - Hammered White
- Item # RDLKITOUT05 - Antique Black
- Item # RDLKITOUT07 - Oil Rubbed Bronze
- Item # RDLKITOUT10 - Dark Copper Vein



Plug and Play Connectors



- Available in:
- Hammered White
  - Antique Black
  - Oil Rubbed Bronze
  - Dark Copper Vein



## Millennium - Recessed Light - 4 Pack

Sold in 4 Pack.

Powder coated low voltage down lights cast a ray of light down or up from the lamp and are perfect for stairs, floors, patios, docks etc., must be purchased in packs of 4. Lights draw 1.2 watts each. Light color - 3200K. Features an updated lens, Cree® LED Light and a new textured finish body for plug 'n' play wiring harness.

- Item # RDL401 - Hammered White
- Item # RDL405 - Antique Black
- Item # RDL407 - Oil Rubbed Bronze
- Item # RDL410 - Dark Copper Vein



Plug and Play Connectors



- Available in:
- Hammered White
  - Antique Black
  - Oil Rubbed Bronze
  - Dark Copper Vein



## Millennium - Recessed Outdoor Stair Light kit

Sold as a kit.

This kit contains everything you need for an outdoor lighting project, kit includes 8 recessed stair lights, transformer that handles up to 20 lights, outdoor rated wire nuts, forstner drill bit, and instructions. Lights draw 1.2 watts each. Light color - 3200K. Features updated lens, Cree® LEDs and new textured body for plug 'n' play wiring harness.

- Item # RSLKITOUT01 - Hammered White
- Item # RSLKITOUT05 - Antique Black
- Item # RSLKITOUT07 - Oil Rubbed Bronze
- Item # RSLKITOUT10 - Dark Copper Vein



Plug and Play Connectors



- Available in:
- Hammered White
  - Antique Black
  - Oil Rubbed Bronze
  - Dark Copper Vein



## Millennium - Recessed Stair Light - 4 Pack

Sold in 4 Pack.

Powder coated low voltage stair lights cast a 30 degree ray of light down from the lamp and are perfect for stairways, must be purchased in packs of 4. Lights draw 1.2 watts each. Light color - 3200K. Features an updated lens, Cree® LED Light and a new textured finish body for plug 'n' play wiring harness.

- Item # RSL401 - Hammered White
- Item # RSL405 - Antique Black
- Item # RSL407 - Oil Rubbed Bronze
- Item # RSL410 - Dark Copper Vein



Plug and Play Connectors





Available in:  
 Clear

### 7/8" Round Water Proof Dek Dots

Sold as a kit or 4 pack.

This kit contains everything you need for your outdoor lighting project, kit includes 8 clear acrylic flush lights, sealed transformer that handles up to 20 lights, wire nuts, forstner bit so lights install flush every time, and instructions. Features 1.2 watt Cree® LED Lights. Light color - 3200K.

Item # DEKDOTKIT

Item # DEKDOT4 - 4 pack lights only



Plug and Play Connectors



Available in:  
 Titanium

### Phoenix Series Recessed LED Kit

Sold in any quantity.

Phoenix series recessed LED kit, contains 10 LED lights which draw .34 watts per light, wire, transformer, connectors and on/off remote. Runs up to 20 Phoenix lights. Light color - 3000 - 3500K.

Item #: DLR100TK - 10 LED Kit



Available in:  
 Titanium

### Phoenix Series Recessed LED

Sold in packs of 10.

Phoenix series recessed LED lights which draw .34 watts per light, must use a DC output transformer. Light color - 3000 - 3500K.

Item #: DLRT10PK - 10 pack

Item #: DLRT2PK - 2 pack



- Available in:
- Hammered White
  - Antique Black
  - Oil Rubbed Bronze
  - Dark Copper Vein



## Spot Light

Sold in any quantity.

High output directional light with textured finish used to highlight specific features or landscape. Light draws 9.6 watts and features Cree® LED Lights. Measures 2"W x 24"H. Light color - 3200K.

- Item # \*SPOTLL01 - Hammered White
- Item # SPOTLL05 - Antique Black
- Item # \*SPOTLL07 - Oil Rubbed Bronze
- Item # \*SPOTLL10 - Dark Copper Vein (shown)



Plug and Play Connectors



Included LED Driver



- Available in:
- Hammered White
  - Antique Black
  - Oil Rubbed Bronze
  - Dark Copper Vein



## Empress Light

Sold in any quantity.

Used to illuminate sidewalks and pathways. Light is powder coated with textured finish and draws 9.6 watts. Features Cree® LED Lights. Measures 7-1/2"W x 26"H. Light color - 3200K.

- Item # \*EMPRESSLL01 - Hammered White
- Item # EMPRESSLL05 - Antique Black (shown)
- Item # \*EMPRESSLL07 - Oil Rubbed Bronze
- Item # \*EMPRESSLL10 - Dark Copper Vein



Plug and Play Connectors



- Available in:
- Hammered White
  - Antique Black
  - Oil Rubbed Bronze
  - Dark Copper Vein



## Radiance Landscape Light

Sold in any quantity.

Multi-Purpose radiance light draws 2 watts and is designed for both landscape light use and accent lighting. Light is powder coated with textured finish and draws 1.9 watts. Features Cree® LED Lights. Measures 6-5/8"W x 23"H. Light color - 3200K.

- Item #: \*RADLL01 - Hammered White
- Item #: RADLL05 - Antique Black
- Item #: \*RADLL07 - Oil Rubbed Bronze
- Item #: \*RADLL10 - Dark Copper Vein (shown)



Plug and Play Connectors



- Available in:
- Hammered White
  - Antique Black
  - Oil Rubbed Bronze
  - Dark Copper Vein



## Radiance Multi-Funtion Light

Sold in any quantity.

Most commonly used for stair or wall lighting, this versatile light can be mounted almost anywhere. Light is powder coated with textured finish and draws 1.9 watts. Features Cree® LED Lights. Measures 6-5/8"W x 2"H x 1". Light color - 3200K.

- Item #: RADML01 - Hammered White
- Item #: RADML05 - Antique Black (shown)
- Item #: RADML07 - Oil Rubbed Bronze
- Item #: RADML10 - Dark Copper Vein



Plug and Play Connectors





## Odyssey LED Light Transformer

Sold in any quantity.

12 volt Odyssey series LED DC waterproof transformer with quick connect pigtail.

Item #: ODLDC - 36 watt  
Item #: ODLDC5 - 60 watt



## Accents LED Transformers

Sold in any quantity.

Accents class 2 transformer suitable for wet locations

Item # 52503000 - 30 watt

Accents class 2 **premium** transformer suitable for wet locations with integrated timer, photo cell with 6' lead, remote control and dimmer. (Reference pages 247 - 248 for operating instructions)

Item # 52503001 - Premium 40 watt transformer (Shown)



## EZ Max C Indoor/Outdoor Transformer

Sold in any quantity.

EZMAXC commercial indoor/outdoor Power - 100 Watt DC output transformer provides power to Dekor™ LED lights. Comes with 2 quick connect outputs that can be used together or separately.

Item # EZMAXC - 100 watt



## EZ Remote Dimmer Single Channel Waterproof

Sold in any quantity.

EZ Remote dimmer single channel remote dimmer can be used with EZ transformers. (Reference page 221 for operating instructions)

Item # EZDIMMERWP



## Remote Dimmer

Sold in any quantity.

12 volt waterproof remote control dimmer needed to power on/off and dim for both Odyssey and Phoenix series transformers and lights, requires separate transformer from either the Odyssey or Phoenix series. (Reference pages 242 - 243 for operating instructions)

Item #: DLRTDIMMER



## Photoelectric Timer

Sold in any quantity.

110 volt photoelectric timer with built in photo eye with 1-8 hour timing options. Designed for use with any transformer and has two outputs. Just plug in to outlet and plug transformer into this unit.

Item #: ML1



## ML Series Transformer with Timer

Sold in any quantity.

AC transformer used to power Nova, Saturn, Anello, Corona, Vega and Nebula LED fixtures. Please note these transformers are not for use with any LEDs requiring DC output.

Add together total bulb wattages to determine transformer size  
**(For use with incandescent lighting)**

Item #: ML121RT - 121 watt transformer  
Item #: ML200RT - 200 watt transformer  
Item #: ML300TW - 300 watt transformer  
Item #: ML600TW - 600 watt transformer



## Heavy Duty Outdoor Low Voltage Wire

Sold in any quantity.

Heavy duty low voltage wire, rated for direct burial and also used for perimeter wiring. Please note 12-2 gauge required for incandescent bulb applications or longer runs of LED lighting. 18-2 gauge is recommended for led lighting applications.

Item #: LVW122100 - 100' length 12 gauge  
Item #: LVW122250 - 250' length 12 gauge  
Item #: LVW182100 - 100' length 18 gauge  
Item #: LVW182250 - 250' length 18 gauge



## Self Piercing Quick Connect Pigtail

Sold in any quantity.

60" self piercing quick connect pigtail for low voltage lighting. Works best with 12 gauge wire.

Item #: DLE-4400 - 12" length  
Item #: DLE-4410 - 60" length  
Item #: DLE-4420 - 96" length

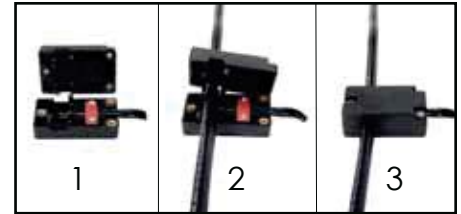

## EZ Quick Connect Replacement Leads

Sold in any quantity.

Replacement pigtail, used on outlet side of EZ and ODL series transformers.

Item #: PIGTAIL



## EZ Quick Connect Splitter

Sold in any quantity.

Attaches to output side of EZ series transformer or dimmer and allows an additional output in the case you would choose to dim a portion of your lighting project independently.

Item #: EZSPLIT



## EZ Quick Connect 5-Way Splitter

Sold in any quantity.

Allows your circuit down stream of transformer or dimmer to be split into 5 separate segments.

Item #: GANGLIGHTTRANSPLITTER





## Phoenix Series LED 22 Gauge Wire

Sold in any quantity.

Phoenix series 22 gauge wire, 100' - 22 gauge twin lead (22-2) wire suitable for use with the Phoenix LED Lights only.

Item #: DLRWIRE



## Phoenix All In One Step Drill

Sold in any quantity.

Phoenix series all-in-one step drill bit cuts hole for light body and recess for bezel for a flush mount.

Item #: DLRBIT



## Forstner Bit

Sold in any quantity.

Forstner bit for Dekor and Fortress Installations.

Item #: 52501040 - 1" Forstner Bit (Fortress™)

Item #: DKRFB - .900" (23mm) Forstner Bit (Dekor™) (Shown)

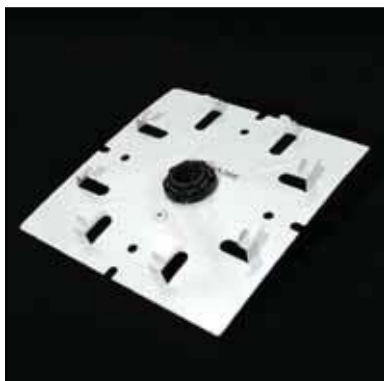

## Replacement Parts - Base plate with Socket

Sold in any quantity.

Base plate with socket, used to convert 12 volt lights to 110 volt lights.

Item #: EBPW110V - for 3-5/8" to 5-1/8" base lights

Item #: \*EBPW66110V - for 5-5/8" to 6-1/8" base lights

Base plate with socket, used to convert 110 volt lights to 12volt lights.

Item #: EBPW12V - for 3-5/8" to 5-1/8" base lights

Item #: \*EBPW6612V - for 5-5/8" to 6-1/8" base lights



## LED Replacement bulb

Sold in any quantity.

LED replacement light bulb converts any bayonet mount low voltage lights with incandescent bulbs to LED. Can be used with AC output transformers.

Item #: LED40 - Cool white, draws approximately 1 watt per bulb  
Item #: LED20 - Warm white, draws approximately 1 watt per bulb



## Replacement L.E.D. Light Bar for Rondi Cap

Sold in any quantity.

Replacement light bars for Dekor™ Rondi post caps. Draws approximately 1/2 watt per bar. Features Cree® LED Lights.

Item #: PCLRSMDCONN - 4 bulb L.E.D. replacement light bar w/ adhesive backing  
Item #: PCRSMDCONN - 6 bulb L.E.D. replacement light bar w/ adhesive backing

 Plug and Play Connectors



## Replacement Diffuser Discs

Sold in any quantity.

Snap in replacement diffuser disk must be used with Millennium recessed lights.

Item # RSLDDSNAP



## Gel Filled Wire Nuts

10 / pack.

10 pack gel filled wire nuts with 2 to 5, 18 gauge wire capacity. Aqua/Orange.

Item # WNSMGF



## EZ Quick Connect to Plug and Play Cable

Sold in any quantity.

20' EZ quick connect to plug and play cable provides a water tight connection from your EZ series transformer or dimmer to your first plug and play 6 port hub/splitter.

Item #: EZPNP20TRANSCONN



Plug and Play Connectors



## EZ Plug and Play Cables

Sold in any quantity.

EZ plug and play cables come in a variety of lengths and are water tight with male fittings on each end. Use these cables to run between plug and play 6 port hubs/splitters.

- Item # EZPNP5CABLE - 5' Cable
- Item # EZPNP10CABLE - 10' Cable
- Item # EZPNP20CABLE - 20' Cable
- Item # EZPNP40CABLE - 40' Cable
- Item # EZPNP60CABLE - 60' Cable



Plug and Play Connectors



## EZ Plug and Play Splice

Sold in any quantity.

EZ plug n play female to female splice connector is designed to connector EZ plug n play cables together. Allows for longer runs of cable to be made.

Item # EZPLUGNPLAYFTOFCONN



Plug and Play Connectors



## EZ Plug and Play 6 Port Splitter

Sold in any quantity.

EZ plug and play 6 port hub/splitter has all female connectors which accept the male ends of the EZ plug and play cables. Includes dummy plugs for unused ports.

Item #: EZPNPSPLITTER



Plug and Play Connectors



### Sirius Tall Pyramid - Black

Sold in any quantity.

Aluminum tall pyramid with frosted glass and 1 ea. 18 watt bulb (included), upgrade to an LED fixture by purchasing and **LED40** or **LED20** bulb sold separately. Light color - 2700K.

- Item #: DLA-6058 - 3-5/8" X 3-5/8"
- Item #: RLA-6058 - 4-1/16" X 4-1/16"
- Item #: DLA-8058 - 5-9/16" X 5-9/16" (+)

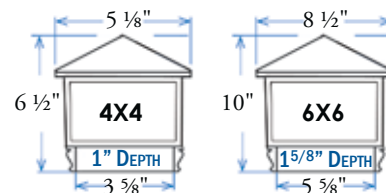

THIS CAP MAY BE USED ON MORE POST SIZES BY CHANGING THE BASE, PLEASE SEE PAGE 181 FOR MORE OPTIONS  
(+) 5-9/16 light contains 3 ea. 18 watt bulbs for a total of 54 watts per fixture



### Titan Tall Flat Top - Black

Sold in any quantity.

Aluminum flat top with ribbed glass and 1 ea. 18 watt bulb (included), upgrade to an LED fixture by purchasing and **LED40** or **LED20** bulb sold separately. ML series transformers recommended for this light. Light color - 2700K.

- Item #: DLA-6048 - 3-5/8" X 3-5/8"
- Item #: RLA-6048 - 4-1/16" X 4-1/16"
- Item #: CLA-6048 - 4-3/8" X 4-3/8"
- Item #: TLA-6048 - 4-5/8" X 4-5/8"
- Item #: \*FLA-6048 - 5-1/16" X 5-1/16"
- Item #: DLA-8048 - 5-5/8" X 5-5/8" (+)

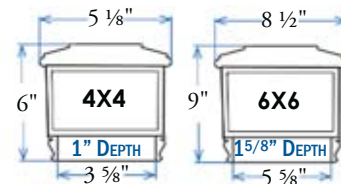

THIS CAP MAY BE USED ON MORE POST SIZES BY CHANGING THE BASE, PLEASE SEE PAGE 181 FOR MORE OPTIONS  
(+) 5-9/16 light contains 3 ea. 18 watt bulbs for a total of 54 watts per fixture



### Orion Tall Flat Top - Black

Sold in any quantity.

Aluminum flat top with ribbed glass and 1 ea. 18 watt bulb (included), upgrade to an LED fixture by purchasing and **LED40** or **LED20** bulb sold separately. ML series transformers recommended for this light. Light color - 2700K.

- Item #: DLA-6068 - 3-5/8" X 3-5/8"
- Item #: RLA-6068 - 4-1/16" X 4-1/16"
- Item #: FLA-6068 - 5-1/8" X 5-1/8"
- Item #: DLA-8068 - 5-5/8" X 5-5/8" (+)

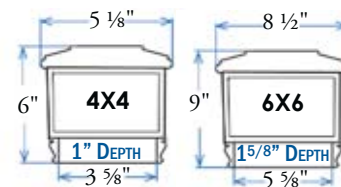

THIS CAP MAY BE USED ON MORE POST SIZES BY CHANGING THE BASE, PLEASE SEE PAGE 181 FOR MORE OPTIONS  
(+) 5-9/16 light contains 3 ea. 18 watt bulbs for a total of 54 watts per fixture



### Sirius Tall Pyramid - Bronze

Sold in any quantity.

Aluminum tall pyramid with frosted glass and 1 ea. 18 watt bulb (included), upgrade to an LED fixture by purchasing and **LED40** or **LED20** bulb sold separately. ML series transformers recommended for this light. Light color - 2700K.

- Item #: DLA-6055 - 3-5/8" X 3-5/8"

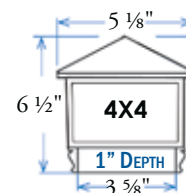

THIS CAP MAY BE USED ON MORE POST SIZES BY CHANGING THE BASE, PLEASE SEE PAGE 181 FOR MORE OPTIONS



### Titan Tall Flat Top - Bronze

Sold in any quantity.

Aluminum flat top with ribbed glass and 1 ea. 18 watt bulb (included), upgrade to an LED fixture by purchasing and **LED40** or **LED20** bulb sold separately. ML series transformers recommended for this light. Light color - 2700K.

- Item #: **DLA-6045** - 3-5/8" X 3-5/8"
- Item #: **RLA-6045** - 4-1/16" X 4-1/16"
- Item #: **\*CLA-6045** - 4-3/8" X 4-3/8"
- Item #: **TLA-6045** - 4-5/8" X 4-5/8"
- Item #: **DLA-8045** - 5-5/8" X 5-5/8" (+)

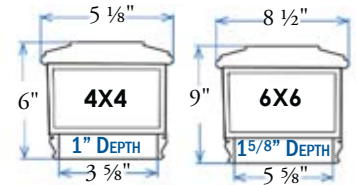

THIS CAP MAY BE USED ON MORE POST SIZES BY CHANGING THE BASE, PLEASE SEE PAGE 181 FOR MORE OPTIONS  
(+) 5-9/16 light contains 3 ea. 18 watt bulbs for a total of 54 watts per fixture



### Orion Tall Flat Top - Bronze

Sold in any quantity.

Aluminum flat top with ribbed glass and 1 ea. 18 watt bulb (included), upgrade to an LED fixture by purchasing and **LED40** or **LED20** bulb sold separately. ML series transformers recommended for this light. Light color - 2700K.

- Item #: **DLA-6065** - 3-5/8" X 3-5/8"
- Item #: **\*DLA-8065** - 5-5/8" X 5-5/8" (+)

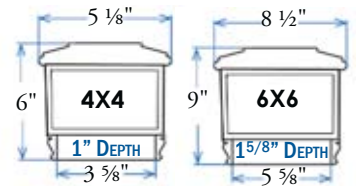

THIS CAP MAY BE USED ON MORE POST SIZES BY CHANGING THE BASE, PLEASE SEE PAGE 181 FOR MORE OPTIONS  
(+) 5-9/16 light contains 3 ea. 18 watt bulbs for a total of 54 watts per fixture



### Sirius Tall Pyramid - White

Sold in any quantity.

Aluminum tall pyramid with frosted glass and 1 ea. 18 watt bulb (included), upgrade to an LED fixture by purchasing and **LED40** or **LED20** bulb sold separately. ML series transformers recommended for this light. Light color - 2700K.

- Item #: **DLA-6050** - 3-5/8" X 3-5/8"
- Item #: **RLA-6050** - 4-1/16" X 4-1/16"
- Item #: **\*FLA-6050** - 5-1/8" X 5-1/8"
- Item #: **\*DLA-8050** - 5-5/8" X 5-5/8" (+)

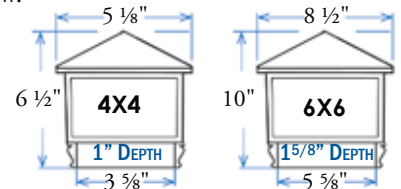

THIS CAP MAY BE USED ON MORE POST SIZES BY CHANGING THE BASE, PLEASE SEE PAGE 181 FOR MORE OPTIONS  
(+) 5-9/16 light contains 3 ea. 18 watt bulbs for a total of 54 watts per fixture



### Titan Tall Flat Top - White

Sold in any quantity.

Tall flat top with ribbed glass and 1 ea. 18 watt bulb (included), upgrade to an LED fixture by purchasing and **LED40** or **LED20** bulb sold separately. ML series transformers recommended for this light. Light color - 2700K.

- Item #: **DLA-6040** - 3-5/8" X 3-5/8"
- Item #: **RLA-6040** - 4-1/16" X 4-1/16"
- Item #: **\*CLA-6040** - 4-3/8" X 4-3/8"
- Item #: **TLA-6040** - 4-5/8" X 4-5/8"
- Item #: **\*FLA-6040** - 5-1/8" X 5-1/8"
- Item #: **\*DLA-8040** - 5-5/8" X 5-5/8" (+)
- Item #: **\*GLA-8040** - 6-1/16" X 6-1/16" (+)

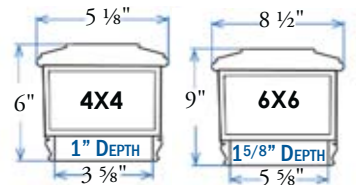

THIS CAP MAY BE USED ON MORE POST SIZES BY CHANGING THE BASE, PLEASE SEE PAGE 181 FOR MORE OPTIONS  
(+) 5-9/16 light contains 3 ea. 18 watt bulbs for a total of 54 watts per fixture



## Orion Tall Flat Top - White

Sold in any quantity.

Orion tall flat top with ribbed glass and 1 ea. 18 watt bulb (included), upgrade to an LED fixture by purchasing and **LED40** or **LED20** bulb sold separately. ML series transformers recommended for this light. Light color - 2700K.

- Item #: **DLA-6060** - 3-5/8" X 3-5/8"
- Item #: **RLA-6060** - 4-1/16" X 4-1/16"
- Item #: **\*FLA-6060** - 5-1/8" X 5-1/8"
- Item #: **\*DLA-8060** - 5-9/16" X 5-9/16" (+)

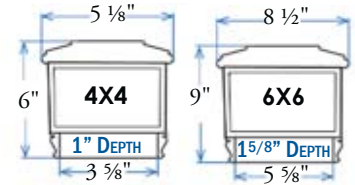

**THIS CAP MAY BE USED ON MORE POST SIZES BY CHANGING THE BASE, PLEASE SEE PAGE 181 FOR MORE OPTIONS**  
(+) 5-9/16 light contains 3 ea. 18 watt bulbs for a total of 54 watts per fixture



## ML Series Transformer with Timer

Sold in any quantity.

AC transformer used to power Nova, Saturn, Anello, Corona, Vega and Nebula LED fixtures. Please note these transformers are not for use with any LEDs requiring DC output.

Add together total bulb wattages to determine transformer size  
**(For use with incandescent lighting)**

- Item #: **ML121RT** - 121 watt transformer
- Item #: **ML200RT** - 200 watt transformer
- Item #: **ML300TW** - 300 watt transformer
- Item #: **ML600TW** - 600 watt transformer



## Heavy Duty Low Voltage Outdoor Wire

Sold in any quantity.

Heavy duty low voltage wire, rated for direct burial and also used for perimeter wiring. Please note 12-2 gauge required for incandescent bulb applications or longer runs of LED lighting. 18-2 gauge is recommended for led lighting applications.

- Item #: **LWV122100** - 100' length 12 gauge
- Item #: **LWV122250** - 250' length 12 gauge
- Item #: **LWV182100** - 100' length 18 gauge
- Item #: **LWV182250** - 250' length 18 gauge



## LED Replacement bulb

Sold in any quantity.

LED replacement light bulb converts any bayonet mount low voltage lights with incandescent bulbs to LED. Can be used with AC output transformers.

- Item #: **LED40** - Cool white, draws approximately 1 watt per bulb
- Item #: **LED20** - Warm white, draws approximately 1 watt per bulb



Available in:

- White
- Bronze
- Black

### Base Converter for 4-1/16"

Sold in any quantity.

Base, converts lights and caps to fit 4-1/16" post. This base converter must be used with 5000 or 6000 series post caps. EX: PCA5068

- Item #: RLAP-6040 - White
- Item #: RLAP-6045 - Bronze
- Item #: RLAP-6048 - Black

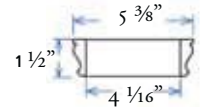

Available in:

- White
- Bronze
- Black

### Base Converter for 4-3/8"

Sold in any quantity.

Base, converts lights and caps to fit 4-3/8" composite posts. This base converter must be used with 5000 or 6000 series post caps. EX: PCA5068

- Item #: CLAP-6040 - White
- Item #: CLAP-6045 - Bronze
- Item #: CLAP-6048 - Black

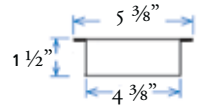

Available in:

- White
- Bronze
- Black

### Base Converter for 4-5/8"

Sold in any quantity.

Base, converts lights and caps to fit 4-5/8" post. This base converter must be used with 5000 or 6000 series post caps. EX: PCA5068

- Item #: TLAP-6040 - White
- Item #: TLAP-6045 - Bronze
- Item #: TLAP-6048 - Black

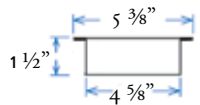

Available in:

- White
- Bronze
- Black

### Base Converter for 5-1/8"

Sold in any quantity.

Base, converts lights and caps to fit 5-1/8" post. This base converter must be used with 5000 or 6000 series post caps. EX: PCA5068

- Item #: FLAP-6040 - White
- Item #: FLAP-6045 - Bronze
- Item #: FLAP-6048 - Black

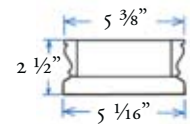

Available in:

- White
- Black

### Base Converter for 6-1/16"

Sold in any quantity.

Base, converts lights and caps to fit 6-1/16" post. To be used **ONLY** with **5-5/8" 8000 Series** post caps and lights.

- Item #: GLAP-8040 - White
- Item #: GLAP-8048 - Black

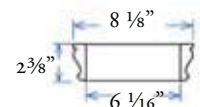

**ADI**<sup>TM</sup>



# SOLAR LIGHTING



**Solar Deck Lighting**

pg 184 - 189



## Pegasus Solar Light - Black

Sold in any quantity.

Aluminum flat top solar light with four LED down lights. (Please note that the base on this light may not be interchangeable with any other sizes). Requires 2 ea. AA rechargeable batteries (included). **Solar panels and batteries are not covered under warranty.** Light color - 7000 - 8000K.

- Item #: SPW-5038 - 3-5/8" X 3-5/8"
- Item #: SPA-6048 - 4-1/16" X 4-1/16"
- Item #: SPC-6048 - 4-3/8" X 4-3/8"
- Item #: SPT-6048 - 4-5/8" X 4-5/8"
- Item #: SPF-6048 - 5-1/8" X 5-1/8"
- Item #: SPW-8048 - 5-1/2" x 5-1/2"

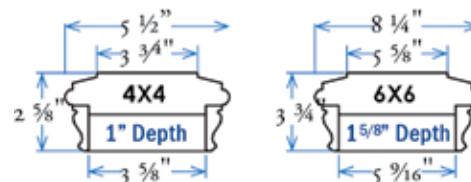

## Imperial Solar Light - Black

Sold in any quantity.

Contemporary, low profile aluminum solar light with illuminated band. Requires 1 ea. Ni-MH rechargeable battery (included). **Solar panels and batteries are not covered under warranty.** Light color - 6500 - 8000K.

- Item #: SL082B - 2" X 2" / 2-1/4" X 2-1/4" / 2-1/2" X 2-1/2"
- Item #: SL211B - 3-5/8" X 3-5/8" / 4" X 4"

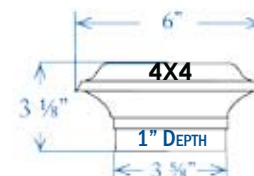

## Fairmont Solar Light - Black

Sold in any quantity.

Made with high quality ABS and real pebbled glass, this light may be mounted on a post or wall. Requires 1 ea. Ni-MH rechargeable battery (included). **Solar panels and batteries are not covered under warranty.** Light color - 8000K.

- Item #: FS100B - 3-5/8" X 3-5/8" / 4" X 4" / 5" X 5"



## Colonial Solar Light - Black

Sold in any quantity.

Made from powder coated cast aluminum and pebbled glass, this cap has two high output LEDs that can stay lit for up to 12 hours. Requires 1 ea. Ni-MH rechargeable battery (included). **Solar panels and batteries are not covered under warranty.** Light color - 7000K.

- Item #: SL088 - 3-5/8" X 3-5/8"

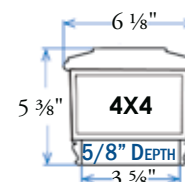



### Polaris Tall Solar Light - Black

Sold in any quantity.

Tall flat top LED aluminum solar lights with ribbed glass panels. Requires 2 ea. AA rechargeable batteries (included). **Solar panels and batteries are not covered under warranty.** Light color - 7000 - 8000K.

- Item #: SLW-6048 - 3-5/8" X 3-5/8"
- Item #: SLA-6048 - 4-1/16" X 4-1/16"
- Item #: \*SLT-6048 - 4-3/8" X 4-3/8"
- Item #: SLF-6048 - 5-1/8" X 5-1/8"
- Item #: SLW-8048 - 5-5/8" X 5-5/8" (+)

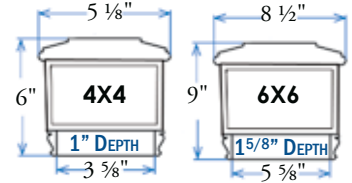

**THIS CAP MAY BE USED ON MORE POST SIZES BY CHANGING THE BASE, PLEASE SEE PAGE 181 FOR MORE OPTIONS (+)5-5/8 version has 4 L.E.D lights**



### Pegasus Solar Light - Bronze

Sold in any quantity.

Aluminum flat top solar light with four LED down lights. (Please note that the base on this light may not be interchangeable with any other sizes). Requires 2 ea. AA rechargeable batteries (included). **Solar panels and batteries are not covered under warranty.** Light color - 7000 - 8000K.

- Item #: SPW-5035 - 3-5/8" X 3-5/8"
- Item #: SPC-6045 - 4-3/8" X 4-3/8"
- Item #: SPT-6045 - 4-5/8" X 4-5/8"
- Item #: SPW-8045 - 5-1/2" x 5-1/2"

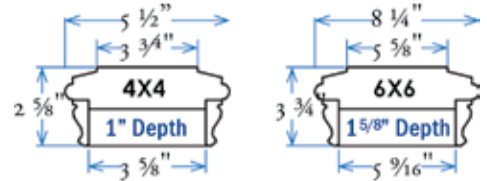

### Imperial Solar Light - Bronze

Sold in any quantity.

Contemporary, low profile aluminum solar light with illuminated band. Requires 1 ea. Ni-MH rechargeable battery (included). **Solar panels and batteries are not covered under warranty.** Light color - 6500 - 8000K.

- Item #: SL211R - 3-5/8" X 3-5/8" / 4" X 4"

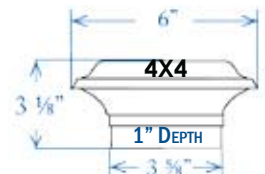

### Polaris Tall Solar Light- Bronze

Sold in any quantity.

Tall flat top LED aluminum solar lights with ribbed glass panels. Requires 2 ea. AA rechargeable batteries (included). **Solar panels and batteries are not covered under warranty.** Light color - 7000 - 8000K.

- Item #: SLW-6045 - 3-5/8" X 3-5/8"
- Item #: SLA-6045 - 4-1/16" X 4-1/16"
- Item #: SLT-6045 - 4-3/8" X 4-3/8"
- Item #: SLW-8045 - 5-5/8" X 5-5/8" (+)

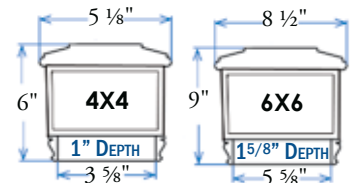

**THIS CAP MAY BE USED ON MORE POST SIZES BY CHANGING THE BASE, PLEASE SEE PAGE 181 FOR MORE OPTIONS (+)5-5/8 version has 4 L.E.D lights**



## Pegasus Solar Light - White

Sold in any quantity.

Aluminum flat top solar light with four LED down lights. (Please note that the base on this light may not be interchangeable with any other sizes). Requires 2 ea. AA rechargeable batteries (included). **Solar panels and batteries are not covered under warranty.** Light color - 7000 - 8000K.

- Item #: SPW-5030 - 3-5/8" X 3-5/8"
- Item #: SPA-6040 - 4-1/16" X 4-1/16"
- Item #: SPC-6040 - 4-3/8" X 4-3/8"
- Item #: SPT-6040 - 4-5/8" X 4-5/8"
- Item #: SPF-6040 - 5-1/8" X 5-1/8"
- Item #: SPW-8040 - 5-1/2" x 5-1/2"

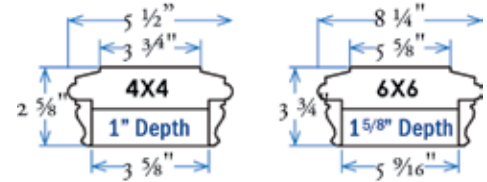

## Imperial Solar Light - White

Sold in any quantity.

Contemporary, low profile aluminum solar light with illuminated band. Requires 1 ea. Ni-MH rechargeable battery (included). **Solar panels and batteries are not covered under warranty.** Light color - 6500 - 8000K.

- Item #: SL211W - 3-5/8" X 3-5/8" / 4" X 4"
- Item #: SL214W - 5" X 5"

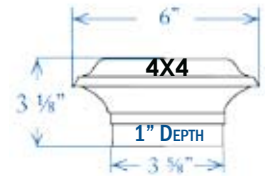

## Regal Solar Light - White

Sold in any quantity.

4"x4" solar light made from PVC and includes 4 surface mount LEDs. Designed to cascade light down the outside walls of the cap and surrounding area. Requires 2 ea. Ni-MH rechargeable batteries (included). **Solar panels and batteries are not covered under warranty.** Light color - 9000K.

- Item #: SL078W - 4" X 4"

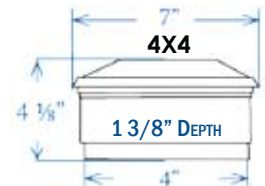

## Majestic Solar Light - White

Sold in any quantity.

5"x5" solar light made from PVC and includes 4 surface mount LEDs. Designed to cascade light down the outside walls of the cap and surrounding area. Requires 2 ea. Ni-MH rechargeable batteries (included). **Solar panels and batteries are not covered under warranty.** Light color - 9000K.

- Item #: SL075W - 5" X 5"

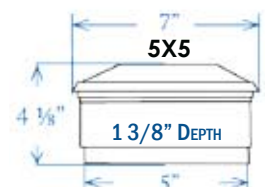



### Fairmont Solar Light - White

Sold in any quantity.

Made with high quality ABS and real pebbled glass, this light may be mounted on a post or wall. Requires 1 ea. Ni-MH rechargeable battery (included). **Solar panels and batteries are not covered under warranty.** Light color - 8000K.

Item #: FS100W - 3-5/8" X 3 5/8" / 4" X 4" / 5" X 5"

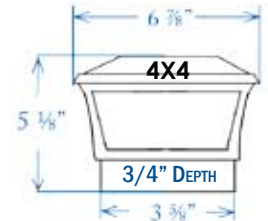

### Prestige Solar Light - White

Sold in any quantity.

Made from white PVC, this light offers a unique design and high output LEDs. Requires 2 ea. Ni-MH rechargeable batteries (included). **Solar panels and batteries are not covered under warranty.** Light color - 7500 - 9000K.

Item #: SL079W - 3-5/8" X 3-5/8" / 4" X 4"  
Item #: SL085W - 5" X 5"



### Ambience Solar Light - White

Sold in any quantity.

This stylized solar light has two unique LEDs that provide a warm yellow flickering light that is similar to real candle light. Requires 2 ea. Ni-MH rechargeable batteries (included). **Solar panels and batteries are not covered under warranty.** Light color - 6500K.

Item #: SL092 - 5" X 5"

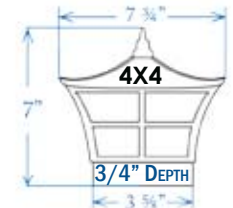

### Classy Solar Light - White

Sold in any quantity.

Made from white PVC, this solar light has 4 high output LEDs that cast light downward onto the sides of the cap and surrounding area. Requires 2 ea. Ni-MH rechargeable batteries (included). **Solar panels and batteries are not covered under warranty.** Light color - 9000K.

Item #: SL074W - 5" X 5"

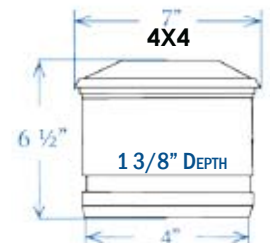



## Polaris Tall Solar Light- White

Sold in any quantity.

Tall flat top LED aluminum solar lights with ribbed glass panels. Requires 2 ea. AA rechargeable batteries (included). **Solar panels and batteries are not covered under warranty.** Light color - 7000 - 8000K.

- Item #: SLW-6040 - 3-5/8" X 3-5/8"
- Item #: SLA-6040 - 4-1/16" X 4-1/16"
- Item #: SLT-6040 - 4-5/8" X 4-5/8"
- Item #: SLF-6040 - 5-1/16" X 5-1/16"
- Item #: SLW-8040 - 5-5/8" X 5-5/8" (+)

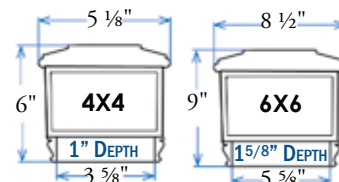

THIS CAP MAY BE USED ON MORE POST SIZES BY CHANGING THE BASE, PLEASE SEE PAGE 181 FOR MORE OPTIONS  
(+)5 5/8 version has 4 L.E.D lights



## Prestige Solar Light - Copper

Sold in any quantity.

Made from electroplated copper, this light offers a unique design and high output LEDs. Requires 2 ea. Ni-MH rechargeable batteries (included). **Solar panels and batteries are not covered under warranty.** Light color - 7500 - 9000K.

- Item #: SL079C - 3-5/8" X 3-5/8" / 4" X 4"
- Item #: SL086 - 5-5/8" X 5-5/8"

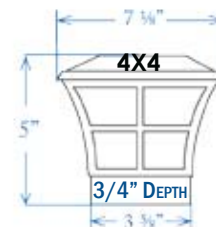

## Ambience Solar Light - Copper

Sold in any quantity.

This stylized solar light has two unique LEDs that provide a warm yellow flickering light that is similar to real candle light. Requires 2 ea. Ni-MH rechargeable batteries (included). **Solar panels and batteries are not covered under warranty.** Light color - 6500K.

- Item #: SL094 - 3-5/8" X 3-5/8" / 4" X 4"

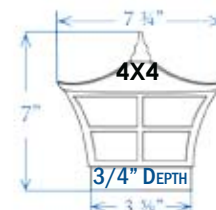

## Deck and Wall Solar Light - Black

Sold in any quantity.

Innovative solar light creates a soft light to accent decks, stairways, patios and gardens. Installs with two screws to the side of a post or any flat surface. Requires 2 ea. Ni-MH rechargeable batteries (included). **Solar panels and batteries are not covered under warranty.** Light color - 7000K.

- Item #: SL178





## Deck and Wall Solar Light - White

Sold in any quantity.

Innovative solar light creates a soft light to accent decks, stairways, patios and gardens. Installs with two screws to the side of a post or any flat surface. Requires 2 ea. Ni-MH rechargeable batteries (included). **Solar panels and batteries are not covered under warranty.** Light color - 7000K.

Item #: SL179

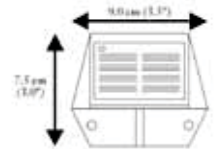

## Deck and Wall Solar Light - Copper

Sold in any quantity.

Innovative solar light creates a soft light to accent decks, stairways, patios and gardens. Installs with two screws to the side of a post or any flat surface. Requires 2 ea. Ni-MH rechargeable batteries (included). **Solar panels and batteries are not covered under warranty.** Light color - 7000K.

Item #: SL177

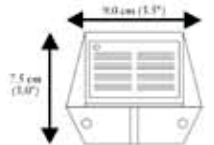

**ADI**<sup>TM</sup>



# ALUMINUM DECKING



## Aluminum Decking

pg 192 - 196

Aluminum decking is manufactured to order. Please allow 3-4 weeks for delivery of product. Freight will be quoted per order and no returns.

**ACTUAL FREIGHT CHARGES APPLY TO ALL ALUMINUM DECKING ORDERS**



Available in:

Woodgrain  
&  
Solid Colors



## Series 100 Aluminum Deck Planking

Sold in any quantity.

Series 100 all aluminum tongue and groove deck planking with durable powder coat finish and limited life time warranty. Planks are available in 2' increments from 12' to 20' with 9 standard colors and 7 wood grain colors. Reference page 195 for color chart.

### Solid Color:

- 12' Item # \*LD100P12SOLIDCOLOR + Color
- 14' Item # \*LD100P14SOLIDCOLOR + Color
- 16' Item # \*LD100P16SOLIDCOLOR + Color
- 18' Item # \*LD100P18SOLIDCOLOR + Color
- 20' Item # \*LD100P20SOLIDCOLOR + Color

### Woodgrain:

- 12' Item # \*LD100P12WOODGRAIN + Color
- 14' Item # \*LD100P14WOODGRAIN + Color
- 16' Item # \*LD100P16WOODGRAIN + Color
- 18' Item # \*LD100P18WOODGRAIN + Color
- 20' Item # \*LD100P20WOODGRAIN + Color

### Please note:

Aluminum decking is manufactured to order. Please allow 3-4 weeks for delivery of product. Freight will be assessed per order and no returns.



Available in:

Woodgrain  
&  
Solid Colors



## Series 200 Aluminum Deck Planking (Watertight)

Sold in any quantity.

Series 200 watertight all aluminum tongue and groove deck planking with durable powder coat finish and limited life time warranty. Planks are available in 2' increments from 12' to 24' with 9 standard colors and 7 wood grain colors. Reference page 195 for color chart.

### Solid Color:

- 12' Item # \*LD200P12SOLIDCOLOR + Color
- 14' Item # \*LD200P14SOLIDCOLOR + Color
- 16' Item # \*LD200P16SOLIDCOLOR + Color
- 18' Item # \*LD200P18SOLIDCOLOR + Color
- 20' Item # \*LD200P20SOLIDCOLOR + Color
- 22' Item # \*LD200P22SOLIDCOLOR + Color
- 24' Item # \*LD200P24SOLIDCOLOR + Color

### Woodgrain:

- 12' Item # \*LD200P12WOODGRAIN + Color
- 14' Item # \*LD200P14WOODGRAIN + Color
- 16' Item # \*LD200P16WOODGRAIN + Color
- 18' Item # \*LD200P18WOODGRAIN + Color
- 20' Item # \*LD200P20WOODGRAIN + Color
- 22' Item # \*LD200P22WOODGRAIN + Color
- 24' Item # \*LD200P24WOODGRAIN + Color

### Please note:

Aluminum decking is manufactured to order. Please allow 3-4 weeks for delivery of product. Freight will be assessed per order and no returns.

**ACTUAL FREIGHT CHARGES APPLY TO ALL ALUMINUM DECKING ORDERS**



**Series 100 Starter Piece**

Sold in any quantity.

Starter piece needed as the first piece in most installations, made of high quality powder coated aluminum. *Please note series when ordering*

**Solid Color 100 Series:**

- 12' Item # \*LD100S12SOLIDCOLOR + Color
- 14' Item # \*LD100S14SOLIDCOLOR + Color
- 16' Item # \*LD100S16SOLIDCOLOR + Color
- 18' Item # \*LD100S18SOLIDCOLOR + Color
- 20' Item # \*LD100S20SOLIDCOLOR + Color

**Woodgrain 100 Series:**

- 12' Item # \*LD100S12WOODGRAIN + Color
- 14' Item # \*LD100S14WOODGRAIN + Color
- 16' Item # \*LD100S16WOODGRAIN + Color
- 18' Item # \*LD100S18WOODGRAIN + Color
- 20' Item # \*LD100S20WOODGRAIN + Color



**Series 200 Starter Piece**

Sold in any quantity.

Starter piece needed as the first piece in most installations, made of high quality powder coated aluminum. *Please note series when ordering*

**Solid Color 200 Series:**

- 12' Item # \*LD200S12SOLIDCOLOR + Color
- 14' Item # \*LD200S14SOLIDCOLOR + Color
- 16' Item # \*LD200S16SOLIDCOLOR + Color
- 18' Item # \*LD200S18SOLIDCOLOR + Color
- 20' Item # \*LD200S20SOLIDCOLOR + Color

**Woodgrain 200 Series:**

- 12' Item # \*LD200S12WOODGRAIN + Color
- 14' Item # \*LD200S14WOODGRAIN + Color
- 16' Item # \*LD200S16WOODGRAIN + Color
- 18' Item # \*LD200S18WOODGRAIN + Color
- 20' Item # \*LD200S20WOODGRAIN + Color



**Edge/Perimeter Trim**

Sold in any quantity.

Edge trim made of high quality powder coated aluminum and works for both the 100 and 200 series deck planks, attaches with color matched stainless steel screws sold separately below.

**Solid Color:**

- 12' Item # \*LDE12SOLIDCOLOR + Color
- 14' Item # \*LDE14SOLIDCOLOR + Color
- 16' Item # \*LDE16SOLIDCOLOR + Color
- 18' Item # \*LDE18SOLIDCOLOR + Color
- 20' Item # \*LDE20SOLIDCOLOR + Color

**Woodgrain Color:**

- 12' Item # \*LDE12WOODGRAIN + Color
- 14' Item # \*LDE14WOODGRAIN + Color
- 16' Item # \*LDE16WOODGRAIN + Color
- 18' Item # \*LDE18WOODGRAIN + Color
- 20' Item # \*LDE20WOODGRAIN + Color



**ACTUAL FREIGHT CHARGES APPLY TO ALL ALUMINUM DECKING ORDERS**



**Marriage/Splice Strip**

Sold in any quantity.

Marriage strip made of high quality powder coated aluminum and works for both the 100 and 200 series deck planks, allows deck boards to be spliced at ends for long runs and attaches with stainless steel screws sold separately below

**Solid Color:**

- 12' Item # \*LDM12SOLIDCOLOR + Color
- 14' Item # \*LDM14SOLIDCOLOR + Color
- 16' Item # \*LDM16SOLIDCOLOR + Color
- 18' Item # \*LDM18SOLIDCOLOR + Color
- 20' Item # \*LDM20SOLIDCOLOR + Color

**Woodgrain Color:**

- 12' Item # \*LDM12WOODGRAIN + Color
- 14' Item # \*LDM14WOODGRAIN + Color
- 16' Item # \*LDM16WOODGRAIN + Color
- 18' Item # \*LDM18WOODGRAIN + Color
- 20' Item # \*LDM20WOODGRAIN + Color

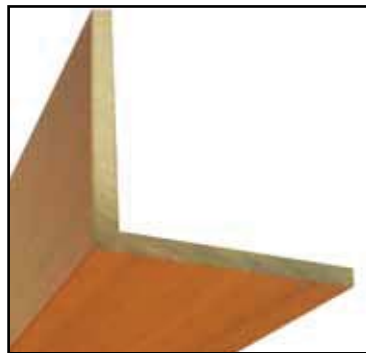

**20' Angle Flashing for 200 series only**

Sold in any quantity.

Angle Flashing powder coated and made exclusively for the 200 series deck plank, comes in 20 foot section only and comes with 11 color matched powder coated stainless steel fasteners

- Item # \*LD200ASOLIDCOLOR + Color
- Item # \*LD200AWOODGRAIN + Color



**Edge Screw**

Sold in any quantity.

5/8" Edge trim self-drilling screw made from stainless steel and powder coated to match.

- Item # \*LDSCR8SOLIDCOLOR + Color
- Item # \*LDSCR8WOODGRAIN + Color



**Deck Screw**

Sold in any quantity.

2" Stainless steel square drive self-drilling deck screw for securing deck planks to joints.

- Item # \*LDSCR10

**ACTUAL FREIGHT CHARGES APPLY TO ALL ALUMINUM DECKING ORDERS**

**Solid Colors**



WHITE : WH



SANDTONE : ST



LIMESTONE : LS



PUTTY : PU

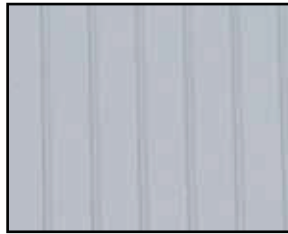

LIGHT GRAY : LG



FROSTED CHARCOAL : FC



CEDAR : CD



BRONZE : CB



REDWOOD : RW

**Woodgrain Colors**



NEVADA OAK - NE

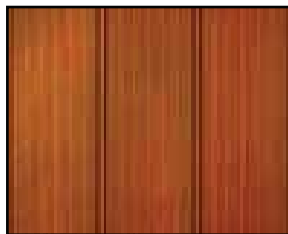

REDWOOD - RE

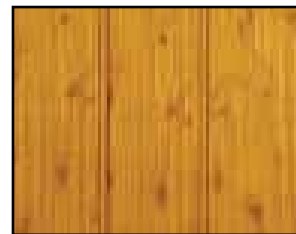

KNOTTY PINE - KN



CHESTNUT - CH

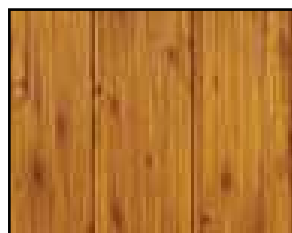

FULL KNOTTY PINE  
FU



MEDITERRANEAN CHERRY  
ME

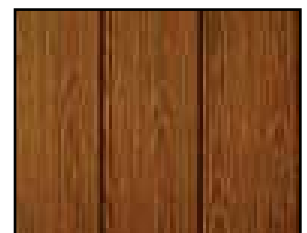

NATURAL OAK - NA

**ACTUAL FREIGHT CHARGES APPLY TO ALL ALUMINUM DECKING ORDERS**



**Solid Color**



**Woodgrain Color**

# DISPLAYS, LITERATURE & SAMPLES



<b>ADI™</b>	pg 198
<b>ADI™ Cable Railing System by Ultra-tec®</b>	pg 199 - 200
<b>AS&amp;D™ Aluminum Railing and Cable System</b>	pg 200 - 201
<b>Solutions™</b>	pg 202 - 203
<b>Titan™</b>	pg 204
<b>Dekor™</b>	pg 205
<b>Fortress™</b>	pg 206 - 207
<b>NextStone™</b>	pg 208
<b>D&amp;D Technologies®</b>	pg 209
<b>Evolve™</b>	pg 209
<b>Aluminum Decking</b>	pg 210
<b>Tehk™</b>	pg 211



**ADI™ Deck Lighting Brochure**  
Item # L00LIGHTINGBROCH2014

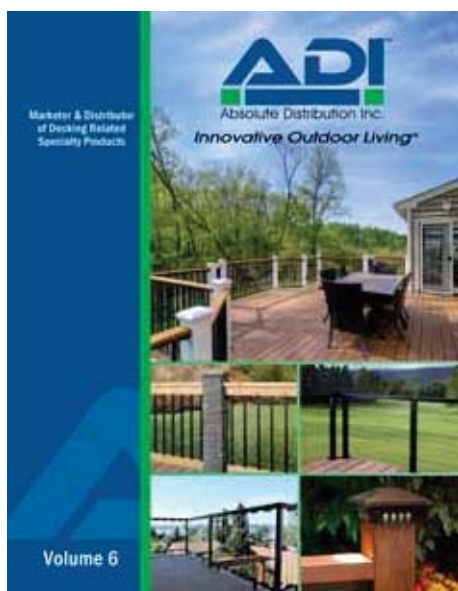

**ADI™ Catalog**  
Item # L00CATALOG14



**ADI™ Lighting Display Tower**  
Item # S00TOTEMDIS



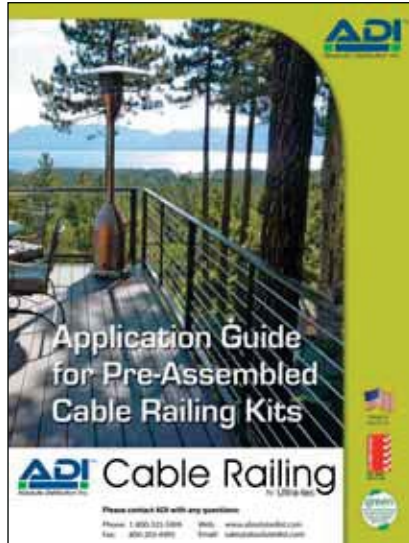

**Cable Railing Application Guide  
Item # S19CABLEAPP**

**Cable Railing Quick-Quote Fax Form  
Item # S19QQFF**



**ADI™ Cable Railing Brochure  
Item # L19CRBROCH2014**



**ADI Cable Railing Counter Display  
Item # S19CRCTDISPLAY**

**Cable Railing Merchandiser**  
Item # **S19CABLERETAILDISP**



**ADI Cable Railing**  
by Ultra-tec



**Cable Rail Counter Top Display**  
Item # **S19CABLECTDISPWOOD**



**AS&D Color Samples**  
Item # **S23ASDCOLORSAMPLES**



**AS&D Aluminum Rail Counter Top Display**  
Item # **S23AS16BLKCTDISPLAY**



**AS&D Aluminum Rail Counter Top Display**  
Item # **S23AS16ANOCTDISPLAY**



**AS&D Aluminum Rail w/ Aluminum Woodgrain Floor Display**  
**Item # S23AS36WALBLKFLOOR**



**AS&D Aluminum w/ Wood Cap Floor Display**  
**Item # S23AS36WOODANOFLOOR**



**AS&D Aluminum Rail Floor Display**  
**Item # S23AS36BLKFLOORDISP**



**AS&D Aluminum Rail Floor Display**  
**Item # S23AS36ANOFLOORDISP**

ALUMINUM  
*Solutions*  
BALUSTERS



**Item #**  
**L01SML004**



**Consumer Literature**  
**Item # L01SML003**



**Solutions Color Sample Box**  
**Item # S01BALUSTERSAMPLES**



**L SHAPE DISPLAY**  
**Item # S01SOLUTIONSLSHAPE**



**BALUSTER CONNECTOR DISPLAY**  
**Item # S01ARCHCONNADDONKIT**



**Solutions Sales Stair Sample**  
Item # S01401932



**Solutions Glass Floor Display**  
Item # S01401936

ALUMINUM  
*Solutions*  
RAIL SYSTEMS

**Consumer Literature**

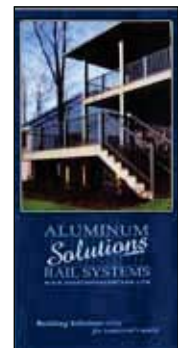

Item # L01SML001

Item # L01SML002



**SOLUTIONS FLOOR DISPLAY**  
Item # S01401930

**Solutions Quick-Quote**  
Fax to 800-203-4495

**Solutions LEVEL Guard Rail Planning Guide**

1. **COLOR**  
White  Black  Bronze  Silver  Please send a sample with dimensions

2. **GUARD RAIL HEIGHT**  
Residential 36"  Commercial 42"

3. **POST TO RAIL CONFIGURATION**  
POST TO POST  OVER THE POST

4. **RAIL STYLE**  
Round  Square  Other

5. **MOUNTING STYLE**  
Surface Mount  Side-Flange Mount

6. **POST TYPE**  
4" Base Over Post to Post  3x4" Flat Base Post to Post  3x4" Ingot Post to Post  3x4" Post Over Post

7. **USE GRID ON BACK TO DRAW GRID ON FLOOR AREA**  
Reference sketch of deck with posts and rail sections. Cover all sections and enter quantities below.

8. **THE NUMBER OF FEET REQUIRED TO COMPLETE PROJECT FROM START TO BACK OF FINISH**  
Cost of railing material is shown by length. For example, 100 feet of railing is shown as 100 feet. Cost of post and post cap is shown by quantity. For example, 100 posts is shown as 100 posts. Cost of railing material is shown by length. For example, 100 feet of railing is shown as 100 feet.

**RAILING SECTIONS**

4' \_\_\_\_\_ 6' \_\_\_\_\_ 8' \_\_\_\_\_

**POSTS AND POST CAPS (REQUIRED)**

Post: \_\_\_\_\_ Post Size: \_\_\_\_\_ Post Mount: \_\_\_\_\_  
Post Top: \_\_\_\_\_ Post Cap: \_\_\_\_\_

**POST TO POST CONNECTOR BRACKETS**

Top Rail Bracket (PP or OPS) (See Separately)

**OVER THE POST CONNECTOR BRACKETS (REQUIRED)**

Top Rail Bracket \_\_\_\_\_ Top Rail Bracket \_\_\_\_\_  
Top Rail Bracket \_\_\_\_\_ Top Rail Bracket \_\_\_\_\_  
Top Rail Bracket \_\_\_\_\_ Top Rail Bracket \_\_\_\_\_

**Solutions Quick-Quote Fax Form**  
Item # S01QQFF



**Titan Merchandiser**  
Item # S03DR262650VIDEO



**Titan™ 4x4 Counter Top Display**  
Item # S03TITAN4X4DISPLAY

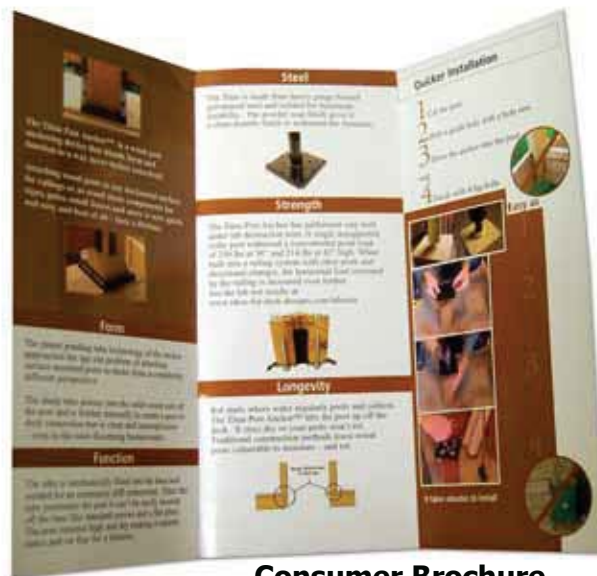

**Consumer Brochure**  
Item # L03TITANTRIFOLD



**Consumer Brochure**  
Item # L06DKBROCH2014



**DEKOR™ Baluster Display**  
Item # SO6DKRDISPLAY2011



**DEKOR™ Color Samples**  
Item # S06DKRCLRCHN



**Fortress Fe26 Counter Top Display**  
Item # S18FE26CTDISPLAY



**Fortress Consumer Brochure**  
Item # L18FORTRESSCONSLIT

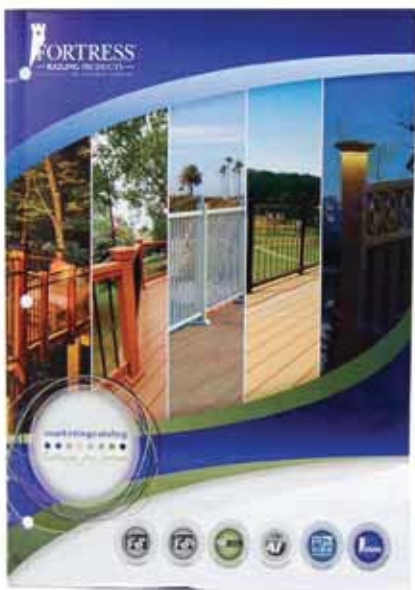

**Fortress Full Line Catalog**  
Item # L18FORTFULLINECAT



**Fortress AL13 Floor Display**  
Item # S18AL13FLRDISPLAY





**Fortress Fe26 Counter Top Baluster Display**  
Item # S18660942



**Fortress Fe26 Hand Sample**  
Item # S18660981



**Fortress Large Showroom Display**  
Item # L18FORTRESSTOWER



**Fortress Fe26 Hand Sample**  
Item # S18660981ABZ



**Fortress AL13 Hand Sample**  
Item # S1851600010



**SlateStone™ Color Samples**  
Item # L25SLSCOLORSAMPLES



**SlateStone™ Post Cover Brochure**  
Item # L25SLSBROCH2014

**SlateStone™ Post Cover Stand-Alone Display**  
Item # SLSPCBB  
Item # SLSPCCBR  
Item # L01DECKLITBROCHHOLD



**SlateStone™ Post Cover Display**  
Item # S25DBLSLSDISPLAY2014



**SlateStone™ Post Cover ADD-ON Display**  
Item # S25PCADDON2014

**D&D Technologies**  
Hi-Performance Hardware



**D&D Tech. Brochure**  
Item # L20DDCONSLIT

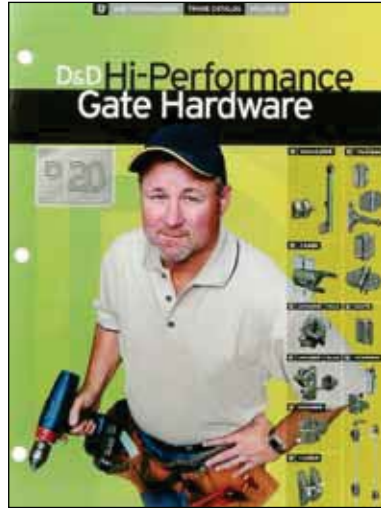

**D&D Tech. Catalog**  
Item # L20DDCATALOG



**D&D Counter Top Display**  
Item # S20DDGATEDISPLAY



**Evolve Consumer Literature**  
Item # L16EVOLVECONSLIT



**Evolve Color Sample**  
Item # S16BALUSTERSAMPLES

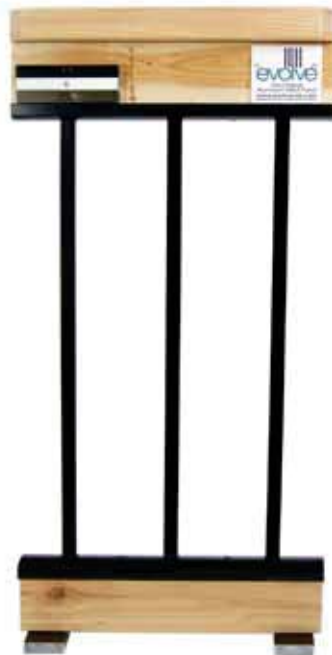

**Evolve Floor Display**  
Item # S16EVOLVEFLRDISP



**Evolve Stair Display**  
Item # S16EVOLVESTRDISP



**Aluminum Decking Walkon Display**  
Item # S12LDWOODDISPLAY



**Aluminum Decking Walkon Display**  
Item # S12LDSTDDISPLAY

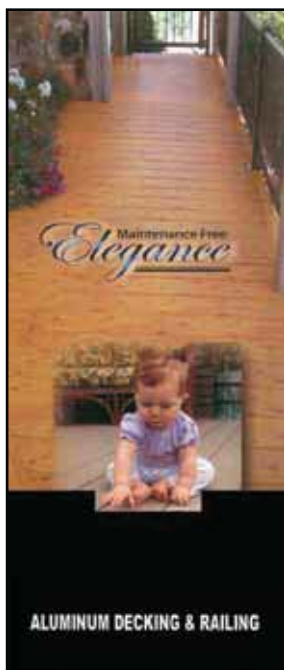

**Aluminum Decking Brochure**  
L12LDBROCURE



**Aluminum Decking Color Samples**  
Item # S12LDWOODCOLOR



**Aluminum Decking Color Samples**  
Item # S12LDSTDCOLOR



**Tehk Color Floor Display**  
**Item # S12TKDISPLAY2011**



**Tehk Consumer Brochure**  
**Item # L12TEHKBROCHURE**

**ADI**<sup>TM</sup>

# INSTALLATION INFORMATION & FAQ'S



<b>Solutions™</b>	pg 214 - 217
<b>Dekor™</b>	pg 218 - 221
<b>ADI™ Cable Railing by Ultra-tec®</b>	pg 222 - 229
<b>Nextstone™</b>	pg 230 - 232
<b>Titan™</b>	pg 233
<b>Aurora™ Deck Lighting</b>	pg 234 - 243
<b>Solutions™ Rail</b>	pg 244- 246
<b>Fortress™ Rail</b>	pg 247- 252
<b>Solution™ and Cable Railing Order Forms</b>	pg 253 - 256

*Solutions*

**3/4" ALUMINUM BALUSTERS**  
LEVEL AND STAIR INSTALLATION GUIDE

**LEVEL**

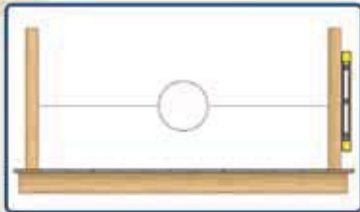

**STEP #1** - Plumb posts/mounting surfaces. Measure inside distance of posts/mounting surfaces.

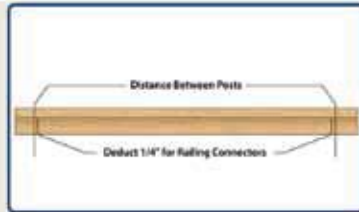

**STEP #2** - Using step - 1 measurement, deduct 1/2" from total measurement for railing connectors (if not using railing connectors, cut to step - 1 measurement). Cut both top and bottom rails.

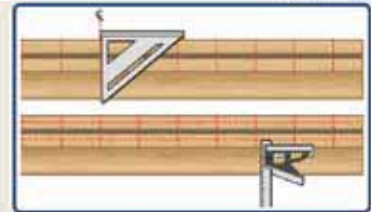

**STEP #3** - Lay top and bottom rails beside each other and flush ends. Find the center of rails and mark **lightly**. Measure out 4-1/2" from both sides of center line and mark **lightly**. End spacing will vary. Set a combination square for center (example: 1-1/2" = 3/4") and mark **lightly**. Where lines intersect will be the center of baluster.

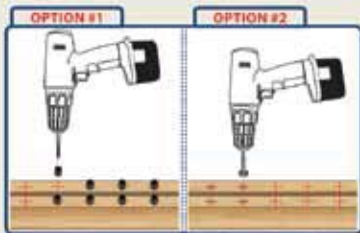

**STEP #4** - There are two options for installing balusters.

**Option #1** - Connector Method: Insert screw through connector and install where lines intersect (you may want to mark the center with a nail before drilling).

**Option #2** - Insert Method: Drill a 3/4" hole, 3/4" deep in top and bottom rails where lines intersect.

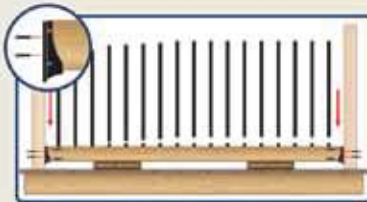

**STEP #5** - Install two (2) #8 x 2" screws (per connector) through railing connector into rail ends. Rest bottom rail on two (2) temporary spacer blocks the required height between deck and bottom of bottom rail. Center railing connectors on post and install four (4) #8 x 2" screws (per connector) through railing connector into posts. Apply a small amount of silicone caulk to diameter of baluster where it meets baluster connector or insertion hole to insure a tight, movement-free installation. Install balusters on bottom rail.

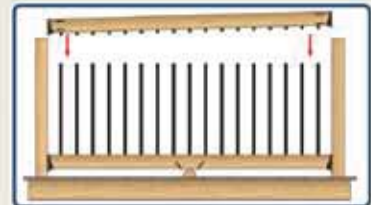

**STEP #6** - Start Top Rail at an angle and insert connectors into balusters or balusters into insertion holes in top rail. Make sure balusters are fully connected. Install four (4) #8 x 2" screws (per connector) through railing connectors into posts.  
NOTE: With spans greater than 6' (or required), install a foot block (use cut-off from rail).

**STAIR**

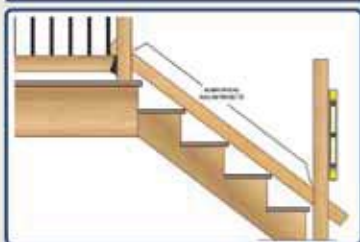

**STEP #1** - Lay bottom rail alongside posts and mark for angle. If posts are plumb top rail should be the same length and angle. Cut top and bottom stair rails at proper angle.

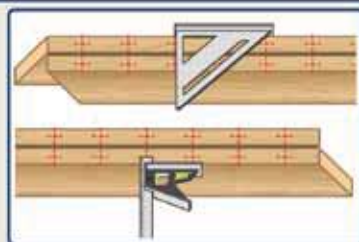

**STEP #2** - Lay top and bottom rails beside each other with the top rail turned upside down. Position rails as shown. Find the center of rails and mark **lightly**. Measure out 5-1/2" from both sides of center line and mark **lightly**. End spacing will vary. Set a combination square for center (example: 1-1/2" = 3/4") and mark **lightly**. Where lines intersect will be center of screw/insertion hole.

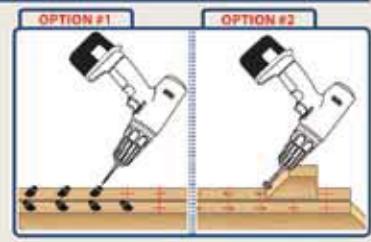

**STEP #3** - There are two options for installing balusters.  
**Option #1** - Connector Method: Insert screw through connector and install where lines intersect (start screw vertically and tilt screw to proper angle). **Top and bottom baluster connectors will be facing opposite directions.** Do not overtighten. **Option #2** - Insert Method: Drill a 3/4" hole, 3/4" deep in top and bottom rails where lines intersect using a rail cut-off as a guide block for stair angle.

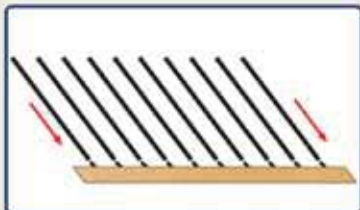

**STEP #4** - Make sure connectors are properly lined up. Apply a small amount of silicone caulk to diameter of baluster where it meets baluster connector or insertion hole to insure a tight, movement-free installation. Install balusters on bottom rail.

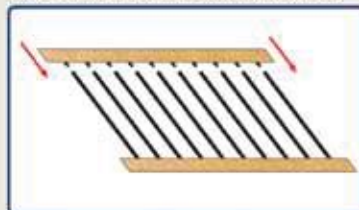

**STEP #5** - Start Top Rail at an angle and insert connectors into balusters or into insertion holes until all balusters are in place. Make sure balusters are fully connected.



**STEP #6** - Install stair rail assembly.

Please Note: Do not exceed a 4" gap between balusters. Gap between deck and bottom rail should not exceed 4". It is the responsibility of the installer to meet or exceed all code and safety requirements, and to obtain all required building permits. These instructions are only a guide and may not address every circumstance. The deck and railing installer should determine and implement appropriate installation techniques for each situation. **Solutions shall not be held liable for improper or unsafe installations.**



*Solutions*

**FACE MOUNT BALUSTERS**  
LEVEL AND STAIR INSTALLATION GUIDE

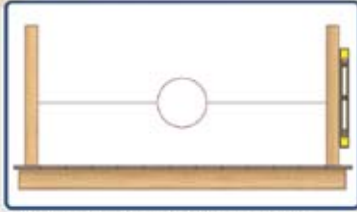

**STEP #1** - Plumb posts/mounting surfaces. Measure inside distance of posts/mounting surfaces.

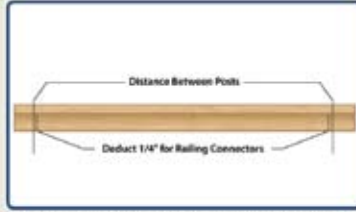

**STEP #2** - Using step - 1 measurement, deduct 1/2" from total measurement for railing connectors (if not using railing connectors, cut to step - 1 measurement). Cut both top and bottom rails.

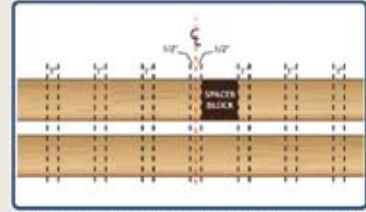

**STEP #3** - Find center of top and bottom rails. From center line, measure and mark 1/2" on both sides of center mark (marking a 1" space). Cut a 3-1/2" spacer block and hold against the outside edge of center 1" space. Repeat process on other side of center and continue across rail. NOTE: 3-1/2" is a "Starting Point" it may be necessary to adjust spacing depending on rail length. Do not exceed 4" gap between balusters.



**STEP #4** - Lay rails on a flat surface & install the two (2) outer balusters (four (4) screws per baluster). This will maintain spacing between rails.

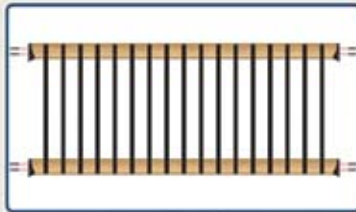

**STEP #5** - Finish installing balusters. Slide railing connectors on rail ends making sure rail is fully seated in connector. Install two (2) #8 x 2" screws (per connector) through railing connectors into rail ends.

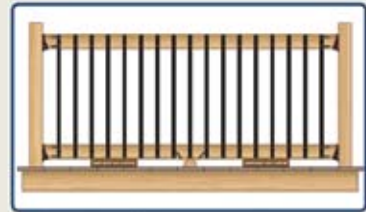

**STEP #6** - Rest rail section on two (2) temporary spacer blocks the required height between deck and bottom of bottom rail. Center railing connectors on post and install four (4) #8 x 2" screws (per connector) through railing connector into posts. NOTE: With spans greater than 6' (or required), install a foot block (use cut-off from rail).

**RAILING CONNECTOR**  
INSTALLATION GUIDE

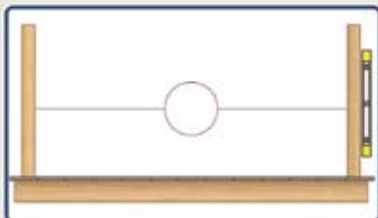

**STEP #1** - Plumb posts/mounting surfaces. Measure inside distance of posts/mounting surfaces.

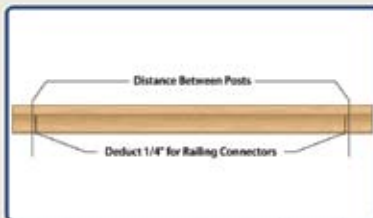

**STEP #2** - Using step - 1 measurement, deduct 1/2" from total measurement for railing connectors. Cut both top and bottom rails.

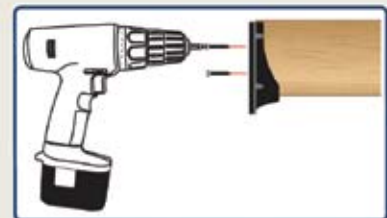

**STEP #3** - Slide railing connectors on rail ends making sure rail is fully seated in connector. Install two (2) #8 x 2" screws (per connector) through railing connectors into rail ends.

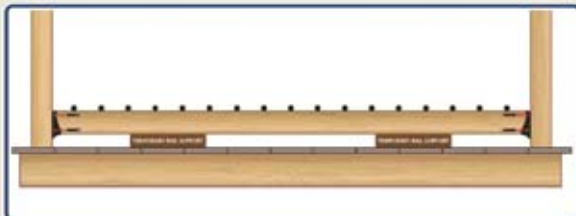

**STEP #4** - Cut two (2) "Spacer Blocks" to be placed between deck & bottom rail. Place bottom rail section between posts. Install four (4) #8 x 2" screws (per connector) through railing connectors into posts

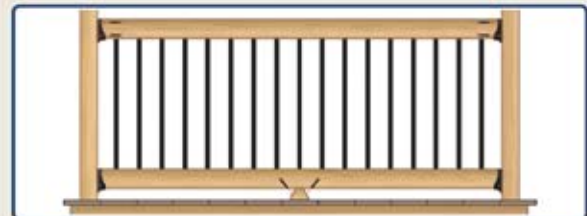

**STEP #5** - Place top rail into position. Install four (4) #8 x 2" screws (per connector) through railing connectors into posts. NOTE: With spans greater than 6' (or required) install a foot block (use cut-off from rail).

Please Note: Do not exceed a 4" gap between balusters. Gap between deck and bottom rail should not exceed 4". It is the responsibility of the installer to meet or exceed all code and safety requirements, and to obtain all required building permits. These instructions are only a guide and may not address every circumstance. The deck and railing installer should determine and implement appropriate installation techniques for each situation. **Solutions shall not be held liable for improper or unsafe installations.**

## GLASS BALUSTERS

### LEVEL AND STAIR INSTALLATION GUIDE

#### LEVEL

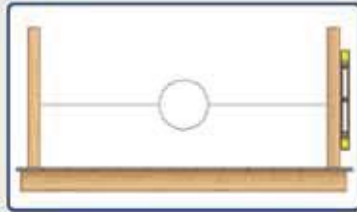

**STEP #1** - Plumb posts/mounting surfaces. Measure inside distance of posts/mounting surfaces.

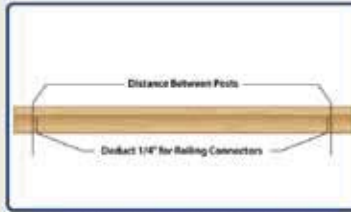

**STEP #2** - Using step - 1 measurement, deduct 1/2" from total measurement for railing connectors (if not using railing connectors, cut to step - 1 measurement). Cut both top and bottom rails.

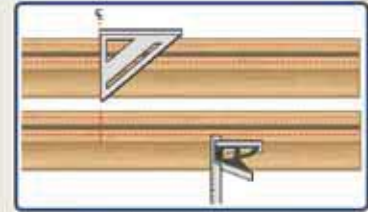

**STEP #3** - Lay top and bottom rails beside each other and flush ends. Find the center of rails and mark **lightly**. From the center mark, measure out 8", from both sides and mark. End spacing will vary. Note: Baluster spacing will vary with rail length.

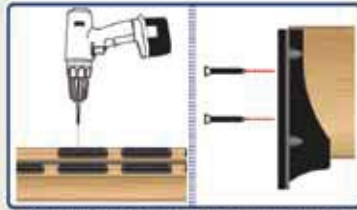

**STEP #4** - With 8" center marks measure over 2-1/2" (this will be the edge of glass baluster connector shoe). Center baluster shoe on rail and insert screws through connector shoe. Make sure screw head is inserted below Glass Baluster. Install two (2) #8 x 2" screws (per connector) through railing connectors into rail ends.



**STEP #5** - Cut two (2) temporary spacer blocks the required distance between deck and bottom of rail. Rest bottom rail on spacer blocks and center on mounting surface. Install four (4) #8 x 2" screws (per connector) through railing connectors into posts. Apply a small amount of silicone caulk to inside of glass baluster connector shoe to insure a tight, movement-free installation. Insert glass balusters into glass baluster connector shoes.

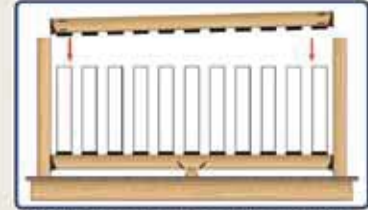

**STEP #6** - Start top rail at an angle and insert balusters into glass baluster connector shoes. Install four (4) #8 x 2" screws (per connector) through railing connectors into posts. NOTE: With spans greater than 6' (or required), install a foot block (use cut-off from rail).

#### STAIR

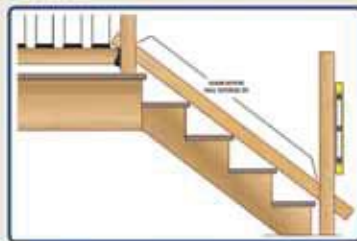

**STEP #1** - Lay bottom rail alongside posts and mark for angle. If posts are plumb top rail should be the same length and angle. Cut top and bottom stair rails at proper angle.

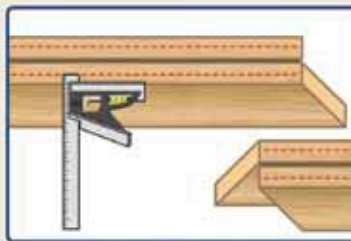

**STEP #2** - Put the two rails together with the top rail turned upside down. Position rails as shown. Lightly mark a center line on rail. Determine number of Glass Balusters and space out evenly. Layout glass baluster connector shoes. Maintain a maximum of 2-3/8" gap between stair glass baluster shoes.

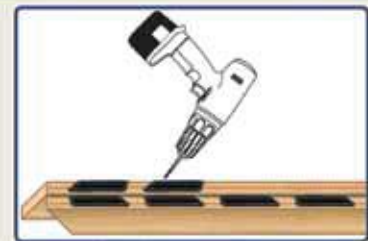

**STEP #3** - Place glass baluster connector shoes on center line. Top and bottom baluster shoes connectors will be facing opposite directions. Insert screws through connector shoes (start screw vertically and tilt screw to proper angle). Do not overtighten. Make sure screw head is inserted below Glass Baluster.

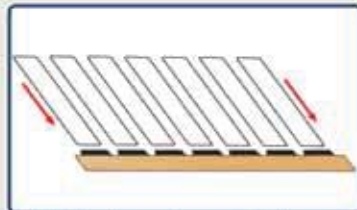

**STEP #4** - Apply a small amount of silicone caulk to inside of glass baluster connector shoe to insure a tight, movement-free installation. Insert balusters in bottom rail connector shoes.

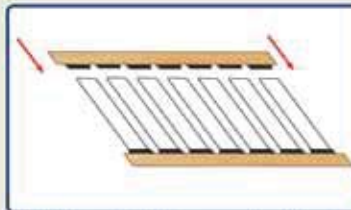

**STEP #5** - Start Top Rail at an angle and insert balusters into top rail connector shoes. Make sure glass balusters are fully inserted into connector shoes.



**STEP #6** - Install stair rail assembly.

Please Note: Do not exceed a 4" gap between balusters. Gap between deck and bottom rail should not exceed 4". It is the responsibility of the installer to meet or exceed all code and safety requirements, and to obtain all required building permits. These instructions are only a guide and may not address every circumstance. The deck and railing installer should determine and implement appropriate installation techniques for each situation. **Solutions shall not be held liable for improper or unsafe installations.**

*Solutions*

## SOLUTIONS BALUSTERS LIMITED LIFETIME WARRANTY

Solutions [The Manufacturer] warrants its Baluster products and Accessories subject to the terms, conditions and limitations listed herein, to be free from defective workmanship and materials, and when subject to normal and proper use, its powder coat finish is further warranted against surface peeling, flaking, or blisters for residential applications.

### SOLUTIONS TERMS, CONDITIONS AND LIMITATIONS

1. The Manufacturer's sole liability and the owner's only remedy shall be as follows:
  - a. If a problem occurs, The Manufacturer, at its sole discretion, may elect either to repair or replace the defective part(s) or provide reimbursement limited to cost of materials at time of purchase. Due to normal aging and weathering of material, it may not be possible to perfectly match the colors of the old and new materials and therefore The Manufacturer is not responsible for any color differences that may occur. The Manufacturer is further not responsible for discontinuance of a specific color or shade.
2. The Manufacturer warrants only those baluster products manufactured and sold under the Solutions name. This Limited Lifetime Warranty extends only to the original purchaser according to terms specified herein. The Manufacturer shall not be liable for and this warranty does not apply to any terms, failure, defect or damage resulting from or connected with the following:
  - a. Defects not caused by The Manufacturer ( for example, but not limited to: accidents, misuse, improper applications or installations contrary to industry or Solutions standards)
  - b. Product that has been painted or had its surface treated or cleaned with other than approved chemicals or exposed to other corrosive environments
  - c. Product subject to impact of foreign objects, tornado, hurricane, other violent storms, fire, air pollutants, normal weathering of surfaces, abnormal discoloration due to improper maintenance, or any other acts of God
  - d. Improper installation of Solutions products or defects caused by their installation
  - e. Solutions Limited Lifetime Warranty will not be applicable for products that are covered by a specific and separate warranty or duration
  - f. Products sold, shipped or installed outside of the Continental United States shall have a limited duration of this coverage to 7 years from date of purchase
  - g. Products that have been damaged by exposure to salt water conditions when installed within 2 miles of salt water oceans
3. This warranty does not include corrosion of screws and other fastening devices that may be used or required in the assembly or installation of the baluster products.
4. Should there be a defect which limits the use of the railings The Manufacturer will not be responsible for or liable for loss of use of the railing or any consequential costs. The Manufacturer's only liability is for the repair or replacement of the defective baluster or accessories covered under warranty.
5. The Manufacturer will not be responsible for labor and material cost including removal, disposal and reinstallation of the warranted material.
6. The Manufacturer will not be required to honor this warranty
  - a. If the balusters or accessory has been modified, altered or changed in any manner at time of installation or thereafter that is contrary to The Manufacturer's installation instructions.
  - b. The product was not installed to the most current, published standards which are available from The Manufacturer.
  - c. A representative has not been given a reasonable access to the property & opportunity to investigate any claim made.
  - d. If all bills for installation supplies and services have not been paid in full. Proof of purchase must be presented to obtain warranty coverage.
  - e. If the Manufacturer's Care and Cleaning Guide have not been adhered to.
  - f. If the Limited Lifetime Warranty has not been registered with The Manufacturer at [www.solutionsrail.com](http://www.solutionsrail.com).
7. Claims made under this warranty must be made within 30 days of the discovery of the problem. The claim must be made in writing, to Solutions Warranty Claim, PO Box 37, Mt. Joy, PA 17552, including detailed claims and must include a copy of the purchase contract/receipt and copy of the original package label. Claims shall be covered as follows:
 

• Warranty Refund Proration:	
Percentage of original purchase price	Years since purchase
100%	1-7
50%	8-10
25%	11 or more
8. To the extent allowed by the laws of each State or Province, the remedies provided under this warranty state the limits of The Manufacturer's responsibility. No representative has authority to make any representations other than those stated herein. Any and all disputes arising under the warranty whether as to interpretation, performance or otherwise, shall be subject to the exclusive jurisdiction of the courts of each State or Province.
9. This warranty is for the exclusive benefit of the original purchaser and is not assignable or transferable.
10. It is the responsibility of the Owner to maintain the balusters and accessories in accordance with the current Care and Cleaning Guide on the reverse and as posted on the website at [www.solutionsrail.com](http://www.solutionsrail.com)
11. This warranty is offered by The Manufacturer. The Manufacturer is responsible for remedy of its affected materials relating to the problem. The undersigned Installation Company is responsible for the workmanship and may facilitate any necessary and related claims and repairs.

The Installation Company may offer an additional written warranty stating the scope of their responsibility.

Installation Company \_\_\_\_\_ Installation Company's telephone \_\_\_\_\_

Installation Company's Address \_\_\_\_\_ Date of Installation \_\_\_\_\_

Building Owner's Name & Address \_\_\_\_\_

Building Address (if different than above) \_\_\_\_\_

Signature – Installation Company Rep. Date \_\_\_\_\_ / \_\_\_\_\_

[www.solutionsrail.com](http://www.solutionsrail.com)

## Installation Guide for Dekor™ Balusters

### Tools required for installation:

- Power Drill Motor
- DEKOR™ Drill Kt (includes Forstner bit and hole template) template is designed to be used with dimensional composite/wood only.  
 Use Forstner bit only, if drill template is not compatible with your rail material
- Rubber Mallet

### If installing Illuminated product, add:

- Router or Table saw to cut channel in top and/or bottom rails
- Pliers
- Wire Strippers
- Screwdriver to attach leads to DEKOR™ power transformer
- DEKOR™ 18 gauge outdoor rated two conductor wire
- DEKOR™ water resistant wire nuts

### Installation of Traditional Rail Kit:

**Note:** Our product is designed to be installed using our custom sized Forstner bit. Using other bits will result in either a loose fit or too tight that will result in damage during installation.

1. Prior to drilling holes in top and bottom rails for the end caps, find center of section. Start with either the top or the bottom rail. The DEKOR™ hole template is designed for dimensional composite/wood, spacing the balusters on 4 5/8" centers required for code compliance. After drilling first hole, slip template into hole and repeat until holes reach end of section. You can reduce the center to center distance to fit your specific rail length but you cannot exceed the 4 5/8" on center spacing.
2. Repeat for other rail.
3. Once holes are drilled, place end caps into holes and tap secure with rubber mallet. Caution: Using a metal hammer or other blunt instrument will damage the powder coating and is not covered under warranty. If installing square balusters, rotating the end cap 90 degrees will change the appearance of your project. Choose which look you desire.
4. Lay bottom rail on flat surface and insert balusters into bottom end caps. Be sure to start at the center with the double basket and then place single baskets on either side. Work out toward ends with plain balusters until all caps are full.
5. Carefully align top rail with end caps and slip onto balusters. Secure top and bottom rails with tie-downs or other method to keep section intact.
6. Carefully lift section into place between posts. We recommend setting section on blocks prior to attaching rails to posts. (See local codes for proper height of bottom rail).
7. Secure rail section to posts.



## Installation of Non- Illuminated Stair Rail

1. Prior to drilling holes in top and bottom rails for the end caps, find center of section. Start with either the top or the bottom rail. Space holes on 6" centers which will give code compliance spacing.
2. Stair fittings are designed to be inserted in Forstner drilled perpendicular holes to rail face. Holes can be drilled with rails in place or resting on a flat surface. A flat surface is preferred so that drilling perpendicular is more easily accomplished and you have the reinforcement of the surface when applying drill pressure. You can reduce the spacing to your specific stair length just don't exceed 6" spacing.
3. Once holes are drilled place stair end caps into holes and tap secure with rubber mallet. Fittings are designed for 35° stair rise but can easily be changed to 33-37° by tapping the fitting in the desired direction allowing the back side knife edge to cut into your rail. To provide additional securing, if desired, the hole in the center of the fitting will accommodate wood screws.
4. Secure bottom rail to posts and insert balusters into bottom stair end caps. Place single basket balusters where desired in rail section.
5. Carefully align top rail with stair end caps in place and slip onto balusters. Secure top rail to post and finish handrail as desired.

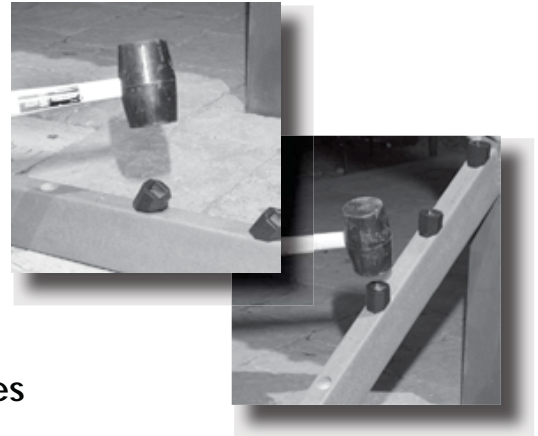
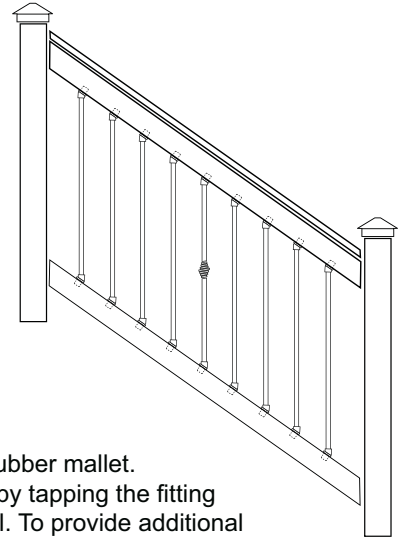

## Led Wiring Guidelines

This document is written to give some general guidelines for the wiring of our product. We realize that each and every installation will have its own idiosyncrasies that will require your creativity and adaptability to the guidelines listed below.

### LED's:

At DEKOR, we use a proprietary low voltage LED that is designed to run only with DEKOR transformers. The LED's you receive have been fully tested and are rated for 100,000 hours.

We have installed a diode into the LED housing that will allow it to run on a 12vac circuit but with the following limitations and uncertainties.

**Caution:** You cannot inter-wire incandescent bulbs with LED bulbs. LED bulbs need to be on there own discreet circuit.

There are two ways you can kill a DEKOR LED prematurely.

- Not using a DEKOR transformer.
- Installing the LED in an environment where the ambient temperature will exceed 120 degrees F.

**WIRING:**

LED's can only be wired in **parallel** not in series. The colors on the LED wire lead are red and black. The red is the positive (+) circuit and the black wire is the neutral (-) circuit. Polarity must be maintained throughout your lighting system.

*Very Important:* When installing lighted basket balusters leave as much of the pigtail as possible in the baluster tube to allow for potential bulb replacement in the future.

PARALLEL WIRING

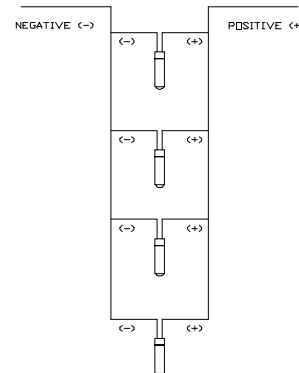

**MATERIALS:**

- We recommend using DEKOR outdoor rated wire, as well as using DEKOR self sealing wire connectors on all connections.

**LED Transformers and Installation Tools**

Just like the rest of our products our LED transformers are the best in the business We offer a transformer that has:

- Highly reliability with the longest warranty in marketplace ( 2 years )
- Extremely clean and regulated 12vdc output
- Over load /over voltage / over temperature / short circuit protection
- Rated for high moisture exterior and interior installations
- UL and CSA approved
- Handles domestic and international current
- Small size allowing easy hiding

**DEKOR ILLUMINATED PRODUCTS ARE ONLY WARRANTED WHEN USED EXCLUSIVELY WITH DEKOR BRAND DC TRANSFORMERS**

**EZ Transformer Kits**

DEKOR™ EZ Power Kits offer a variety of options depending on particular installation requirements.

Each EZ Kit include a photocell / timer which turns on the system at dusk, and allows for settings to run the system for 2, 4, 6, and 8 hours, or dusk to dawn. For controlling the system manually order the EZOUTPD60C which is designed to be hardwired directly into a switched outlet.

The EZ kits may be run on a switched outlet, but using a dimmer switch to control the outlet is not recommended and will void the warranty.

For determining the appropriate kit for your application, this table illustrates the total number of each type of light each kit can accommodate:

Model #	Down & Stair Lights	Post Lights	Post Cap Lighted Sides	Lighted Baskets Casey Collars	Maximum Capacity
<b>EZ</b>	<b>40</b>	<b>20</b>	<b>20</b>	<b>40</b>	<b>40</b>
<b>EZMAXC</b>	<b>140</b>	<b>70</b>	<b>70</b>	<b>140</b>	<b>140</b>

# EZ DIMMER INSTRUCTIONS

**INPUT CONNECTION:**  
Connects directly to the EZINDOORPOWERDRIVER, EZ, and EZMAX Transformers

**POWER BUTTON:**  
On/Off function

**OUTPUT CONNECTION:**  
Connects directly to either one of the pig tails shown right.

**MODE BUTTON:**  
This will dim the lights in four steps with a final step turning the lights off. Pressing the button after that will loop the lights back to full intensity.

**UP ARROW BUTTON:**  
Press and hold to increase the lights intensity to the desired amount.

**DOWN ARROW BUTTON:**  
Press and hold to decrease the lights intensity to the desired amount.

**Note:**  
Dimmer stores last light setting in memory even when no longer powered.

## REMOTE FOR EZ WATERPROOF DIMMER

**POWER BUTTON:**  
On/Off function

**UP ARROW BUTTON:**  
Press and hold to increase the lights intensity to the desired amount.

**DOWN ARROW BUTTON:**  
Press and hold to decrease the lights intensity to the desired amount.

**MODE BUTTON:**  
This will dim the lights in four steps with a final step that will shut the lights off. Pressing the button after that will loop the lights back on to full intensity.

The remote is already paired to the dimmer. In the event the remote is damaged or lost, a new one can be ordered.

WATERPROOF LED DIMMER AND REMOTE  
MODEL: EZDIMMERWP

# Framework You Will Need for Cable Railing

## End Post Construction

Since hundreds of pounds of tension is being applied to end posts using cable railing, those posts must be substantial enough to handle that tension.

For wood posts a minimum 4x4 (3½"-square) post is required to keep the post from bending when the cables are tensioned. You will need a top rail, and we recommend that it be reinforced with a support such as a 2x4 on end under the top rail (see illustration at right). End posts must be securely mounted to the deck to prevent the post from coming loose when the cables are tensioned. A bottom rail helps distribute the force away from the bottom of the post, but is not required.

For steel posts, kits are designed for use with 1½"x1½" square and 2"x2" square tube. End posts will need to be a minimum ¼" wall to handle the load when the cables are tensioned; intermediates can be 1/8". As with wood posts, you will need a top rail, but that is sufficient for structural integrity. For aluminum, your end posts should be reinforced and you may want to consider a bottom rail to help prevent post-bowing (see illustration below).

Of course, secure mounting of the posts to the deck is just as important with metal posts as wood, and as important with end posts as intermediates.

## Intermediate posts between end and corner posts

To keep the cable from spreading beyond standard code requirements, we recommend that the cable

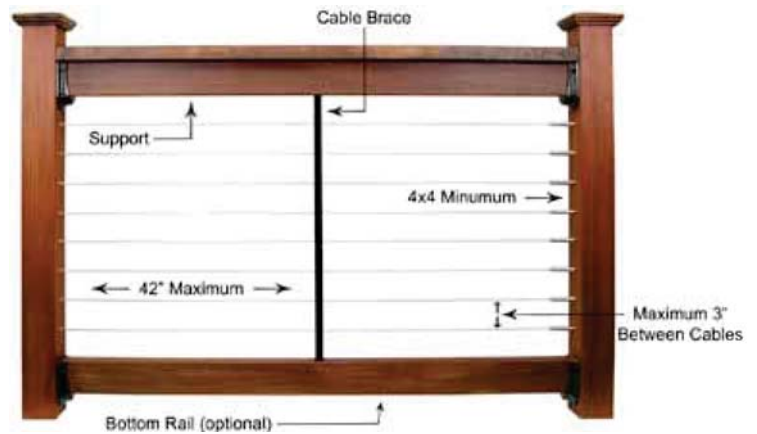

be supported in some manner no more than every 42" along its run. Intermediate posts, through which the cable is strung, act as supports for the cable. To avoid having to use more intermediate posts than is structurally necessary, a thin metal cable brace with holes for the cables to pass through can be used to support the cables (see illustrations).

## Cable spacing on your posts

We recommend that you space the cables with no more than a 3" clear span between the cables (see illustrations). For example, if you are using 3/16" diameter cable, you would drill your holes on center no more than 3-3/16" apart.

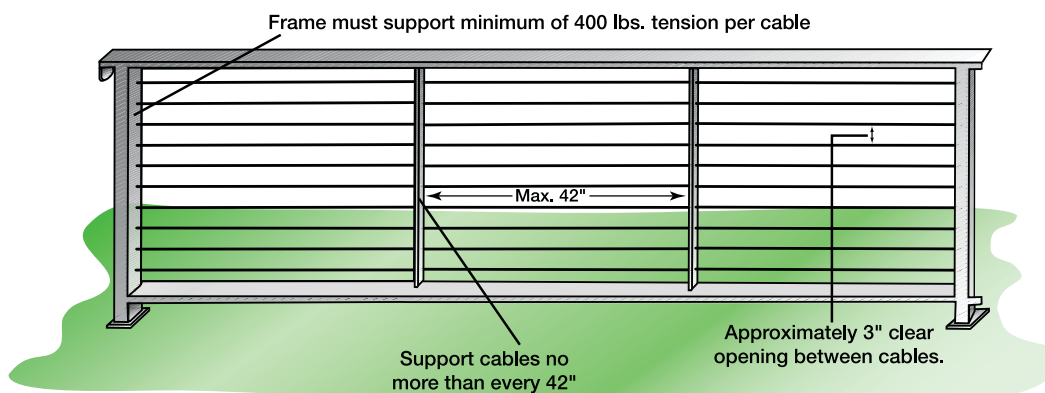



## Getting Started

Decks come in all shapes and sizes, but there are only a few types of cable runs that go on those decks. The following illustrations represent four different types of runs, all of which are straight runs that are less than 25' long, which involve no bending of the cable itself. Each run requires a fitting that will act to tension the cable once installed. The other end is a non-tensioning Push-Lock™ or Pull-Lock™ fitting.

We do not recommend any run be more than 25' long using just one tensioning device. If you have a run

that is longer than 25', or involves bending the cable, please call us for assistance in determining an effective solution.

### Sample Decks

You will see that Run #1 on each drawing is the "view run" — the one that is most important, most visible of all your runs. It's the one on which you want to have the least interference with the view, so you always start with that run and build around it.

## Stair Runs

Stair 1

The most economical approach is to go through both top and bottom end posts. The holes in the end posts, and any intermediate posts, must be drilled on the angle of the stairs. Selection for outside-of-post to outside-of-post configuration in Stair Run 1, with wood or metal posts:

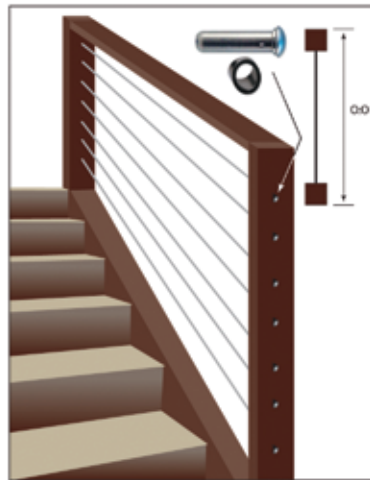

Use the 200 series (appropriate to post material) with beveled washers.



Stair 2

Top posts are often corner posts, which may require the stair run to connect to the inside of the post. The top and bottom of the cable run would be connected perpendicular to those posts, and only the intermediate posts would be drilled on the angle for the cable to run through.

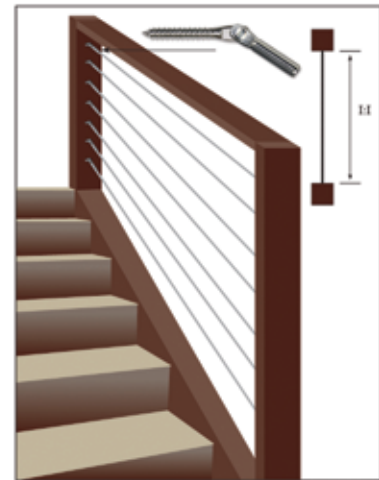

Selection for inside-of-post to inside-of-post configuration in Stair Run 2:

Use the 500 series, with LE-6 lag eye for wood posts or TT-6B threaded tab for metal posts.

The tensioning device is an Adjust-a-Body with Threaded Eye, which attaches via mounting screw to the lag eye or threaded tab. A Push-Lock with Threaded Eye attaches the same way to the other end.

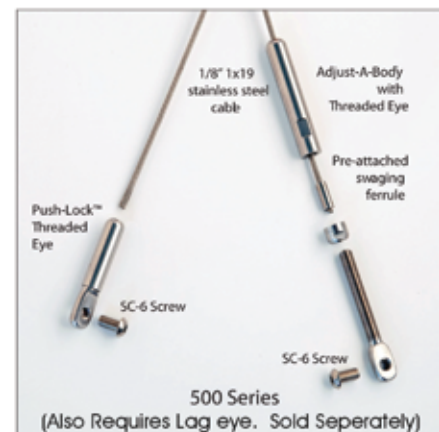

500 Series  
(Also Requires Lag eye. Sold Separately)

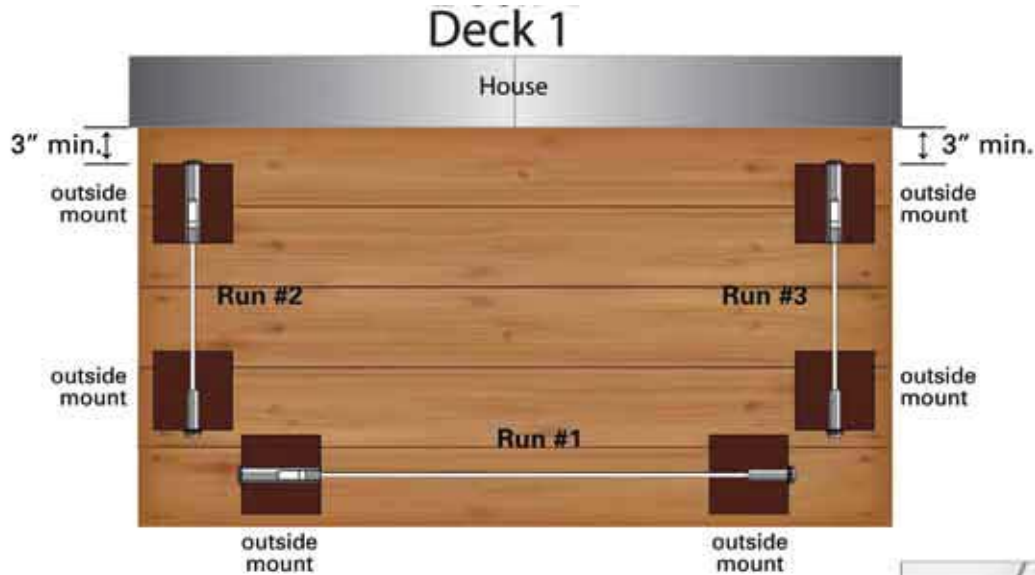

Deck 1 has dedicated end posts for each run, and the posts are situated such that the back side of the posts are all accessible, meaning you can use an outside-of-post to outside-of-post configuration for all runs. This is both the most economical and least visible solution.

Options for all runs on Deck 1:  
If wood posts, use the 262 series.

The tensioning device is a 3½"-long Invisiware Receiver, which installs flush through the wood post on one end. A Pull-Lock fitting is installed through the other end.



Like Deck 1, Deck 2 has dedicated end posts, but in this case, the posts next to the house are too close to access the back side of the posts. Run #1 is still outside to outside, so it will take the same configuration as on Deck 1. However, for Runs #2 and #3, you will attach to the inside of the posts next to the house and run through the post at the other end.

Options for inside-of-post to outside-of-post configuration in Runs #2 and #3:

If wood posts, use the 601 series.

The tensioning device is a 3½"-long Invisiware Receiver, which installs flush through the wood post on one end. A Push-Lock Lag is lagged into the other end.





On Deck 3, there is now only one end post at the corners. The posts next to the house butt right up to it so the back sides of those posts are not accessible. Run #1 is still outside to outside, so it will take the same configuration as on Deck 1. Runs #2 and #3 will need to connect to the inside of the corner post going back toward the house to keep the cables on the same plane. They will also need to connect to the inside of the posts next to the house as well.

Options for inside-of-post to inside-of-post configuration in Runs #2 and #3:  
If wood posts, use the 300 series.

The tensioning device is an Adjust-a-Body with Hanger Bolt, which lags into the wood post on one end. A Push-Lock Lag is lagged into the other end.



On Deck 4, there are still single posts at the corners. Run #1 is still outside to outside, so it will take the same configuration as on Deck 1. Runs #2 and #3 will need to connect to the inside of the corner post going back toward the house to keep the cables on the same plane, and since there is room behind the post next to the house, you can go through that post.

Options for outside-of-post to inside-of-post configuration in Runs #2 and #3:  
If wood posts, use the 601 series.

The tensioning device is a 3½"-long Invisiware Receiver, which installs flush through the wood post on one end. A Push-Lock Lag is lagged into the other end.



## Corner Posts Installation Methods

While you can offset cables on intersecting runs to use less expensive fittings, most people want all their cables to exist on the same plane, to give the impression that cables are continuous.

Ultra-tec fittings are designed to be able to reside within the same post in many configurations. Below are some examples of how your kit components work together.

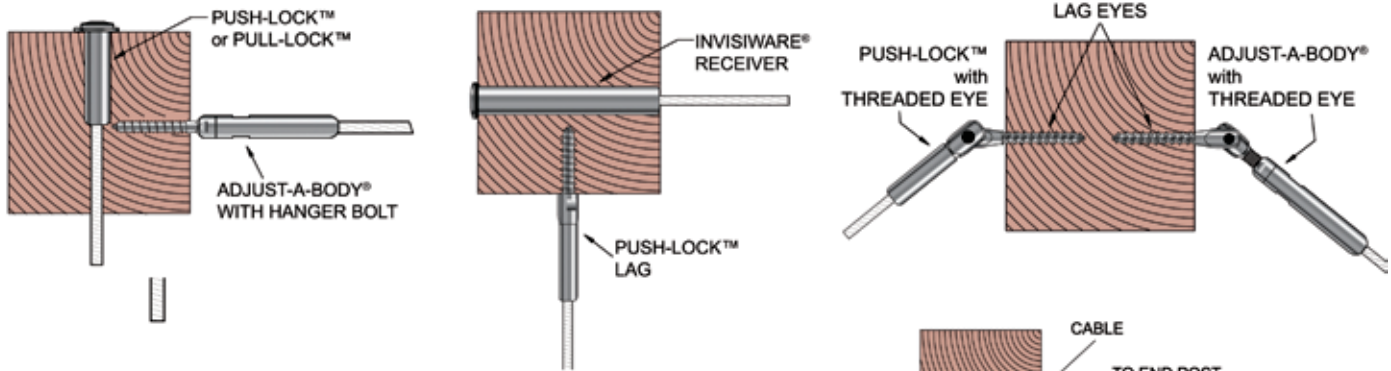

### Going Around Corners

Yes, you can go around corners, and yes, you can use cable for runs in excess of 25 feet, but it's best not to try to do it with one of these kits. For projects with these kinds of runs, contact us and we'll map out the railings for you as they'll best, and most economically, work.

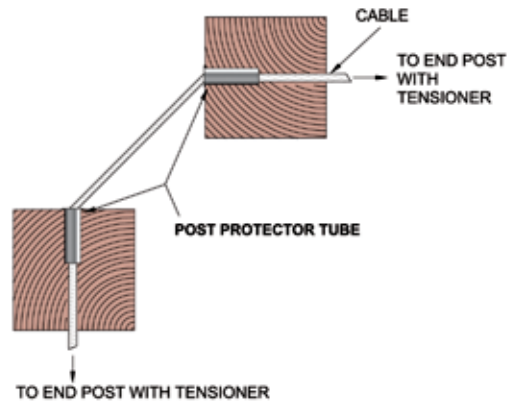

## Cable Railing Kits w/ Double Tensioners



272 SERIES

### Outside of Post to Outside of Post Rail Kit for Wood Post

Sold in kits.

Cable Railing Kit, made in USA from 1/8" high quality 316 grade stainless steel includes 1 strand of cable w/ swage, Adjust-a-body® w/hanger bolt, Push-Lock™ lag. This kit works where access to the back sides of both posts are limited.

Item #: 27250 - 50' Cable Kit  
Item #: 27260 - 60' Cable Kit

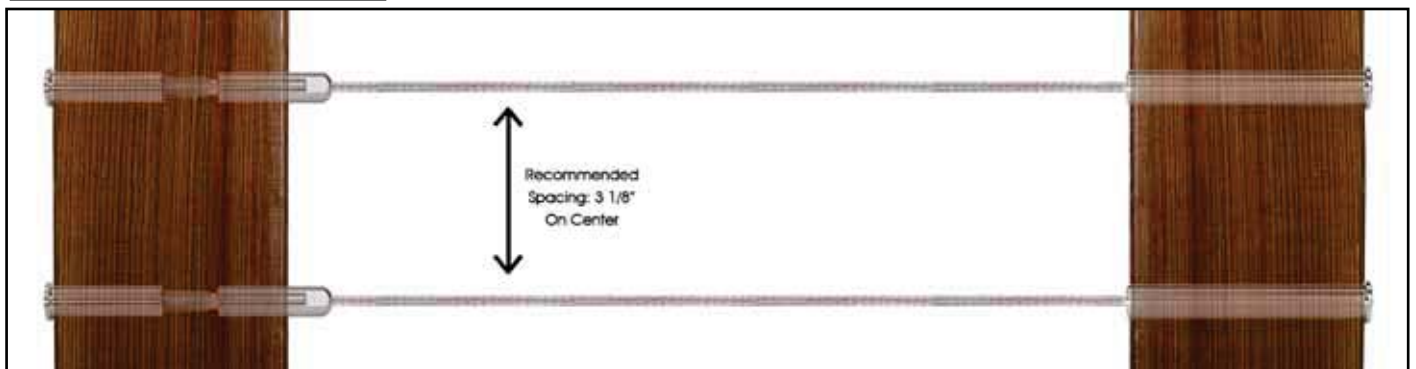



672 SERIES

### Inside of Post to Outside of Post Rail kit - Wood Post

Sold in kits.

Cable Railing Kit, made in USA from 1/8" high quality 316 grade stainless steel includes applicable washer, 1 strand of cable w/swage, Invisiware® receiver and Push-Lock™ lag. This kit works well where access to the back side of one post is limited.

Item #: 67250 - 50' Cable Kit  
Item #: 67260 - 60' Cable Kit



PUSH-LOCK™ TURNBUCKLE



ADJUST-A-BODY® WITH HANGER BOLT TENSIONER

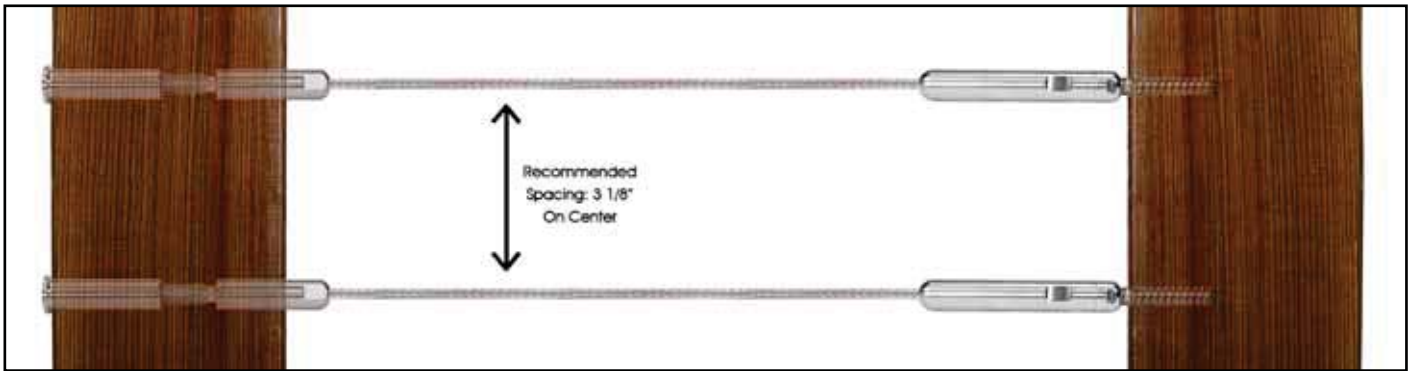

371 SERIES

### Inside of Post to Inside of Post Kit for Wood Post and Composite Sleeves

Sold in kits.

Cable Railing Kit, made in USA from 1/8" high quality 316 grade stainless steel includes 1 strand of cable w/ swage, Adjust-a-body® w/ threaded eye, and Push-Lock™ w/threaded eye.

Item #: 37150 - 50' Stair Cable Kit  
Item #: 37160 - 60' Stair Cable Kit



ADJUST-A-BODY® WITH HANGER BOLT TURNBUCKLE TENSIONER



ADJUST-A-BODY® WITH HANGER BOLT TENSIONER

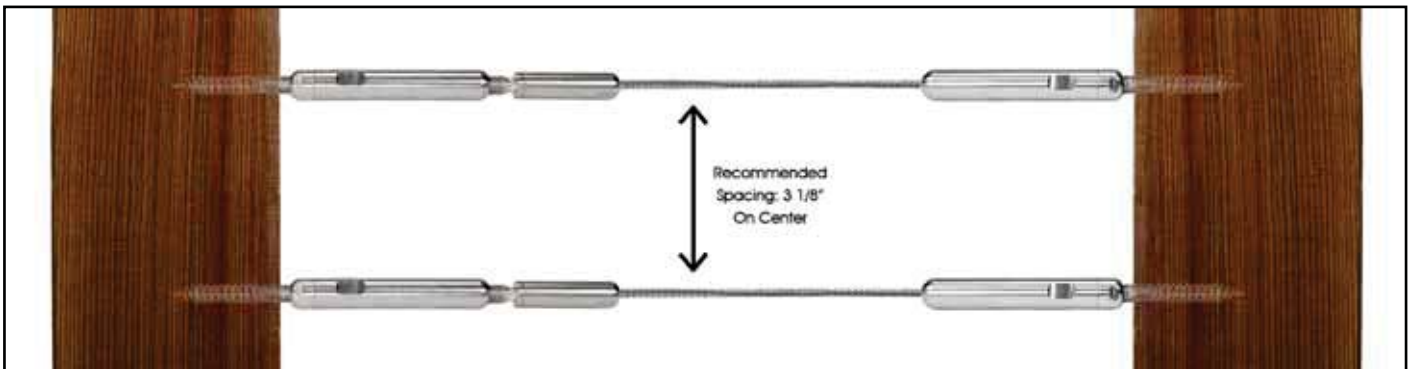

## ADI Undrilled Aluminum Cable Brace Layout & Drilling Instructions for Stairs

1. Determine where your post will be mounted and secure them into place. The final location of the post is crucial when determining where the holes will need to be drilled.

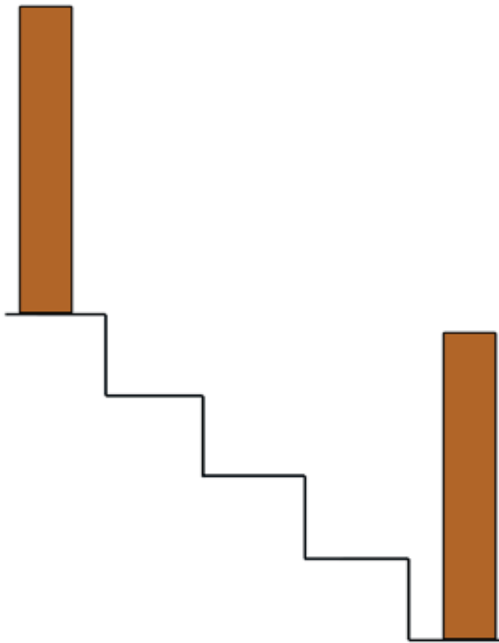

2. Once the posts have been installed, place a straight edge across the nose of the stairs to find the angle. Mark where the straight edge meets the post. This is where your first hole is drilled.

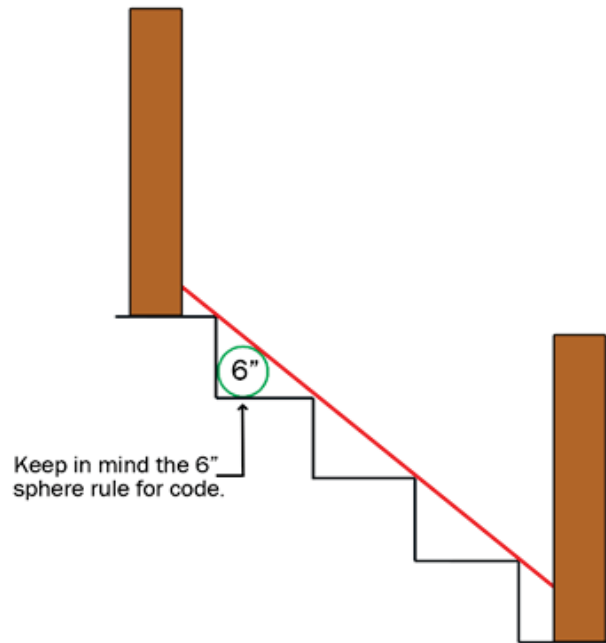

3. Continue marking up the post in 3 1/8" increments (or whatever cable spacing is being utilized). Once all holes are marked, pre-drill the holes perpendicular to the post with 9/32 drill bit. (for lag fitting)

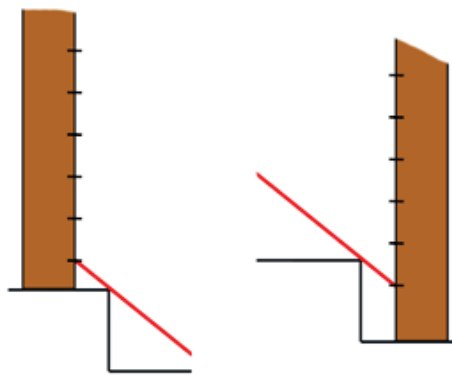

4. After you have pre-drilled the holes, screw in the lag eye fitting that will be used in conjunction with the 500 series cable kits. (please reference separate instructions for cable installation)

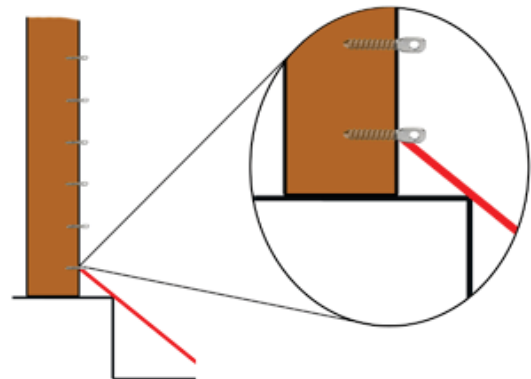

## ADI™ Undrilled Aluminum Cable Brace Drilling Instructions for Stairs

5. Determine the location that your cable brace will be mounted on the stairs. Place your cable brace at that location.

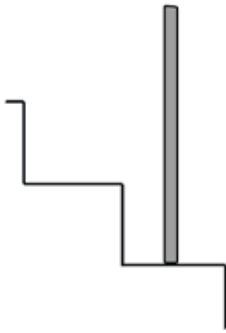

6. Hold the cable brace in place and run a string from the first hole of the top post to the first hole of the bottom post.

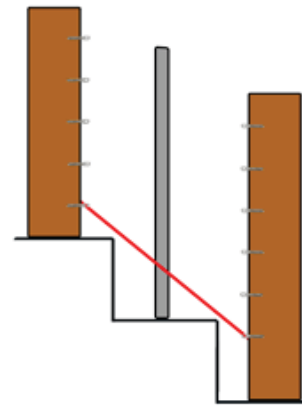

7. Using the string as a guide, mark the upper and lower points (two points) where the string comes across the brace, then transfer those points to the sides where the holes will be drilled. Make sure to center your holes on the brace.

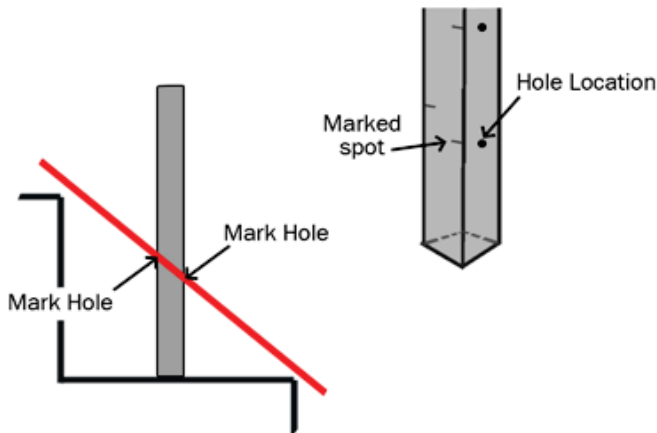

8. Continue marking up the brace on both sides in 3 1/8" increments from the first hole. Once all holes are marked, drill straight holes with a 3/16" drill bit. (holes are slightly oversized to allow for angle of cable)

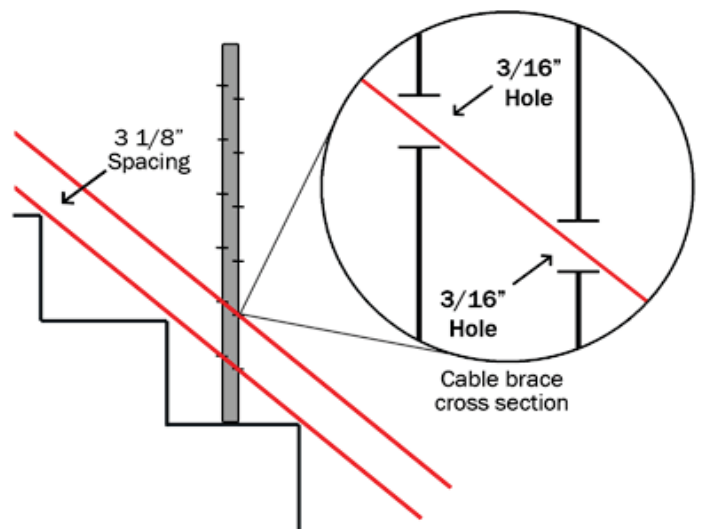

### Trick of the trade:

A cocktail straw can be used as a guide for pushing the cable through the brace.

## Post Cover Installation

1) Post covers are 41" tall. Measure up 41" on the post and cut the post to this height. (Fig. 1)

2) If using a 6x6 post, skip ahead to #8.

3) When using a 4x4 post, either fir out the post to 5 1/2 x 5 1/2 or use the optional Converter Kit Rings. 4 pieces per kit. (Fig. 2)

4) Place the bottom ring (marked B), flange down, onto the deck. Pre-drill the four sides and attach the ring to the post using 2" galvanized screws. Use shims to make the ring snug and centered on post. (Fig. 3)

5) Measure up 13" and 26" from the deck. Use a Speed Square to mark a line around the post at these heights. Slide the 2 rings (marked M) to these heights, shim and screw in place as described above. (Fig. 4)

**If attaching railings, the following must be done PRIOR to the placement and attachment of the post.**

Measure up and mark on the post to the height of the bottom and top rail. Fir out the post on these faces at these heights an additional 1". These will act as the landings for the rail mounts. Use a 3"x3" x1" block. Center the block at the scribed line. (Fig. 5)

**Consult local codes for height requirements of rails.**

6) Slide the post over the rings, and seat the bottom of the post into the bottom ring. Face screw the post to the rings using 2 1/2" galvanized screws. It is best to screw through the post in a grout line or at the base of a rock. This will make it easier to hide the screws. Measure up 13" and 26" and screw through the rings at this height. (Fig. 6)

7) Place the top ring and seat in the top of the post. Shim to make the post plumb. Screw through the indented areas into the post.

8) If using a 6x6 post, simply cut the post to 41", slide the post cover over the post, and secure using 2 1/2" galvanized screws as described in #6 above. Be sure and shim the top of the post to make it plumb before screwing the post cover to the post.

9) Attaching the Cap. Apply adhesive around the top surface of the post. (Fig. 8) In addition, apply adhesive to the inside top of the cap along the inside ledge.

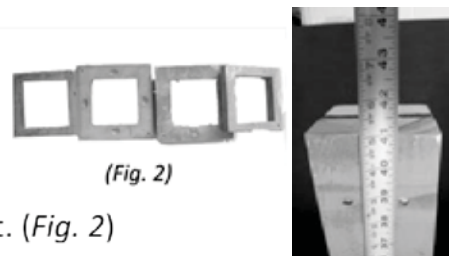

(Fig. 1)



(Fig. 2)



(Fig. 3)



(Fig. 4)



(Fig. 5)

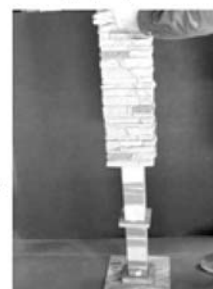

(Fig. 6)

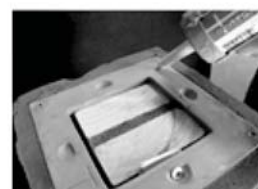

(Fig. 8)



## 2 Piece Post Cover Installation

1) Post covers are 41" tall. Measure up 41" on the post. Cut the post to this height. (Fig. 1)

2) If using a 6x6 post, skip ahead to #6.

3) When using a 4x4 post, either fir out the post to 5 1/2x 5 1/2 or use the optional Converter Kit Rings. 4 pieces per kit. (Fig. 2)

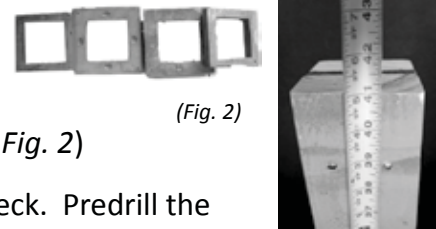

(Fig. 2)

(Fig. 1)

4) Place the bottom ring (marked B), flange down, onto the deck. Predrill the four sides and attach the ring to the post using 2" galvanized screws. Use shims to make the ring snug and centered on post. (Fig. 3)

5) Measure up 13 1/2" and 27 1/2" from the deck. Use a Speed Square to mark a line around the post at these heights. Slide the 2 rings (marked M) so the bottom of the ring is on these lines, shim and screw in place as described above. (Fig. 4)

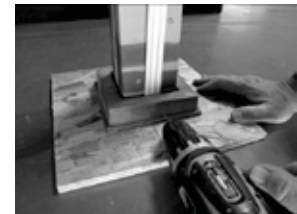

(Fig. 3)

**If attaching railings, the following must be done PRIOR to the placement and attachment of the post.**

Measure up and mark on the post to the height of the bottom and top rail. Fir out the post on these faces at these heights an additional 1". These will act as the landings for the rail mounts. Use a 3"x3" x1" block. Center the block at the scribed line. (Fig. 5)



(Fig. 4)

**Consult local codes for height requirements of rails.**

6) Position Side 1, with the arrow facing up. Seat the bottom of the post into the bottom ring. Face screw the post to the rings using 2 1/2" galvanized screws. It is best to screw through the post in a grout line or at the base of a rock. This will make it easier to hide the screws. Measure up 14" and 28" and screw through into the rings at this height. The posts are designed with a grout line at these heights. (Fig. 6)



(Fig. 5)

7) Place the top ring and seat in the top of the post. Shim to make the post plumb. Screw through the indented areas into the post. (Fig. 7)



(Fig. 6)

8) After securing side 1 in place, move side 2 into place. Make sure the arrow is facing up. Dry fit the piece to make sure all "T" joints line up and are tight. Secure side 2 at the ring heights described above. (Fig. 8)



(Fig. 7)



(Fig. 8)

## 2 Piece Post Cover install cont.

9) Attaching the Cap. Apply adhesive around the top surface of the post. (Fig. 8) In addition, apply adhesive to the inside top of the cap along the inside ledge. ( Fig. 9)

10) Install Rail Mounts.

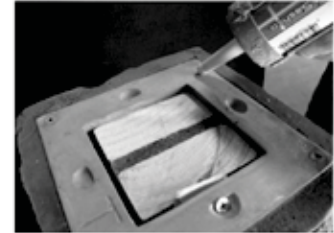

(Fig. 8)

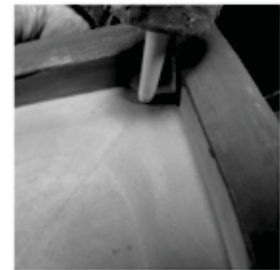

(Fig. 9)

### Spacer Block Installation Instructions



**Step 1:**  
Determine location of spacer block and trace.



**Step 2:**  
Using a rotary tool or reciprocating saw, follow the outline and cut.



**Step 3:**  
Ensure spacer block fits freely into opening.



**Step 4:**  
For 6x6 post, fasten spacer block to substrate using the 4 screws provided. (4x4 requires 2 spacer blocks to be stacked together)



**Step 5:**  
Place assembled rail section onto the spacer block.



**Step 6:**  
Fasten railing connector to spacer block using the screws provided.

11) Finish the job using NextStone Textured Grout and Paint kit to cover any gaps between the 2 post cover pieces, space around the mountings and to hide screw heads. (Grout and Touch Up Kit sold separately).

**TITAN**<sup>TM</sup> *The most advanced wood post anchor system available...ANYWHERE!*  
THE ART OF BUILDING

**Wood Post Anchor Installation**

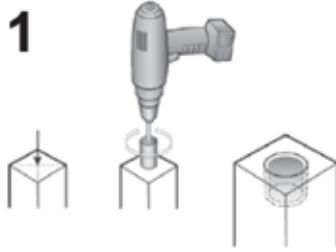

No knots in the lower 8" of the post  
Do not use kiln dried wood

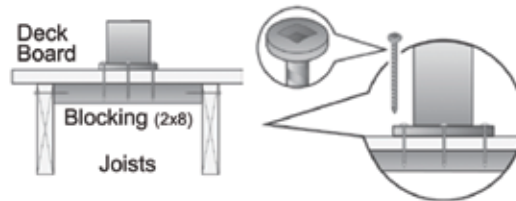
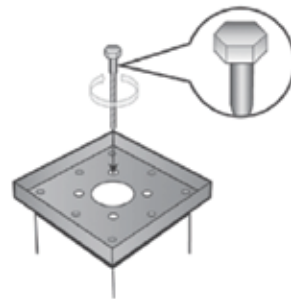
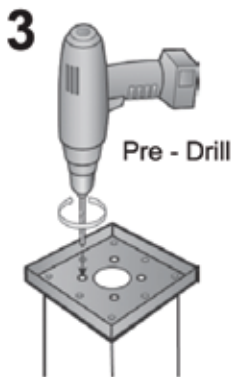
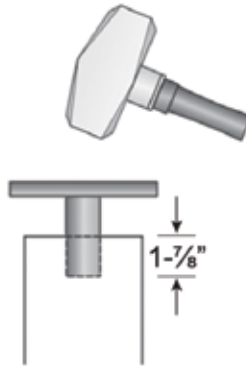
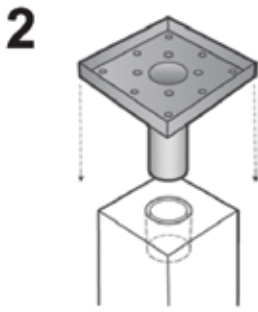
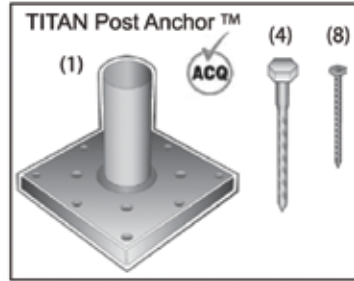

Pre - Drilling Guide		
Lag screw	Softwood	Hardwood
5/16"	3/16"	9/32"
3/8"	1/4"	11/32"

Titan Installation Video



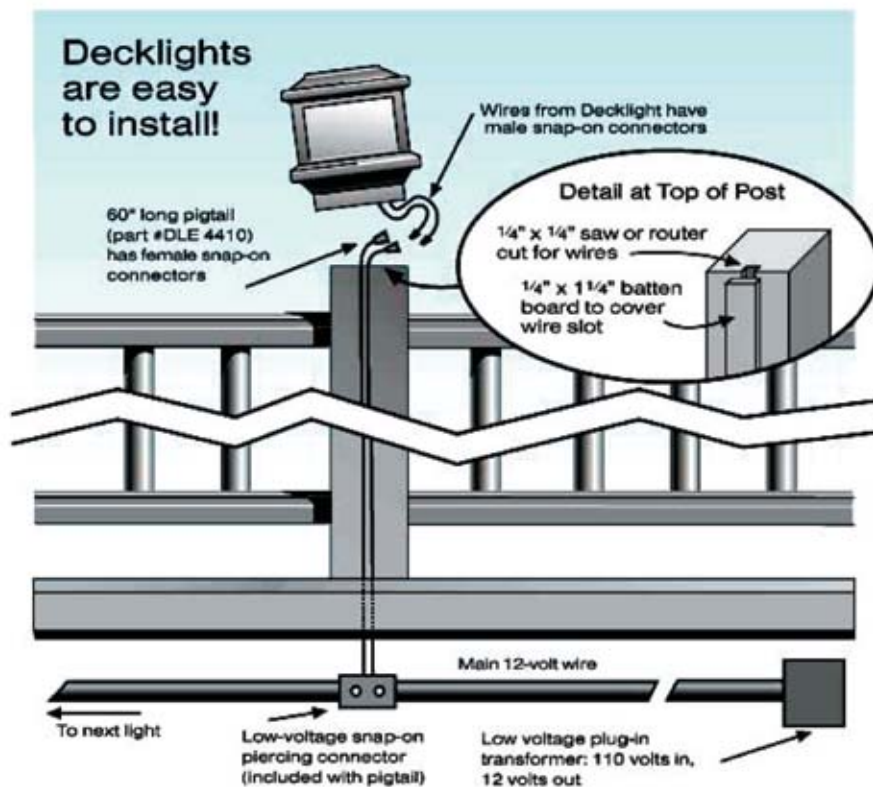

### Before You Start

- Read and Understand the instructions completely.
- Be sure electrical current is turned off.
- If you have any doubts about how to install fixture, please contact an electrical contractor.

### Installation

1. Connect Deck light only to a 12 volt power source
2. Connect wires from "12 volt supply line" to the Deck light (Push connectors together, if using the DLE4410) or if using standard wire attach with wire nut.
3. Attach Deck light to post using screws provided.
4. The Deck light includes (1) 18 watt, 12 volt bulb
5. Turn on power to confirm light is on

**Main low voltage wire:** Be sure to use a minimum of 12-gauge, UV protected, exterior grade wire. To determine the amount of wire required, measure the distance from the furthest light, in series, back to where the transformer will be mounted (interior or exterior, wherever an outlet is available). Each light is wired "daisy chain" style to the main low voltage wire, using the DLE4410 pigtail. The wire is typically sold in 100', and 500' coils. The wire can be run above ground, under the joist or under the handrail, through the vinyl, or under ground. It is low voltage, so it need only be buried 3" or so underground. Wiring should not exceed 200' runs. If 200+ feet is required, please refer to transformer instruction sheet for additional wiring options.

**Transformer:** Transformers are specified per the installation. Always size the transformer as close as possible to the required wattage draw, without going over. The wattage output of the transformer is important; you do not want too much or too little output on the transformer. To determine the size of the transformer, add up the total number of light-watts. This is the wattage of the fixture times the number of fixtures. Example: 6 each DLA6040 = 6 lights x 18 watts = 108 watts. Then select the next larger size transformer, in this example 121 watt transformer. Transformers usually have built in timers to set on/off times, as well as a manual override, or have a built in photo-eye for automatic on/off applications. With a switched exterior outlet your transformer can be controlled from indoors.

## Frequently Asked Questions:

- **How many lights can I install on a transformer?** Up to 50 lights. See transformer section. For further detail, read the transformer instruction sheet included with the transformer
- **How do I install wire in a wood post?** Simply cut or route a channel vertically on the face of the post. Once wire is installed, cover with a batten strip or cut a filler piece to match the slot size. Additionally, the wire can run under the handrail. In this application, drill a hole from the top of the 4x4, on an angle, to meet the underside of the handrail. Run wire from post to post, under the handrail.
- **Can I put the lights on an inside switch?** Yes. To do so, the outlet that the transformer plugs into must be wired to the desired switch. The transformer is then placed in “manual mode”, operated by the light switch.
- **What type of bulb is used, and where do I get replacements?** The bulb is a standard automotive brake light bulb, and can be purchased at any auto parts store.
- **Can the light output be reduced on the low voltage light?** A 13 watt bulb is available to reduce the light output if desired.
- **Can a dimmer switch be used?** Dimmer switches are not effective on low voltage lighting.
- **Some lights appear dimmer than others, what do I do?** This is a result of wiring issues. Primary due to longer distances from the transformer (200 or more feet). There are several different wiring schemes to address and/or correct this. Please refer to the transformer instruction manual to correct.

## Warranty Information

Unless otherwise noted, all Aurora Deck Light products are covered by a one-year limited warranty.

Aurora Deck Lights warrants this product against defects in materials or workmanship as follows:

For the first year from the date of purchase, Aurora Deck Lights will repair or replace the unit, at our option, without charge for parts or labor. After the indicated period of one year, the product owner is subject to pay repair and parts fee.

This limited warranty is non-transferable, and consequently only valid toward the purchaser of this product. It does not cover damage or failure caused by or attributable to natural disaster, abuse, misuse, improper or abnormal usage, faulty installation, improper maintenance, lightning, or other incidences of excessive voltage, or any repairs or tampering by other than by Aurora Deck Lights or its Authorized Service Center. Repair or replacement under the terms of this warranty does not extend the terms of this warranty.

Should this product be proven defective in workmanship or material, the consumer’s sole remedies shall be such repair or replacement as provided by the terms of this warranty. Under no circumstances shall Aurora Deck Lights be liable for any loss or damage, direct, consequential, or incidental, arising out of the use of or inability to use this product. Some states do not allow limitations on how long an implied warranty lasts or the exclusions or limitations of incidental or consequential damages, so the above limitations or exclusions may not apply to the product owner. This warranty gives the product owner specific legal rights. The product owner may also have other rights, which vary from state to state.

To obtain warranty service, contact Aurora Deck Lights Service Department at 1-800-603-3520 or at [www.auroradecklighting.com](http://www.auroradecklighting.com). When returning a unit for warranty service, the product owner must obtain a return merchandise authorization number from a service representative of Aurora Deck Lights. In addition, please include a copy of the product owner’s sales receipt, a brief description of the symptoms, name, address, and phone number. Then deliver or ship the product, postage or shipping costs prepaid (insurance suggested), to:

Aurora Deck Lights  
499 W. Whitewater Street  
Whitewater, WI 53190

All warranty repair or replacement will be returned to the customer using UPS® Ground service or other carriers at our option. If a faster carrier method is requested, the product owner must pay the cost difference over the UPS® Ground service charge. Aurora Deck Lights is not liable for products lost or damaged during shipment.

## Low Voltage and Solar Deck Lighting Alternatives

1. Deck Light Products & Accessories
2. Specifying Lighting Products
3. Product Installation – You CAN do it!
4. Frequently Asked Questions

Brought to you by:



*Light Up Your Outdoor Life With Decklights!*

### Deck Light Products

Lighting products for exterior applications can be broken down into three categories:

- Low Voltage (12 Volt)
- Line Voltage (110 Volt)
- Solar Powered

#### Low Voltage Lighting:

Low voltage lighting utilizes a transformer to step the power down to 12 volt from 110 volt; the transformer is plugged into a standard wall outlet. Most transformers are approved for use indoor and outdoor. The wiring and installation method used on low voltage deck lighting is the same principle as low voltage landscape lighting: From the power source, the low voltage wiring is run in series from one light to the next, connecting all lights on one “main” low voltage wire. Connection to this main low voltage wire varies by manufacturer. Step lights, pathway lights, and accent lights can be attached to this same main low voltage wire. Installation is very easy with low

voltage wire, and the most areas of the US do not require an electrician for installation. In addition, low voltage lighting uses relatively little power. Always size the transformer to the closest total wattage being used on the job, without exceeding the wattage of the transformer. Under-sizing the transformer will cause the furthest lights from the transformer to appear dimmer than the others. In addition, under sizing the transformer will cause the transformer to fail. Over-sizing the transformer will cause all of the lights to appear brighter than they should be, and will reduce bulb life. Daisy chaining, or wiring lights in series should not exceed a total lineal footage of 200'. If the application requires wire runs over 200', see the wiring diagrams included with the transformer for different wiring options.

### Line Voltage Lighting:

Line Voltage Lighting is available for posts, walkways, "brick" lights, and other landscaping applications. The most common benefit of line voltage lighting is the ability to install these lights on the same switch as other lights, thereby allowing these to be controlled from inside the house. Other applications include pool areas where 110V circuitry is available, yet an outlet may not be readily available. Power source in this environment can typically be drawn from the pump house. A drawback to 110V lighting is that it typically requires a licensed electrician to install, and many municipalities require a permit for installation.

### Solar Lighting:

Solar Lighting products provide an accent to deck and/or fence installations. Technology available today has brought solar powered lighting to the deck industry in a price range that is affordable to the typical deck customer. Solar technology currently available is accent lighting, and should be sold as such. Solar powered lighting does not provide the kind of area lighting that low voltage or line voltage lighting will provide. Power to recharge the batteries is provided by the natural sunlight. Solar lights have LED bulbs, and NiCad batteries. The batteries charge during the day, and the photo-eye activates the LED lights at dusk. Run time is based on the season, and location. Northern climates will have a run time during the summer of 8-14 or more hours, and 3-6 hours during the winter months. The amount of sunlight is a direct correlation to run time – cloudy days will effect the run time. These lights need direct sunlight to charge the battery. Mounting under trees, under eaves, etc., will inhibit the ability to charge.

Within these categories, lighting products are further categorized by post size: 2", 2 ½", and 3" ornamental, 3 ½" wood post, 4" or 5" vinyl post, and 5 ½" wood posts. There are conversion bases for over-sized posts such as 4 ¼" - 4 3/8" composite sleeve posts, etc.

**Matching Caps:** Matching caps are available, used on posts where lights are not installed. These are also heavy duty cast aluminum, and styled to match the post light.

## SPECIFYING THE PRODUCT:

The first thing to specify on a job is the number of lights. All related specifications revolve around the number of lights. Next, determine the actual post size – specify the **actual** size, not the nominal size. This is important, as different people will refer to post sizes in different ways. Our 4x4 Deck light for wood post fits a post with an actual size of 3 ½" x 3 ½".

Once the number of lights and the actual size is determined, next specify the **style** and the **color**. There are 6 styles to choose from, and up to ten color options depending on the style chosen. Many of these colors match the Deckorators balusters. Next, specify a connection method for each light. For example, the Deck light line uses a **DLE4410 pigtail** for each light. This connects the light to the **main low voltage** wire for quick and dependable installation.

**Main low voltage wire:** Be sure to use a minimum of 12-gauge, UV protected, exterior grade wire. To determine the amount of wire required, measure the distance from the furthest light, in series, back to where the transformer will be mounted (interior or exterior, wherever an outlet is available). Each light is wired "daisy chain" style to the main low voltage wire, using the DLE4410 pigtail. The wire is typically sold in 100' and 500' coils. The wire can be run above ground, under the joist or under the handrail, through the vinyl, or under ground. It is low voltage, so it need only be buried 3" or so underground. Wiring should not exceed 200' runs. If 200+ feet is required, please refer to transformer instruction sheet for additional wiring options.

**Transformer:** Transformers are specified per the installation. Always size the transformer as close as possible to the required wattage draw, without going over. The wattage output of the transformer is important; you do not want too much or too little output on the transformer. To **determine the size of the transformer**, add up the total number of light-watts. This is the wattage of the fixture times the number of fixtures. Example: 6 each DLA6040 = 6 lights x 18 watts = 108 watts. Then select the next larger size transformer, in this example 121 watt transformer. Transformers usually have built in timers to set on/off times, as well as a manual override, or have a built in photo-eye for automatic on/off applications. With a switched exterior outlet your transformer can be controlled from indoors.

**Accessories:** Finally, determine the number of matching caps, and rail adaptors if mounting to a flat surface such as a handrail.



## FREQUENTLY ASKED QUESTIONS-LOW VOLTAGE

- 1. How many lights can I install on a transformer?** Up to 50 lights. See transformer section. For further detail, read the transformer instruction sheet included with the transformer. You may add lights to your system as long as the total watts of all the lights does not exceed the rated watts of the transformer.
- 2. How do I install wire in a wood post?** Simply cut or route a channel vertically on the face of the post. Once wire is installed, cover with a batten strip or cut a filler piece to match the slot size. Additionally, the wire can run under the handrail. In this application, drill a hole from the top of the 4x4, on an angle, to meet the underside of the handrail. Run wire from post to post, under the handrail.
- 3. What type of bulb is used, and where do I get replacements?** The bulb is a standard automotive brake light bulb, and can be purchased at any auto parts store.
- 4. Can the light output be reduced on the low voltage light?** A 7.5 watt bulb is available to reduce the light output if desired.
- 5. Can a dimmer switch be used?** Dimmer switches are not effective on low voltage lighting.
- 6. Some lights appear dimmer than others, what do I do?** This is a result of wiring issues. Primarily due to longer distances from the transformer (200 or more feet). There are several different wiring schemes to address and/or correct this. Please refer to the transformer instruction manual to correct.
- 7. What is the product warranty?** The Deck light product is warranted against manufacturer defect for a period of one year. Product replacement is provided at no charge during this warranty period. Product must be returned to Deck lights for inspection at customer expense. Deck lights does not provide for any labor costs related to product warranty.
- 8. What if my product is out of warranty?** Deck lights would like to insure long-term customer satisfaction. In the event that there are product related issues after the first year, Home Tops will address these on a case-by-case basis.
- 9. I have low voltage landscape lighting; can I add Deck lights to this?** Generally, the answer is no. It is best to start from scratch, for two reasons: First, the transformer likely has less wattage output than is necessary for the Deck lights. In addition, landscape lighting usually uses 18-gauge wire, which is too light for the Deck light product. Using this will cause a drop in wattage, making the lights appear dimmer.
- 10. Can I put the lights on an inside switch?** Yes. To do so, the outlet that the transformer plugs into must be wired to the desired switch. The transformer is then placed in "manual mode", operated by the light switch.
- 11. Can I change the glass style in the light?** Yes, glass can be purchased separately to change between the styles. This includes new Tiffany Opalescent Glass in red, white, blue, and green.

12. **What does the statement “First fixture must be 10 feet from power pack” mean and why?**  
You must have at least 10 feet of cable between the first fixture and the power pack to avoid premature bulb burn-out. The cable may be buried, coiling is not recommended.
13. **My lights start out bright but dim towards the end of my cable. What’s wrong?**
  - a. Check to make sure the end of your cable has a clean cut and none of the strands of wire are touching the other side.
  - b. If you have any spliced cable off your main run, make sure this splice is soldered and you have a secure connection.
  - c. Check the connection at each light. A loose or frayed wire will cause voltage drop.
14. **Is there a positive or negative in the wires or cable?** There is no polarity in the wires or cable unless you loop it to the transformer which is not necessary.
15. **What is voltage drop?** Voltage drop is caused by the electrical resistance of the cable which restricts the flow of electricity. The smaller the cable size and the more lights used, the lower the light output will be along the cable. When voltage drop occurs, you may experience insufficient light output, particularly with the lights farthest away from the transformer. Voltage drop can be minimized by switching to a lower gauge of cable.
16. **Should transformers be used to their full capacity?** Yes. As the load decreases, the output voltage of the transformer increases. Therefore, the life of low voltage lamps will be shortened unless the transformer is carrying close to its rated capacity. The rule of thumb is to use at least half the transformer’s wattage rating.
17. **Can more than one run be attached to my power pack?** Yes, only two separate runs are recommended. Both runs attach under A and B terminals and may not exceed the total power pack wattage rating.
18. **Can you mix different wattage fixtures on the same cable run and transformer (e.g. 14-watt floodlights with 18-watt entrance light fixtures)?** Yes. To mix different wattage fixtures, add up the total wattage of the lamps. As long as their total wattage does not exceed the output of the transformer, you can mix and match lights.
19. **Can power packs be installed indoors?** No. Power packs are listed as outdoor products only by Underwriter Laboratories and the Canadian Standards Association.
20. **What is the “C” terminal used for on my transformer?** The “C” terminal is for use only with the optional 3 wire photo control accessory.
21. **My transformer timer dial does not rotate. The lights come on manually just fine. What’s wrong?** This is a defective power pack. Send this unit under warranty along with the proof of purchase to this address:

## FREQUENTLY ASKED QUESTIONS-SOLAR LIGHTS

- 1. What is the run time on the solar light?** The run time will vary based on the season. During the summer months, the solar light will run for up to 14 hours. During the winter months, the shorter daylight hours, as well as cloudy days, will reduce the run time to approximately 3-6 hours.
- 2. How long will the Solar lights last?** The LED bulbs are designed to last a lifetime, as is the solar collector. These are of the highest quality and latest technology available today. The batteries are 9V NiCad batteries. These will last approximately 1000 cycles, or roughly three years. Batteries are warranted for one year. Replacements can be purchased locally or through Home Tops.
- 3. My solar light will not light up?** The most common issue is the battery. It takes up to three weeks for a new solar unit to cycle to full capacity. Winter months will effect this cycle time as well, if installed in the middle of winter. To test a solar unit, remove the NiCad batteries, and install AA alkaline batteries. Cover the entire solar collector to test the unit. If the unit lights up, replace the NiCad batteries.
- 4. Can I change the glass style in the light?** Yes, glass can be purchased separately to change between the styles. This includes new Tiffany Opalescent Glass in red, white, blue, and green.
- 5. Battery Replacement.** You must NOT use regular alkaline batteries in this product. Replacement Batteries must be Rechargeable NiCD size AA, rated 600mAh or higher. Batteries can be purchased from any reputable electronics, hardware, camera or hobby store. Use of any other battery type will void warranty and may ultimately damage the Solar Light beyond repair. To replace the batteries, follow the steps A and B below, removing and replacing the existing batteries. NOTE: Do not touch or attempt to remove the LED light source. The batteries must be fitted as indicated by the diagram at the bottom of the battery chamber.
- 6. Rechargeable Batteries.** Rechargeable batteries have been supplied with this Solar Light. You must activate the batteries before the Solar Light can be used.

To do this:

- Remove the four screws holding the top portion of the Solar Light. Remove the plastic tab covering the battery terminals. Replace the four screws holding the top portion of the Solar Light.
- Test the batteries: The solar panel automatically turns the solar light off upon detecting sunlight. Cover the solar Panel with your hand. The solar LED lights should illuminate. Occasionally the batteries will drain prior to initial use. If this occurs, the solar light should be placed in direct sunlight for a period of up to two weeks before reaching full operating charge.

RF dimmer is a controller that can adjust light to the appropriate lighting brightness incrementally.

### Supplemental Instructions

This 12V DC Low Voltage Remote Control Dimmer is to be used only with Aurora Deck Lighting DC Transformers and Lighting Products. Failure to follow installation instructions and/or use with other brand products will void the manufacturer warranty.

REQUIREMENTS:

**Before you begin, make sure you have an external, weatherproof, protected 110 volt outlet that meets GFCI (ground fault circuit interrupter) standards. Mount the LED Driver Box and Remote Control Driver Box 18 inches above the ground. Best results can be achieved when you have access to the underside of your deck or installation surface.**

CAUTION: Use eye protection when using power tools. Do not install more than the recommended deck lights on one driver box. Do not install within 10 feet of a pool, fountain or spa.

### Installation Instructions

Once all of the LED Deck lights have been connected to the wire, connect the male end of the twisted wire pigtail to the Remote Driver Box. Connect the Remote Control Driver wires to the end of the twisted wire using two connectors. The black wire must be connected to the positive wire lead as noted on the transformer, and the white wire must be connected to the negative wire. See Figure #1.

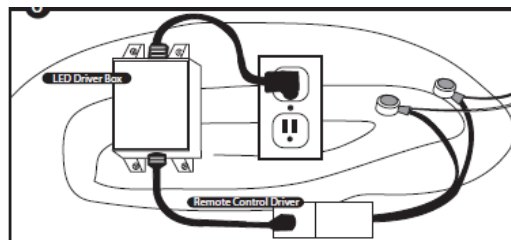



Figure #1

### Operating Instructions

There are 4 buttons on your remote control:

- M** = Mode button – allows for quick click adjustment
- Λ** = Micro adjust UP – Press and hold
- V** = Micro adjust DOWN – press and hold
- ⏻** = On/Off button



RF dimmer is a controller that can adjust light to the appropriate lighting brightness incrementally. Using the MODE button, click button to adjust from 100% - 70% - 35% - 5%. Pressing and holding the up/down arrow keys allows for micro adjustment between these increments. Pressing the MODE button again will bring the light back to previous increment. Press the  button to turn lights on/off.

---

### **Trouble shooting**

1. If your lights do not come on at all, check power to outlet, and inspect wiring system for damage, such as staple, nail, or screw piercing the wire.
2. Test the lights using the buttons on the Remote Control Driver Box.
3. Next, disconnect the Remote Control Driver Box from the Transformer, and connect the lights directly to the transformer.
4. Replace the battery in the handheld remote control with type MN27/A27 battery, 27A 12V.

### **Replacement Remote Controllers**

Your Remote Control handheld device is programmed to the frequency of the Remote Control Driver Box. In the event that you need to replace the handheld, follow the instructions below to reprogram the handheld device:

1. Check all connections on the transformer, Remote Control Driver Box, and lights. Confirm that power is on and lights are lit-up.
2. Unplug the transformer from outlet.
2. Press and hold both UP and DOWN arrow buttons on the handheld remote and simultaneously plug in the transformer. Continue to hold UP and DOWN arrow buttons for 15 seconds.
3. Release UP and DOWN arrow buttons. Press on/off button to activate.

The Aurora Deck Lighting Remote Control Dimmer is covered by a one year limited warranty. This product is warranted against defects in materials or workmanship as follows:

Units will be repaired or replaced, at our option, without charge for parts or labor for one year from date of purchase. Repairs and parts fees are the responsibility of the product owner after the indicated period of one year. The limited warranty cannot be transferred and is valid only for the original homeowner. It does not cover damage or failure caused by or attributable to natural disaster, abuse, misuse, improper or abnormal use, faulty installation, improper maintenance, lightning, or other incidences of excessive voltage, or any repairs or tampering by other than our Warranty Services Department. Products proven defective in workmanship or material are covered solely by the remedies of repair or replacement as provided by the terms of this warranty. Under no circumstances shall Aurora Deck Lighting be liable for any loss or damage, direct, or incidental, arising out of the use of or inability to use this product. Some states do not allow limitations on how long an implied warranty lasts or the exclusions or limitations of incidental or consequential damages, so the above limitations may not apply to product owners in certain states.

### Solutions<sup>™</sup> Rail Kit Contents and Dimensions

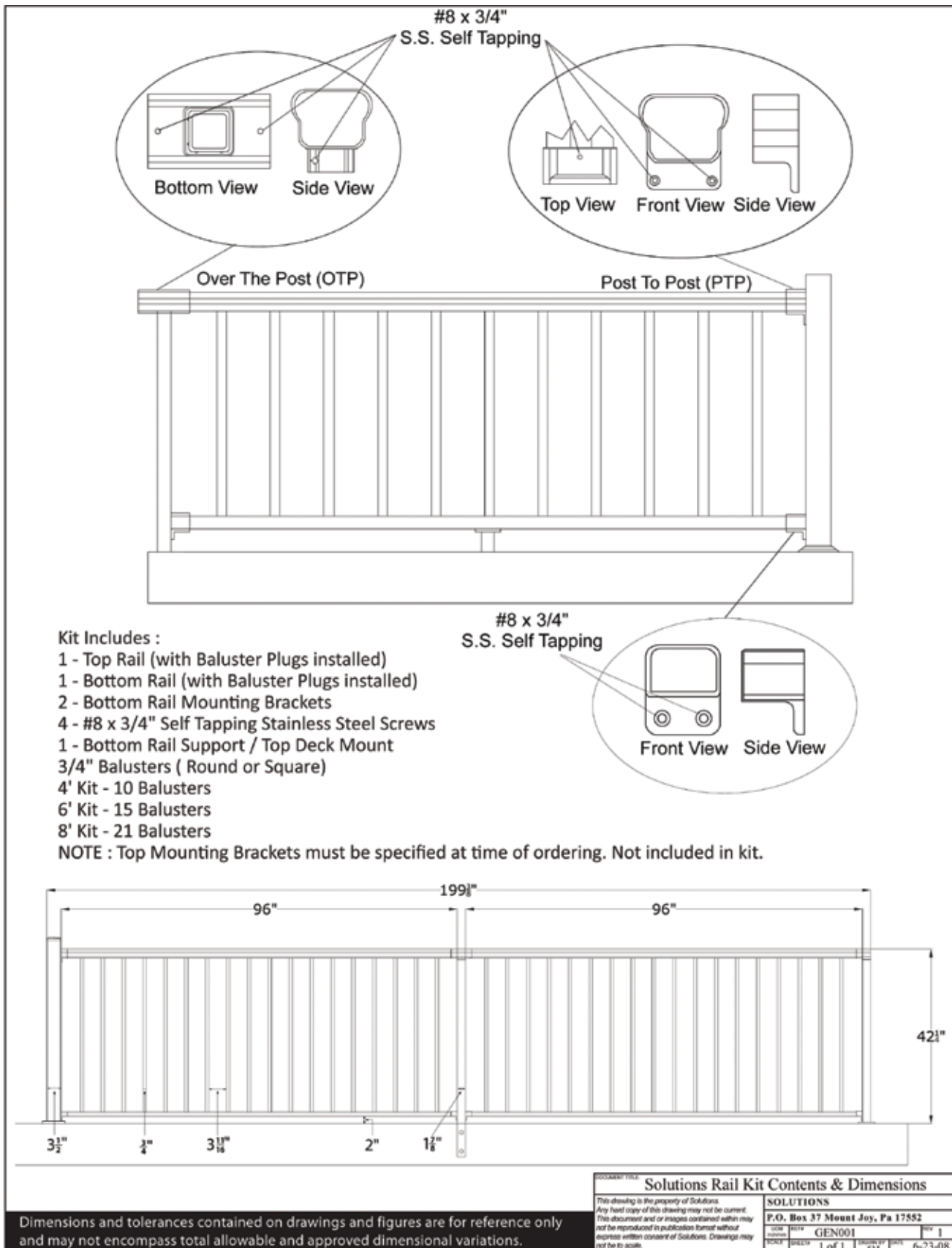

Dimensions and tolerances contained on drawings and figures are for reference only and may not encompass total allowable and approved dimensional variations.

ALUMINUM  
*Solutions*  
 RAIL SYSTEMS

**SOLUTIONS LIMITED WARRANTY**

Solutions [The Manufacturer] warrants its aluminum rail and handrail products subject to the terms, conditions and limitations listed herein, to be free from defective workmanship and materials, and when subject to normal and proper use, its powder coat finish is further warranted against surface peeling, flaking, or blisters for a period of 15 years for both residential and commercial applications.

**SOLUTIONS TERMS, CONDITIONS, AND LIMITATIONS**

1. The Manufacturer's sole liability and the owner's only remedy shall be as follows:
  - a. If a problem occurs, The Manufacturer, at its sole discretion, may elect either to repair or replace the defective part(s) of the railing or provide reimbursement limited to cost of materials at time of purchase. Due to normal aging and weathering of material, it may not be possible to perfectly match the colors of the old and new materials and therefore The Manufacturer is not responsible for any color differences that may occur. The Manufacturer is not responsible for discontinuance of a color.
2. The Manufacturer warrants only those products manufactured and sold under the Solutions name. This Limited Warranty extends only to the original purchaser according to terms specified herein. The Manufacturer shall not be liable for and this warranty does not apply to any terms, failure, defect or damage resulting from or connected with the following:
  - a. Defects not caused by The Manufacturer ( for example, but not limited to: accidents, misuse, improper applications or installations contrary to industry or Solutions standards)
  - b. Product that has been painted or had its surface treated or cleaned with other than approved chemicals
    - i. Refer to Solutions Care and Cleaning Guide
  - c. Product subject to impact of foreign objects, tornado, hurricane, other violent storms, fire, air pollutants, normal weathering of surfaces, abnormal discoloration due to improper maintenance, or any other acts of God
  - d. Improper installation of Solutions products or defects caused by their installation
  - e. Solutions Limited Warranty will not be applicable for products that are covered by a specific and separate warranty or duration
  - f. Products sold, shipped or installed outside of the Continental United States shall have a limited duration of this coverage to 10 years from date of purchase
3. This warranty does not include corrosion of screws and other fastening devices that may be used or required for specific application circumstances in the assembly or installation of the railing.
4. Should there be a defect in the system which limits the use of the railings The Manufacturer will not be responsible for or liable for loss of use of the railing or any consequential costs. The Manufacturer's only liability is for the repair or replacement of the defective part of the railing.
5. The Manufacturer will not be responsible for labor and material cost including removal, disposal and reinstallation of the warranted material.
6. The Manufacturer will not be required to honor this warranty
  - a. If the railing has been modified, altered or changed in any manner at time of installation or thereafter that is contrary to The Manufacturer's installation instructions.
  - b. The product was not installed to the most current, published standards which are available from The Manufacturer.
  - c. A representative has not been given a reasonable access to the property & opportunity to investigate any claim made.
  - d. If all bills for installation supplies and services have not been paid in full. Proof of purchase and payment in full must be presented to obtain warranty coverage.
  - e. If the Manufacturer's Care and Cleaning Guide have not been adhered to.
  - f. If the railing warranty has not been registered with The Manufacturer.
7. Any claim made under this warranty must be made within 30 days of the discovery of the problem. The claim must be made in writing to The Manufacturer or to the company responsible for the installation and must include a copy of the purchase contract.
8. To the extent allowed by the laws of each State or Province, the remedies provided under this warranty state the limits of The Manufacturer's responsibility. No representative has authority to make any representations other than those stated herein. Any and all disputes arising under the warranty whether as to interpretation, performance or otherwise, shall be subject to the exclusive jurisdiction of the courts of each State or Province.
9. This warranty is for the exclusive benefit of the original purchaser and is not assignable or transferable.
10. It is the responsibility of the Owner to maintain the railing in accordance with the current Care and Cleaning Guide on the reverse and as posted on the website at [www.solutionsrail.com](http://www.solutionsrail.com)
11. This warranty is offered by The Manufacturer. The Manufacturer is responsible for remedy of its affected materials relating to the problem. The undersigned Installation Company is responsible for the workmanship and will facilitate any necessary and related claims and repairs.
12. Warranty registration can be accomplished electronically by visiting [www.solutionsrail.com](http://www.solutionsrail.com) and registering within thirty (30) days of installation for eligibility of coverage under warranty terms. NOTE: PROOF OF PURCHASE IS NECESSARY TO EXERCISE CLAIMS AND REMEDIES FOR ANY OCCASION. PLEASE SAFEGUARD ACCORDINGLY. Upon receipt of all necessary information we will process and return a digital PDF copy of the warranty to the provided email address. If email is not available a hard copy will be mailed to the supplied building owner address.
13. The Installation Company guarantees that the work has been performed in accordance with the most current standards and specifications set out by The Manufacturer and is responsible for any workmanship related problems for a period of \_\_\_\_\_ years/months. The Installation Company may offer an additional written warranty stating the scope of their responsibility.

Product(s) Purchased \_\_\_\_\_ Date of Installation \_\_\_\_\_  
 Installation Company \_\_\_\_\_ Company Phone # \_\_\_\_\_  
 Company Address \_\_\_\_\_ Company Rep. Signature/Date \_\_\_\_\_ / \_\_\_\_\_  
 Building Owner's Name \_\_\_\_\_ Owner Phone # \_\_\_\_\_  
 Owner's Address \_\_\_\_\_ Owner Email \_\_\_\_\_  
 Dealer Where Purchased \_\_\_\_\_ Dealer Phone # \_\_\_\_\_  
 Dealer Address \_\_\_\_\_ Date of Purchase \_\_\_\_\_

[www.solutionsrail.com](http://www.solutionsrail.com)

ALUMINUM  
*Solutions*  
 RAIL SYSTEMS

**SOLUTIONS CARE & CLEANING GUIDE FOR ALUMINUM RAILING**

**Cleaning Guidelines:**

Proper maintenance and care of your Solutions Railing is critical to the long term appearance and protection of your investment. We recommend an occasional wash, every six (6) months, as the best way for this to be accomplished. Natural exposure to the elements, over time, will cause your railing to show signs of aging such as loss of gloss, chalking, or a slight color change. Your normal interval cleanings may minimize these natural effects of weathering by removing the dirt, grime and other build-up that is detrimental to the appearance of your Solutions Rail.

The manufacturer recommends an occasional wash of your Solutions Railing using a solution of warm water and a non-abrasive, pH neutral detergent. All surfaces should be thoroughly wetted prior to beginning the cleaning process. All surfaces should be cleaned using a soft white cloth, sponge or a soft bristle brush in conjunction with your water and detergent solution. Spot cleaning may be accomplished using Simple Green or Windex. All surfaces should then be thoroughly rinsed after the cleaning process to remove any and all residue that may be remaining. Any remaining residue may cause discoloration or surface damage when exposed to the elements. Additional care should be given if a pressure-washer is used, and in no case should you exceed 400 PSI.

**NOTES:**

- DO NOT use solvents, thinners or solutions containing chlorinated hydrocarbons, esters, or ketenes.
- DO NOT use abrasive cleaners
- DO NOT use steel wool, Scotch-Brite, sandpaper, or any other abrasive materials

The frequency and necessity of cleaning will depend on the environment and railing location. Due to the adverse affects to your Solutions Railing when it is not cleaned as suggested or the potential use of non-approved cleaners/detergents; we require these simple steps to maintain the manufacturer's warranty in force. These records may be requested in the unlikely event of a claim against the manufactures warranty.

1. Clean your Solutions Railing every 6 months
2. Write down your cleaning dates and schedule
3. Clean your Solutions Railing as outlined above
4. Write down notes of your cleaning methods and chemicals used
5. Maintain a copy of your commercial invoices for cleaning
6. Maintain a copy of your purchase receipts of the cleaners used

With proper care and maintenance the appearance of your Solutions Railing will last for years. Climate conditions affect the performance and cleanliness of painted aluminum in the same way as other coated materials. Installations in coastal regions, low rainfall areas, areas with heavy industry, periodic care and cleaning will be critical to maintain the durability and finish of your Solutions Railing.

Solutions Railing has been coated with an extremely durable surface meeting the AAMA 2604 specifications. As an added measure of protection and finish life you can periodically wax your railing just as you might your car. This process will remove any oxidized paint, bringing back the original color and shine of your system.

[www.solutionsrail.com](http://www.solutionsrail.com)





## Installation Instructions FortressAccents Premium Transformer (40W)

It is the responsibility of the installer to meet all code and safety requirements. The installer should determine and implement the appropriate installation techniques for each situation. The Fortress Company or its distributors shall not be held liable for improper or unsafe installations.

**WARNING – RISK OF ELECTRIC SHOCK.** Install power unit 10 feet (3.05 m) or more from a pool, spa, or fountain. Where the power unit is installed outdoors, connect power unit to a receptacle protected by a GFCI.

- **READ INSTALLATION INSTRUCTIONS BEFORE WIRING**
- **NOT FOR USE WITH EXTERNAL DIMMERS**
- **FOR OUTDOOR USE ONLY. MOUNT AT LEAST 12" (30.48 cm) ABOVE GROUND**
- **NOT FOR USE WITH SUBMERSIBLE FIXTURES**
- **DO NOT CONNECT TWO OR MORE TRANSFORMERS IN PARALLEL**

Required Materials: Phillips Head Screw Driver, Wire Cutters, Wire Strippers, Eye Protection, Tape Measure

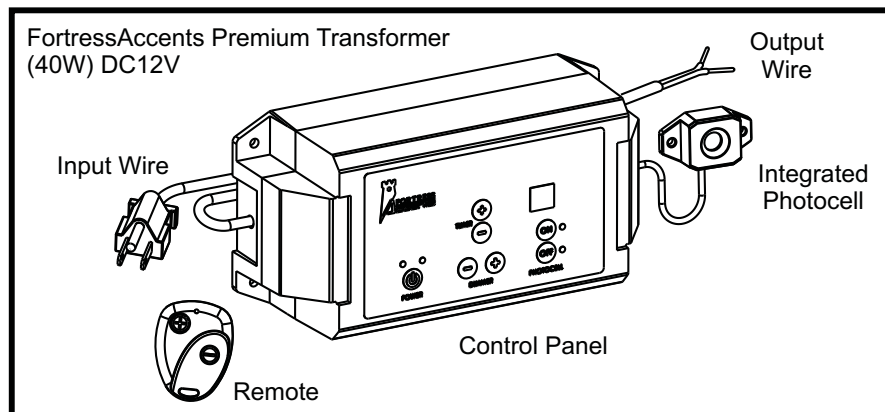

Transformer must be installed more than 12" (30.48 cm) above the ground.

Determine the best location for the transformer based on your lighting layout. Transformer should be located as close to the first luminaire as possible. Supplied input wire with plug must be connected to a GFCI protected outlet with a hooded flush type cover plate receptacle marked "Wet Location". **Do not to use an extension cord.**

If no GFCI protected outlet with a hooded flush type cover plate receptacle marked "Wet Location" is available, a licensed electrical contractor must install a GFCI outlet at the required location.

Mount Photocell to wall or other solid surface with supplied screws. Photocell should be mounted in a shade free location. Be sure not to mount photocell in a location that is influenced by nighttime lighting. Placement of photocell can be adjusted until the system comes on at the desired light level.

Run 18-2 gauge stranded outdoor wire by routing in close proximity to the luminaire or fitting, or next to a building structure such as a house or deck. Wire should not be buried.

Total wattage of lights in system should not exceed 40 watts. If additional lights are required a second transformer must be used. **Do not connect two or more transformers in parallel.**

Please visit [www.fortressaccents.com](http://www.fortressaccents.com) for information on how to order additional accessories.

### Control Panel

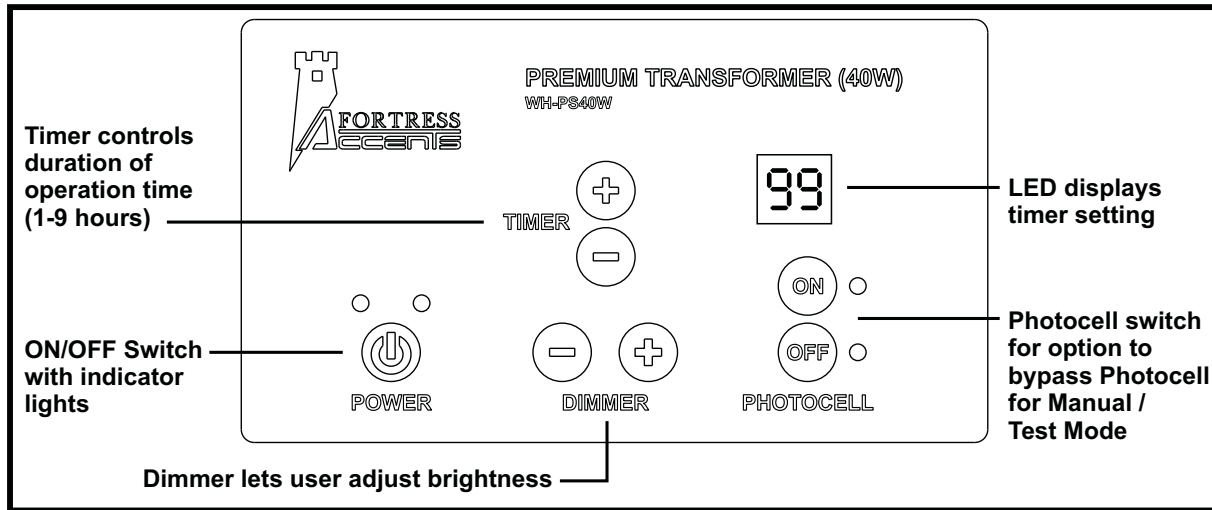

#### ON/OFF (Manual / Test Mode)

When power is "ON" green indicator light is illuminated

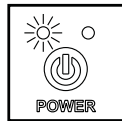

When power is "OFF" red indicator light is illuminated

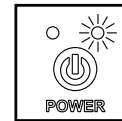

#### Timer and LED Display

In Manual / Test Mode with power "ON", default Timer setting will be displayed as 99.

In Photocell Mode, Timer can be set in 1 hour increments from 1 to 9 hours. Adjust timer by pressing the +/- buttons.

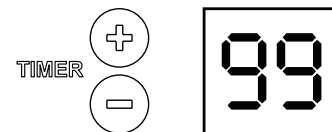

#### Photocell

Photocell ON/OFF allows user to bypass the Photocell to operate the Transformer in Manual / Test Mode. Photocell is "OFF" when red indicator light is illuminated. Photocell is "ON" when green indicator light is illuminated. **Photocell has a 2 minute delay.**

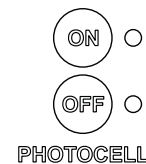

#### Dimmer

Dimmer provides user with control over brightness of all LED lights powered by the Premium Transformer (40W). Brightness can be incrementally changed by short pushes of the +/- buttons or hold +/- buttons for sliding adjustment. **FortressAccents LED Surface Mount Lights dim at different levels compared to other FortressAccents lighting components.**

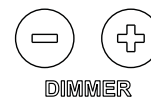

#### Remote (10 yard range)

Remote provides user with control over brightness of all LED lights powered by the Premium Transformer (40W). Brightness can be incrementally changed by short pushes of the +/- buttons or hold +/- buttons for sliding adjustment. **FortressAccents LED Surface Mount Lights dim at different levels compared to other FortressAccents lighting components.**





## Fortress AI<sup>13</sup> Aluminum Railing

### Limited Lifetime Warranty



Fortress Railing Products warrants its Fortress AI<sup>13</sup> Aluminum Railing products and accessories to be free from manufacturing defects in material and workmanship to the original consumer purchaser. In addition to manufacturing defects, this Limited Warranty covers cracking, peeling and blistering of the finish and extensive corrosion of the AI<sup>13</sup> Aluminum Railing products. Corrosion is termed extensive when there are multiple rust-through perforation instances on the same piece of product.

This warranty does not cover damage caused by abnormal or improper use, improper product application, accident, alteration, welding, neglect, abuse, lawn care equipment damage, abrasion, harsh chemicals, pool chemicals or chemicals for ice removal, air pollutants, improper service or installation or lack of service, or damage caused by flood, fire or acts of God. Surface corrosion from scratches, nicks and dents are not covered. For product located 1 mile or less from the coast line, this Limited Warranty is for a period of 3 years from the date of purchase. AI<sup>13</sup> Aluminum Railing products that have had direct contact with salt water are excluded from this limited warranty.

The original consumer purchaser must contact Fortress Railing Products' customer service directly via phone at (866) 323-4766 or via email at [warranties@fortressrailing.com](mailto:warranties@fortressrailing.com) to obtain necessary warranty claim forms and the official claim process. The original consumer purchaser will be notified by Fortress Railing Products as to whether the warranty claim is approved or denied. **PROOF OF PURCHASE TAG INCLUDED WITH ALL FORTRESS RAILING PRODUCTS AND ORIGINAL RECEIPT / INVOICE MUST ACCOMPANY ALL WARRANTY CLAIMS.**

#### Conditions and Exclusions of this warranty

THIS WARRANTY IS NOT TRANSFERABLE. THE AMOUNT OF YOUR RESTITUTION WILL NOT INCLUDE LABOR TO REMOVE EXISTING COMPONENTS OR INSTALL THE REPLACEMENT COMPONENTS, SHIPPING CHARGES, SALES TAX OR ANY OTHER CHARGES, NOR IS FORTRESS RAILING PRODUCTS REQUIRED TO PROVIDE SUCH LABOR OR SERVICE.

THIS LIMITED WARRANTY IS IN LIEU OF ALL OTHER EXPRESS WARRANTIES. FORTRESS RAILING PRODUCTS MAKES NO OTHER EXPRESS WARRANTIES AND DOES NOT AUTHORIZE ANY OTHER PERSON OR AGENT TO MAKE ANY OTHER EXPRESS WARRANTIES. FORTRESS RAILING PRODUCTS NEITHER ASSUMES NOR AUTHORIZES ANY OTHER LIABILITY OR OBLIGATION IN WARRANTY, INCLUDING WITHOUT LIMITATION, THE IMPLIED WARRANTIES OF MERCHANTABILITY AND FITNESS FOR A PARTICULAR PURPOSE WITH RESPECT TO THIS PRODUCT. IN NO EVENT SHALL FORTRESS RAILING PRODUCTS BE LIABLE FOR ANY CONSEQUENTIAL, SPECIAL, OR INCIDENTAL DAMAGES ARISING OUT OF OR CONNECTED WITH THE PURCHASE OR USE OF THIS PRODUCT OR FOR ANY BREACH OF WARRANTY.

This Agreement shall be governed by and construed in accordance with the laws of the State of Texas, without regard to its conflict of laws. Any legal action arising out of this Agreement shall be litigated and enforced under the laws of the State of Texas. In addition, you agree to submit to the jurisdiction of the courts of the State of Texas, and that any legal action pursued by you shall be within the exclusive jurisdiction of the courts in the State of Texas, U.S.A.

SOME STATES DO NOT ALLOW LIMITATIONS ON HOW LONG AN IMPLIED WARRANTY LASTS, OR THE EXCLUSION OR LIMITATION OF INCIDENTAL OR CONSEQUENTIAL DAMAGES, SO THE ABOVE LIMITATIONS OR EXCLUSION MAY NOT APPLY TO YOU. THIS WARRANTY GIVES YOU SPECIFIC LEGAL RIGHTS, AND YOU MAY HAVE OTHER RIGHTS THAT VARY FROM STATE TO STATE. THIS WARRANTY IS APPLICABLE ONLY TO SYSTEMS INSTALLED WITHIN THE CONTINENTAL UNITED STATES AND CANADA.





## Fortress Fe<sup>26</sup> Iron Railing

Protected by FortressShield  
**15 Year Limited Warranty**



Fortress Railing Products warrants its FortressShield protected Fe<sup>26</sup> Iron Railing products and accessories to be free from manufacturing defects in material and workmanship to the original consumer purchaser for a period of 15 years from the date of purchase. In addition to manufacturing defects, this Limited Warranty covers cracking, peeling and blistering of the finish and extensive corrosion of the Fe<sup>26</sup> Iron Railing products. Corrosion is termed extensive when there are multiple rust-through perforation instances on the same piece of product.

This warranty does not cover damage caused by abnormal or improper use, improper product application, accident, alteration, welding, neglect, abuse, lawn care equipment damage, abrasion, harsh chemicals, pool chemicals or chemicals for ice removal, air pollutants, improper service or installation or lack of service, or damage caused by flood, fire or acts of God. Surface corrosion from scratches, nicks and dents are not covered. For product located 1 mile or less from the coast line, this Limited Warranty is for a period of 1 year from the date of purchase. FortressShield protected Fe<sup>26</sup> Iron Railing products that have had direct contact with salt water are excluded from this limited warranty.

The original consumer purchaser must contact Fortress Railing Products' customer service directly via phone at (866) 323-4766 or via email at [warranties@fortressrailing.com](mailto:warranties@fortressrailing.com) to obtain necessary warranty claim forms and the official claim process. The original consumer purchaser will be notified by Fortress Railing Products as to whether the warranty claim is approved or denied. **PROOF OF PURCHASE TAG INCLUDED WITH ALL FORTRESS RAILING PRODUCTS AND ORIGINAL RECEIPT / INVOICE MUST ACCOMPANY ALL WARRANTY CLAIMS.**

### Conditions and Exclusions of this warranty

THIS WARRANTY IS NOT TRANSFERABLE. SOME DARKENING OF THE ANTIQUE BRONZE COLOR IS EXPECTED OVER TIME, AND THIS IS NOT A WARRANTY RELATED ISSUE. THE AMOUNT OF YOUR RESTITUTION WILL NOT INCLUDE LABOR TO REMOVE EXISTING COMPONENTS OR INSTALL THE REPLACEMENT COMPONENTS, SHIPPING CHARGES, SALES TAX OR ANY OTHER CHARGES, NOR IS FORTRESS RAILING PRODUCTS REQUIRED TO PROVIDE SUCH LABOR OR SERVICE.

THIS LIMITED WARRANTY IS IN LIEU OF ALL OTHER EXPRESS WARRANTIES. FORTRESS RAILING PRODUCTS MAKES NO OTHER EXPRESS WARRANTIES AND DOES NOT AUTHORIZE ANY OTHER PERSON OR AGENT TO MAKE ANY OTHER EXPRESS WARRANTIES. FORTRESS RAILING PRODUCTS NEITHER ASSUMES NOR AUTHORIZES ANY OTHER LIABILITY OR OBLIGATION IN WARRANTY, INCLUDING WITHOUT LIMITATION, THE IMPLIED WARRANTIES OF MERCHANTABILITY AND FITNESS FOR A PARTICULAR PURPOSE WITH RESPECT TO THIS PRODUCT. IN NO EVENT SHALL FORTRESS RAILING PRODUCTS BE LIABLE FOR ANY CONSEQUENTIAL, SPECIAL, OR INCIDENTAL DAMAGES ARISING OUT OF OR CONNECTED WITH THE PURCHASE OR USE OF THIS PRODUCT OR FOR ANY BREACH OF WARRANTY.

This Agreement shall be governed by and construed in accordance with the laws of the State of Texas, without regard to its conflict of laws. Any legal action arising out of this Agreement shall be litigated and enforced under the laws of the State of Texas. In addition, you agree to submit to the jurisdiction of the courts of the State of Texas, and that any legal action pursued by you shall be within the exclusive jurisdiction of the courts in the State of Texas, U.S.A.

SOME STATES DO NOT ALLOW LIMITATIONS ON HOW LONG AN IMPLIED WARRANTY LASTS, OR THE EXCLUSION OR LIMITATION OF INCIDENTAL OR CONSEQUENTIAL DAMAGES, SO THE ABOVE LIMITATIONS OR EXCLUSION MAY NOT APPLY TO YOU. THIS WARRANTY GIVES YOU SPECIFIC LEGAL RIGHTS, AND YOU MAY HAVE OTHER RIGHTS THAT VARY FROM STATE TO STATE. THIS WARRANTY IS APPLICABLE ONLY TO SYSTEMS INSTALLED WITHIN THE CONTINENTAL UNITED STATES AND CANADA.





## Fortress Railing Balusters

### 25 Year Limited Warranty



Fortress Railing Products warrants its balusters and baluster accessories to be free from manufacturing defects in material and workmanship to the original consumer purchaser for a period of 25 years from the date of purchase. In addition to manufacturing defects, this Limited Warranty covers cracking, peeling, and blistering of the finish and extensive corrosion of the baluster products. Corrosion is termed extensive when there are multiple rust-through perforation instances on the same piece of product.

This warranty does not cover damage caused by abnormal or improper use, improper product application, accident, alteration, welding, neglect, abuse, lawn care equipment damage, abrasion, harsh chemicals, pool chemicals or chemicals for ice removal, air pollutants, improper service or installation or lack of service, or damage caused by flood, fire or acts of God. Surface corrosion from scratches, nicks and dents are not covered. For product located 1 mile or less from the coast line, this Limited Warranty is for a period of 1 year from the date of purchase. This limited warranty does not cover balusters or baluster accessories that have had direct contact with salt water.

The original consumer purchaser must contact Fortress Railing Products' customer service directly via phone at (866) 323-4766 or via email at [warranties@fortressrailing.com](mailto:warranties@fortressrailing.com) to obtain necessary warranty claim forms and the official claim process. The original consumer purchaser will be notified by Fortress Railing Products as to whether the warranty claim is approved or denied. **PROOF OF PURCHASE TAG INCLUDED WITH ALL FORTRESS RAILING PRODUCTS AND ORIGINAL RECEIPT / INVOICE MUST ACCOMPANY ALL WARRANTY CLAIMS.**

#### Conditions and Exclusions of this warranty

THIS WARRANTY IS NOT TRANSFERABLE. SOME DARKENING OF THE ANTIQUE BRONZE COLOR IS EXPECTED OVER TIME, AND THIS IS NOT A WARRANTY RELATED ISSUE. THE AMOUNT OF YOUR RESTITUTION WILL NOT INCLUDE LABOR TO REMOVE EXISTING COMPONENTS OR INSTALL THE REPLACEMENT COMPONENTS, SHIPPING CHARGES, SALES TAX OR ANY OTHER CHARGES, NOR IS FORTRESS RAILING PRODUCTS™ REQUIRED TO PROVIDE SUCH LABOR OR SERVICE.

The following proration schedule applies to all Fortress Railing Balusters:

1 – 10 Years	100% Replacement
11 – 20 Years	75% Replacement
21 – 25 Years	50% Replacement

The original consumer purchaser will be responsible for paying any prorated costing.

THIS LIMITED WARRANTY IS IN LIEU OF ALL OTHER EXPRESS WARRANTIES. FORTRESS RAILING PRODUCTS™ MAKES NO OTHER EXPRESS WARRANTIES AND DOES NOT AUTHORIZE ANY OTHER PERSON OR AGENT TO MAKE ANY OTHER EXPRESS WARRANTIES. FORTRESS RAILING PRODUCTS™ NEITHER ASSUMES NOR AUTHORIZES ANY OTHER LIABILITY OR OBLIGATION IN WARRANTY, INCLUDING WITHOUT LIMITATION, THE IMPLIED WARRANTIES OF MERCHANTABILITY AND FITNESS FOR A PARTICULAR PURPOSE WITH RESPECT TO THIS PRODUCT. IN NO EVENT SHALL FORTRESS RAILING PRODUCTS BE LIABLE FOR ANY CONSEQUENTIAL, SPECIAL, OR INCIDENTAL DAMAGES ARISING OUT OF OR CONNECTED WITH THE PURCHASE OR USE OF THIS PRODUCT OR FOR ANY BREACH OF WARRANTY.

This Agreement shall be governed by and construed in accordance with the laws of the State of Texas, without regard to its conflict of laws. Any legal action arising out of this Agreement shall be litigated and enforced under the laws of the State of Texas. In addition, you agree to submit to the jurisdiction of the courts of the State of Texas, and that any legal action pursued by you shall be within the exclusive jurisdiction of the courts in the State of Texas, U.S.A.

SOME STATES DO NOT ALLOW LIMITATIONS ON HOW LONG AN IMPLIED WARRANTY LASTS, OR THE EXCLUSION OR LIMITATION OF INCIDENTAL OR CONSEQUENTIAL DAMAGES, SO THE ABOVE LIMITATIONS OR EXCLUSION MAY NOT APPLY TO YOU. THIS WARRANTY GIVES YOU SPECIFIC LEGAL RIGHTS, AND YOU MAY HAVE OTHER RIGHTS THAT VARY FROM STATE TO STATE. THIS WARRANTY IS APPLICABLE ONLY TO SYSTEMS INSTALLED WITHIN THE CONTINENTAL UNITED STATES AND CANADA.





## FortressAccents Post Caps & LED Lighting Limited Warranty



Fortress Railing Products warrants its FortressAccents products and accessories to be free from manufacturing defects in material and workmanship to the original consumer purchaser for the following time periods:

- Fixtures: 10 Years
- LED Components: 10 Years
- Transformers: 2 Years

In addition to manufacturing defects, this Limited Warranty covers cracking, peeling and blistering of the finish and extensive corrosion of the FortressAccents fixtures. Corrosion is termed extensive when there are multiple rust-through perforation instances on the same piece of product.

This warranty does not cover damage caused by abnormal or improper use, improper product application, accident, alteration, neglect, abuse, lawn care equipment damage, abrasion, harsh chemicals, pool chemicals or chemicals for ice removal, air pollutants, improper service or installation or lack of service, or damage caused by flood, fire or acts of God. Surface corrosion from scratches, nicks and dents are not covered. FortressAccents fixtures located 1 mile or less from the coast line, this Limited Warranty is for a period of 1 year from the date of purchase. FortressAccents fixtures that have had direct contact with salt water are excluded from this limited warranty.

The original consumer purchaser must contact Fortress Railing Products' customer service directly via phone at (866) 323-4766 or via email at [warranties@fortressrailing.com](mailto:warranties@fortressrailing.com) to obtain necessary warranty claim forms and the official claim process. The original consumer purchaser will be notified by Fortress Railing Products as to whether the warranty claim is approved or denied. **PROOF OF PURCHASE TAG INCLUDED WITH ALL FORTRESS RAILING PRODUCTS AND ORIGINAL RECEIPT / INVOICE MUST ACCOMPANY ALL WARRANTY CLAIMS.**

### Conditions and Exclusions of this warranty

THIS WARRANTY IS NOT TRANSFERABLE. SOME DARKENING OF THE ANTIQUE BRONZE COLOR IS EXPECTED OVER TIME, AND THIS IS NOT A WARRANTY RELATED ISSUE. THE AMOUNT OF YOUR RESTITUTION WILL NOT INCLUDE LABOR TO REMOVE EXISTING COMPONENTS OR INSTALL THE REPLACEMENT COMPONENTS, SHIPPING CHARGES, SALES TAX OR ANY OTHER CHARGES, NOR IS FORTRESS RAILING PRODUCTS REQUIRED TO PROVIDE SUCH LABOR OR SERVICE.

THIS LIMITED WARRANTY IS IN LIEU OF ALL OTHER EXPRESS WARRANTIES. FORTRESS RAILING PRODUCTS MAKES NO OTHER EXPRESS WARRANTIES AND DOES NOT AUTHORIZE ANY OTHER PERSON OR AGENT TO MAKE ANY OTHER EXPRESS WARRANTIES. FORTRESS RAILING PRODUCTS NEITHER ASSUMES NOR AUTHORIZES ANY OTHER LIABILITY OR OBLIGATION IN WARRANTY, INCLUDING WITHOUT LIMITATION, THE IMPLIED WARRANTIES OF MERCHANTABILITY AND FITNESS FOR A PARTICULAR PURPOSE WITH RESPECT TO THIS PRODUCT. IN NO EVENT SHALL FORTRESS RAILING PRODUCTS BE LIABLE FOR ANY CONSEQUENTIAL, SPECIAL, OR INCIDENTAL DAMAGES ARISING OUT OF OR CONNECTED WITH THE PURCHASE OR USE OF THIS PRODUCT OR FOR ANY BREACH OF WARRANTY.

This Agreement shall be governed by and construed in accordance with the laws of the State of Texas, without regard to its conflict of laws. Any legal action arising out of this Agreement shall be litigated and enforced under the laws of the State of Texas. In addition, you agree to submit to the jurisdiction of the courts of the State of Texas, and that any legal action pursued by you shall be within the exclusive jurisdiction of the courts in the State of Texas, U.S.A.

SOME STATES DO NOT ALLOW LIMITATIONS ON HOW LONG AN IMPLIED WARRANTY LASTS, OR THE EXCLUSION OR LIMITATION OF INCIDENTAL OR CONSEQUENTIAL DAMAGES, SO THE ABOVE LIMITATIONS OR EXCLUSION MAY NOT APPLY TO YOU. THIS WARRANTY GIVES YOU SPECIFIC LEGAL RIGHTS, AND YOU MAY HAVE OTHER RIGHTS THAT VARY FROM STATE TO STATE. THIS WARRANTY IS APPLICABLE ONLY TO SYSTEMS INSTALLED WITHIN THE CONTINENTAL UNITED STATES AND CANADA.



Please note: Quick Quote forms may be emailed or faxed upon request



## Quick Quote

### Fax to 800-203-4495



Absolute Distribution Inc.  
800-335-5909

---

### Solutions LEVEL Guard Rail Planning Guide

**STEP 1 COLOR:**  
 White       Black       Bronze

**STEP 2 GUARD RAIL HEIGHT:**  
 Residential (36")       Commercial (42")

**STEP 4 BALUSTER STYLE:**  
 Round       Square       Glass

**STEP 5 MOUNTING STYLE:**  
 Surface Mount       Side/Fascia Mount (1 7/8" Post Only)

**STEP 6 POST SIZE:**  
 4" Sleeve Over (Post To Post)       3-1/2" Post Sleeve (Post To Post)       3-1/2" Flanged Post (Post To Post)       1-7/8" Post Sleeve (Over The Post)   
Sleeves Over Nominal 4" x 4" Post

**STEP 7 USE GRID ON BACK TO DRAW DECK OR PORCH AREA**  
 Reference sketch of deck with posts and rail sections. Count all rail sections and enter quantities below.

**STEP 8 LIST NUMBER OF ITEMS REQUIRED TO COMPLETE PROJECT FROM SKETCH ON BACK OF SHEET:**  
 For rail sections shorter than standard length go to the next longer rail kit - will need to be cut down. **(Use rail sections no longer than 8' in length)**  
 Count all posts and enter quantities below **(Note: If mixings post sizes enter quantities on two lines)**. For each rail section select top rail brackets based on Post to Rail Configuration - 1 Set of brackets for each rail section (kit) (Note: Bottom brackets are supplied in kits).

**RAILING SECTIONS**  
 4' \_\_\_\_\_      6' \_\_\_\_\_      8' \_\_\_\_\_

**POSTS AND POST ACCESSORIES:**  
 Posts \_\_\_\_\_      Post Size \_\_\_\_\_      Post Mounts \_\_\_\_\_  
 Posts \_\_\_\_\_      Post Size \_\_\_\_\_      Post Mounts \_\_\_\_\_  
 Post Trim \_\_\_\_\_      Post Caps \_\_\_\_\_  
 Post Trim \_\_\_\_\_      Post Caps \_\_\_\_\_

**POST TO POST CONNECTOR BRACKETS:**  
 Top Rail Bracket (2/pk) \_\_\_\_\_      Top Rail "Multi-Angle" Bracket \_\_\_\_\_

**OVER THE POST CONNECTOR BRACKETS: (NOTE: 1 PAIR PER SECTION)**  
 Top Rail End Bracket \_\_\_\_\_      Top Rail 90° Bracket \_\_\_\_\_  
 Top Rail Line Bracket \_\_\_\_\_      Top Rail T Bracket \_\_\_\_\_  
 Top Rail "Multi-Angle" Bracket \_\_\_\_\_      Bottom Rail "Multi-Angle" Bracket \_\_\_\_\_

**STEP 3 POST TO RAIL CONFIGURATION:**



POST TO POST



OVER THE POST

Contact: \_\_\_\_\_  
 Phone: \_\_\_\_\_  
 Company: \_\_\_\_\_

Please send a sketch with dimensions

Please note: Quick Quote forms may be emailed or faxed upon request



## Quick Quote Fax to 800-203-4495



### Solutions STAIR Guard Rail Planning Guide

**STEP 1 COLOR:**  
White  Black  Bronze

**STEP 2 GUARD RAIL HEIGHT:**  
Residential (36")  Commercial (42")

**STEP 4 BALUSTER STYLE:**  
Round  Square  Glass

**STEP 5 MOUNTING STYLE:**  
Surface Mount  Side/Fascia Mount (1 7/8" Post Only)

**STEP 6 POST SIZE:**  
4" Sleeve Over (Post To Post)  3-1/2" Post Sleeve (Post To Post)  3-1/2" Flanged Post (Post To Post)  1-7/8" Post Sleeve (Over The Post)   
Sleeves Over Nominal 4" x 4" Post

**STEP 7 USE GRID ON BACK TO DRAW DECK OR PORCH AREA**  
Reference sketch of deck with posts and rail sections. Count all rail sections and enter quantities below.

**STEP 8 LIST NUMBER OF ITEMS REQUIRED TO COMPLETE PROJECT FROM SKETCH ON BACK OF SHEET:**  
For rail sections shorter than standard length go to the next longer rail kit - will need to be cut down. **(Use rail sections no longer than 8' in length)**  
Count all posts and enter quantities below **(Note: If mixing post sizes enter quantities on two lines)**. For each rail section select top rail brackets based on Post to Rail Configuration - 1 Set of brackets for each rail section (kit) (Note: Bottom brackets are supplied in kits).

**RAILING SECTIONS**

4' \_\_\_\_\_ 6' \_\_\_\_\_ 8' \_\_\_\_\_

**POSTS AND POST ACCESSORIES:**

Posts \_\_\_\_\_ Post Size \_\_\_\_\_ Post Mounts \_\_\_\_\_  
Posts \_\_\_\_\_ Post Size \_\_\_\_\_ Post Mounts \_\_\_\_\_  
Post Trim \_\_\_\_\_ Post Caps \_\_\_\_\_  
Post Trim \_\_\_\_\_ Post Caps \_\_\_\_\_

**POST TO POST CONNECTOR BRACKETS:**

Top Rail "Multi-Pitch" Bracket (2/pk) \_\_\_\_\_  
30" - 34" Top Rail "Fixed-Pitch" Bracket (2/pk) \_\_\_\_\_

**OVER THE POST CONNECTOR BRACKETS: (NOTE: 1 PAIR PER SECTION)**

Top Rail "Multi-Pitch" Line Bracket \_\_\_\_\_ Top Rail "Multi-Pitch" End Bracket \_\_\_\_\_  
Top Rail "Multi-Pitch" End Cap \_\_\_\_\_ Bottom Rail "Multi-Pitch" Bracket (2/pk) \_\_\_\_\_  
Bottom Rail "Fixed-Pitch" Bracket (2/pk) \_\_\_\_\_

Contact: \_\_\_\_\_  
Phone: \_\_\_\_\_  
Company: \_\_\_\_\_

Please send a sketch with dimensions

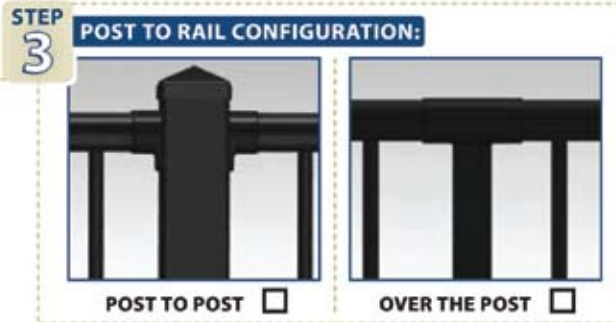

**Top Rail Brackets (PTP or OTP) Sold Separately**



Installation Information and FAQ's Solutions™



Please note: Quick Quote forms may be emailed or faxed upon request



## Secondary Hand Rail Planning Guide

### Quick Quote

Fax to 800-203-4495



Contact: \_\_\_\_\_  
Phone: \_\_\_\_\_  
Company: \_\_\_\_\_

**HAND RAIL:**

- White
- Bronze
- Black

- |                                     |       |                                       |       |
|-------------------------------------|-------|---------------------------------------|-------|
| A - 90° Elbow                       | _____ | I - 90° Angle Rail                    | _____ |
| B - 2-5/16" Spacer Tube             | _____ | J - P-Loop Return Angle               | _____ |
| C - Straight Bracket Rail Connector | _____ | K - 8' Straight Handrail              | _____ |
| D - Universal Angle Rail Connector  | _____ | L - Quick Return Kit 1-7/8" Post      | _____ |
| E - End Cap                         | _____ | M - Quick Return Kit 3-1/2" Post      | _____ |
| F - 5° Angle Rail                   | _____ | N - Quick Return Kit - Wall Mount     | _____ |
| G - 32° Angle Rail                  | _____ | O - Mid-Rail Bracket Kit 1-7/8" Post  | _____ |
| H - 38° Angle Rail                  | _____ | P - Mid-Rail Bracket Kit 3-1/2" Post  | _____ |
|                                     |       | Q - Mid-Rail Bracket Kit - Wall Mount | _____ |

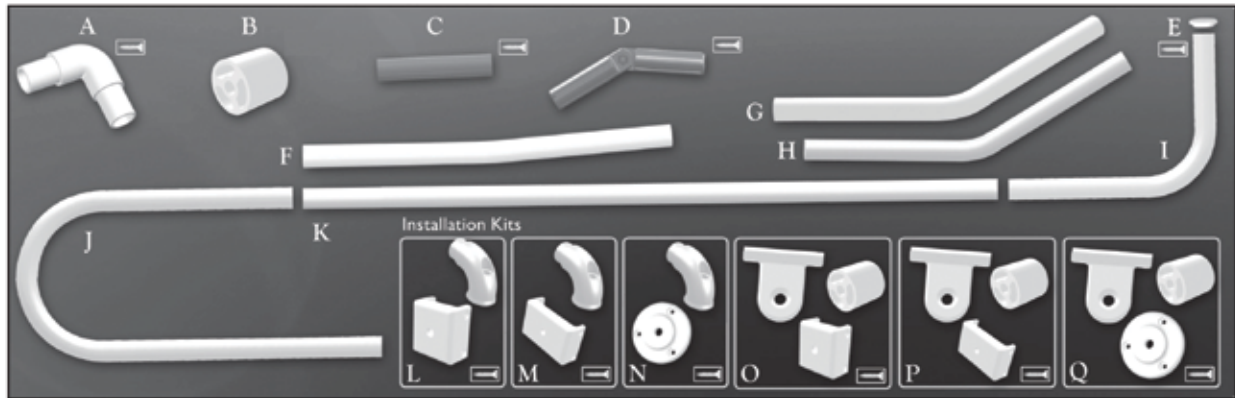

NOTES:

-----

-----

Use space above to draw deck or porch area referencing your request or send a sketch with Quick Quote Fax form.

Please note: Quick Quote forms may be emailed or faxed upon request



**Quick Quote**  
Fax to 800-203-4495



**Cable Railing Deck Planning Guide**

**STEP 1**

**POST MATERIAL TYPE :**

Wood  Composite  Sleeved   
Post Size \_\_\_\_\_ Sleeve Size \_\_\_\_\_

Contact: \_\_\_\_\_  
Dealer: \_\_\_\_\_  
Phone: \_\_\_\_\_  
Email: \_\_\_\_\_

**STEP 2**

**RAIL HEIGHT :**

36" Height  42" Height  Other - \_\_\_\_\_

**STEP 3**

**POST CONFIGURATIONS :**

Limited Access or Obstructed Post  Corner Posts   
Under 3"  Over 3"  Single Post  Double Post

**STEP 4**

**STAIRS :**

Yes  No  Length - \_\_\_\_\_

**STEP 5**

**LINEALS :**

Top Lineal  Bottom Lineal  Size of Lines \_\_\_\_\_  
Yes  (Required) Yes  No

**STEP 6**

**USE GRID BELOW TO DRAW DECK OR PORCH AREA:**

Reference sketch of deck with posts and rail sections.  
Note: Cable will be spaced with 3" centers. Cables must be supported at 42" or less to avoid deflection (supports not provided).

