

DekPro™ Prestige Railing

Horizontal Baluster Railing System

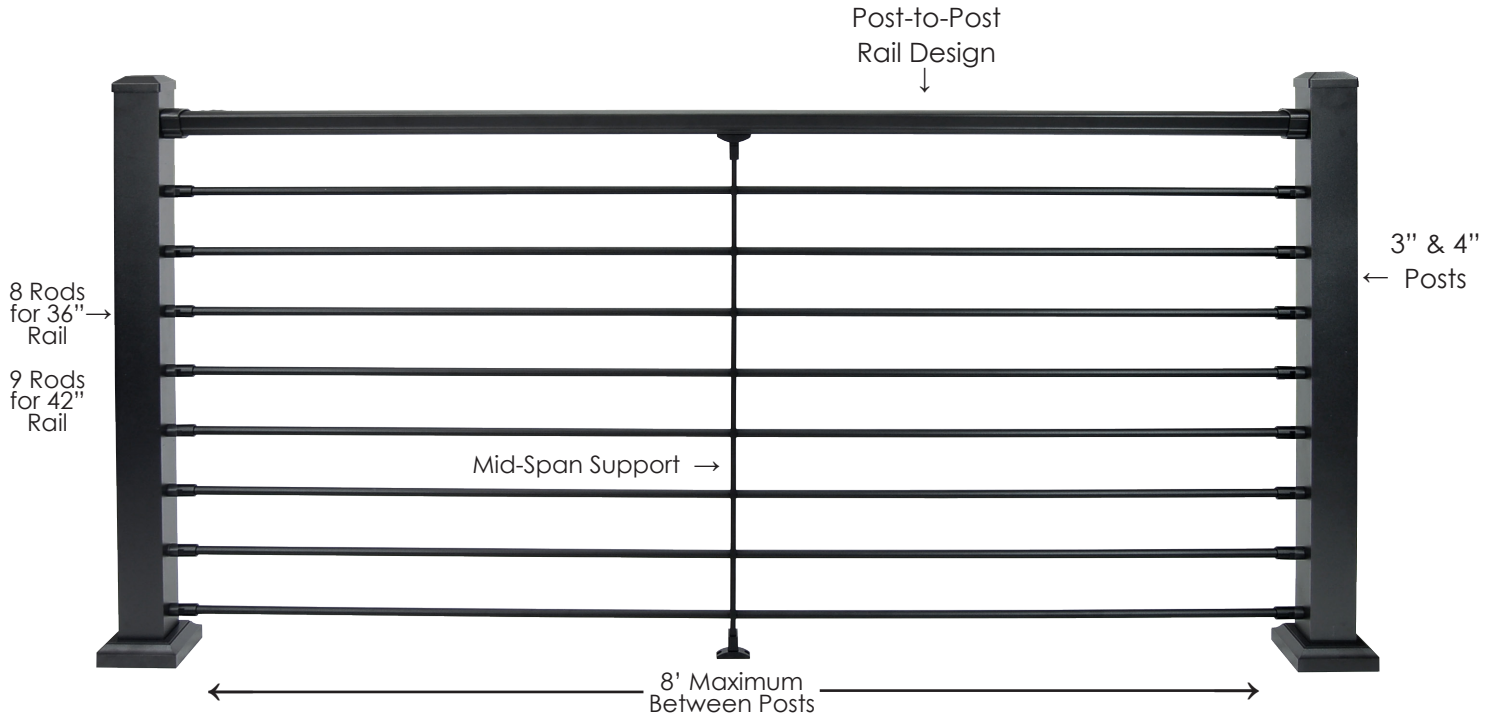

- Sleek, Modern Design
- 6' and 8' Lengths
- Field Trimmable to Length
- Level and Stair Railings

- 36" and 42" Rail Heights
- Easy Installation
- 5/8" Diameter Rods

Available Baluster Colors:



Black Textured



Anodized

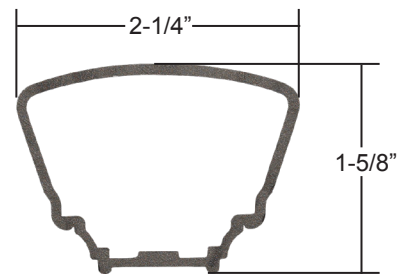

3 Part Selection Process

Posts

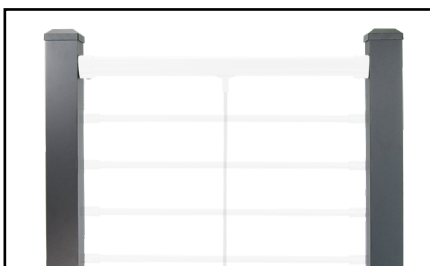

Top Rail / Brackets



Baluster Kits

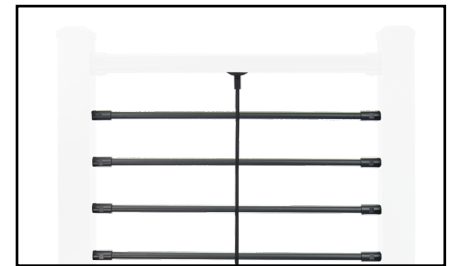

ACTUAL FREIGHT CHARGES APPLY TO DEKPROTM PRESTIGE RAIL ORDERS

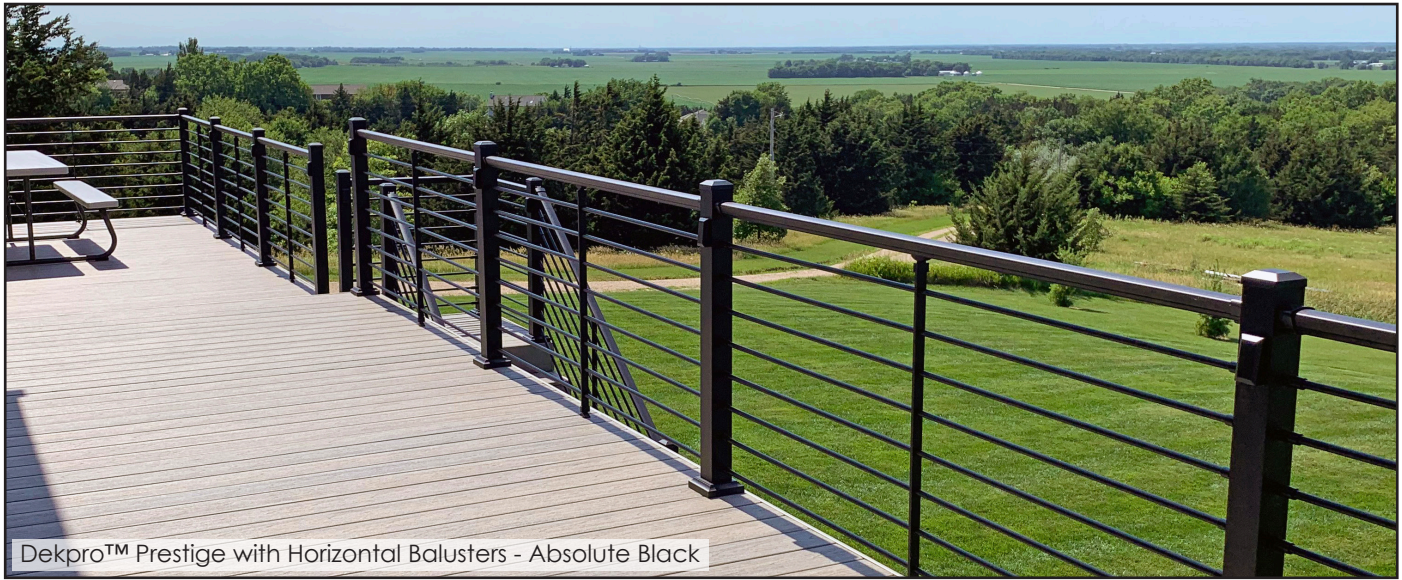

DekproTM Prestige with Horizontal Balusters - Absolute Black

Horizontal Baluster Kits for DekProTM Prestige



Available in:
 Black Text
 Anodized

Level - Horizontal Baluster Infill Kits (8 Rods)

Sold in any quantity.

Horizontal baluster infill kits include 8 rods and all necessary components to complete this infill option for a 36" rail height. For 42" rail height an additional baluster will be required (9 total) - see page 185. for additional balusters and connectors - sold separately.

6' Rail Kit (5/8" x 72")

Item # 203061 - Black Textured
 Item # 203060 - Anodized

8' Rail Kit (5/8" x 96")

Item # 203065 - Black Textured
 Item # 203064 - Anodized

Level Kit Includes:

- A. 8 - 5/8" Diameter Horizontal Balusters
- B. 16 - Level Horizontal Baluster Connectors w/ Fasteners
- C. 1 - Mid-Rail Support
- D. 2 - Mid-Rail Support Connector Shoes w/ Fasteners

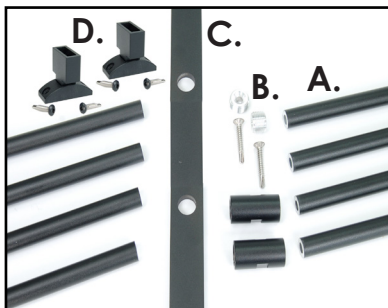

Post Jig

Sold in any quantity.

Quick Jig rail guide allows the installer to easily locate and fasten top rail bracket as well as locate horizontal baluster railing without having to measure or center manually.
Fits 3" post, but can be used on 4" post if reversed (2-way level may have to be removed for 4" post)

Item # PRJIG3RR - 3" post jig for rod rail



ACTUAL FREIGHT CHARGES APPLY TO DEKPROTM PRESTIGE RAIL ORDERS



DekproTM Prestige with Horizontal Balusters - Anodized Rods

Horizontal Baluster Kits for DekProTM Prestige

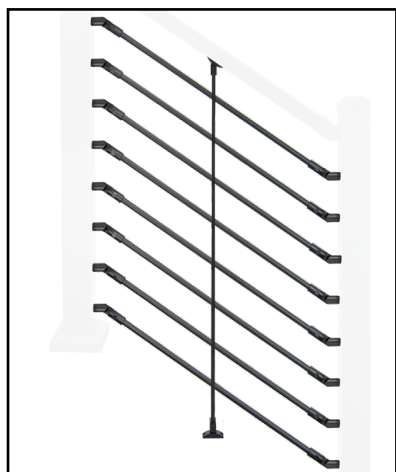

Available in:

 Black Text

 Anodized

Stair - Horizontal Baluster Infill Kits (8 Rods)

Sold in any quantity.

Stair horizontal baluster infill kits include 8 rods and all necessary components to complete this infill option for a 36" rail height. For 42" rail height an additional baluster will be required (9 total) - see next page for additional balusters and connectors - sold separately. Adjustable up to 40 degree angle.

6' Rail Kit (5/8" x 72")

Item # 203063 - Black Textured

Item # 203062 - Anodized

8' Rail Kit (5/8" x 96")

Item # 203067 - Black Textured

Item # 203066 - Anodized

Stair Kit Includes:

- A. 8 - 5/8" Diameter Horizontal Balusters
- B. 16 - Stair Horizontal Baluster Connectors w/ Fasteners
- C. 1 - Mid-Rail Support
- D. 2 - Mid-Rail Support Connector Shoes w/ Fasteners

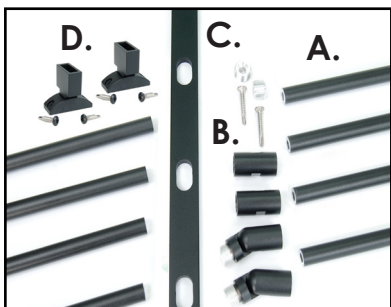

ACTUAL FREIGHT CHARGES APPLY TO DEKPROTM PRESTIGE RAIL ORDERS

Horizontal Rail Components



Available in:

Black Text

Anodized

Individual Horizontal Baluster

Sold in any quantity.

5/8" Diameter horizontal baluster available in 6' and 8' lengths. Used with level and/or stairs. Commonly used with the kits to accommodate a 42" rail height. Requires connectors for attachment (see below).

6' Baluster (72")

Item # 203002 - Black Textured
Item # 203000 - Anodized

8' Baluster (96")

Item # 203003 - Black Textured
Item # 203001 - Anodized



Available in:

Black Text

Anodized

Horizontal Baluster Connector - Level

Sold in pairs.

For attaching level horizontal balusters to posts.

Level:

Item # 203004 - Black Textured
Item # 203005 - Anodized

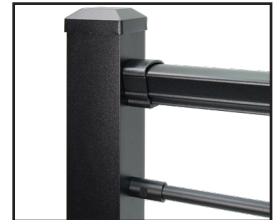

Available in:

Black Text

Anodized

Horizontal Baluster Connector - Stair/Multi-Angle

Sold in pairs.

For attaching angled horizontal balusters to posts. Most commonly used for stair but also accommodates side to side multi-angles. Adjustable up to 40 degree angle.

Must use with level connector (see above).

Angle:

Item # 203006 - Black Textured
Item # 203007 - Anodized

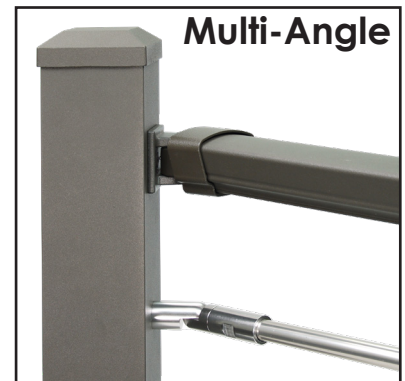
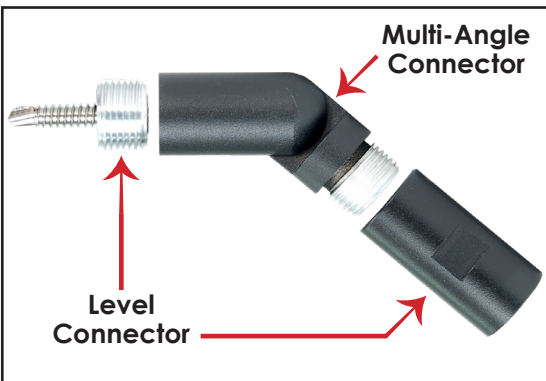

ACTUAL FREIGHT CHARGES APPLY TO DEKPROTM PRESTIGE RAIL ORDERS

Horizontal Rail Components

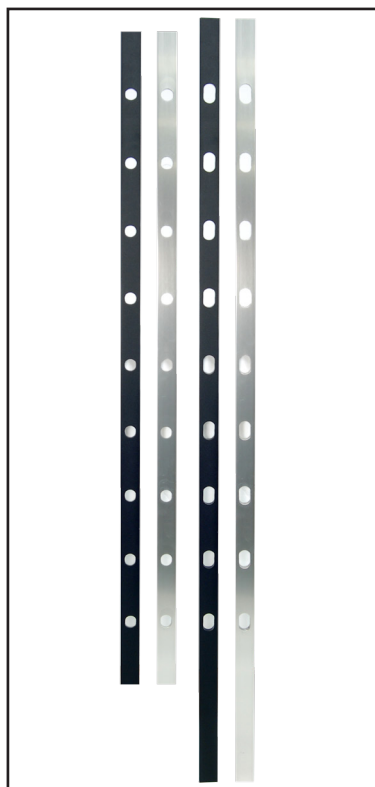

Available in:

Black Text

Anodized

Horizontal Rail Mid-Rail Support - REPLACEMENT

Sold in any quantity.

Horizontal rail mid-rail support is used with railing sections over 4' wide as a center support to keep balusters from flexing over 4". Each support comes with 10 set screws and 2 attachment shoes with fasteners. Supports need to be cut to length on site.

Level Support

Item # 203008 - Black Textured

Item # 203009 - Anodized

Stair Support

Item # 203010 - Black Textured

Item # 203011 - Anodized



Included

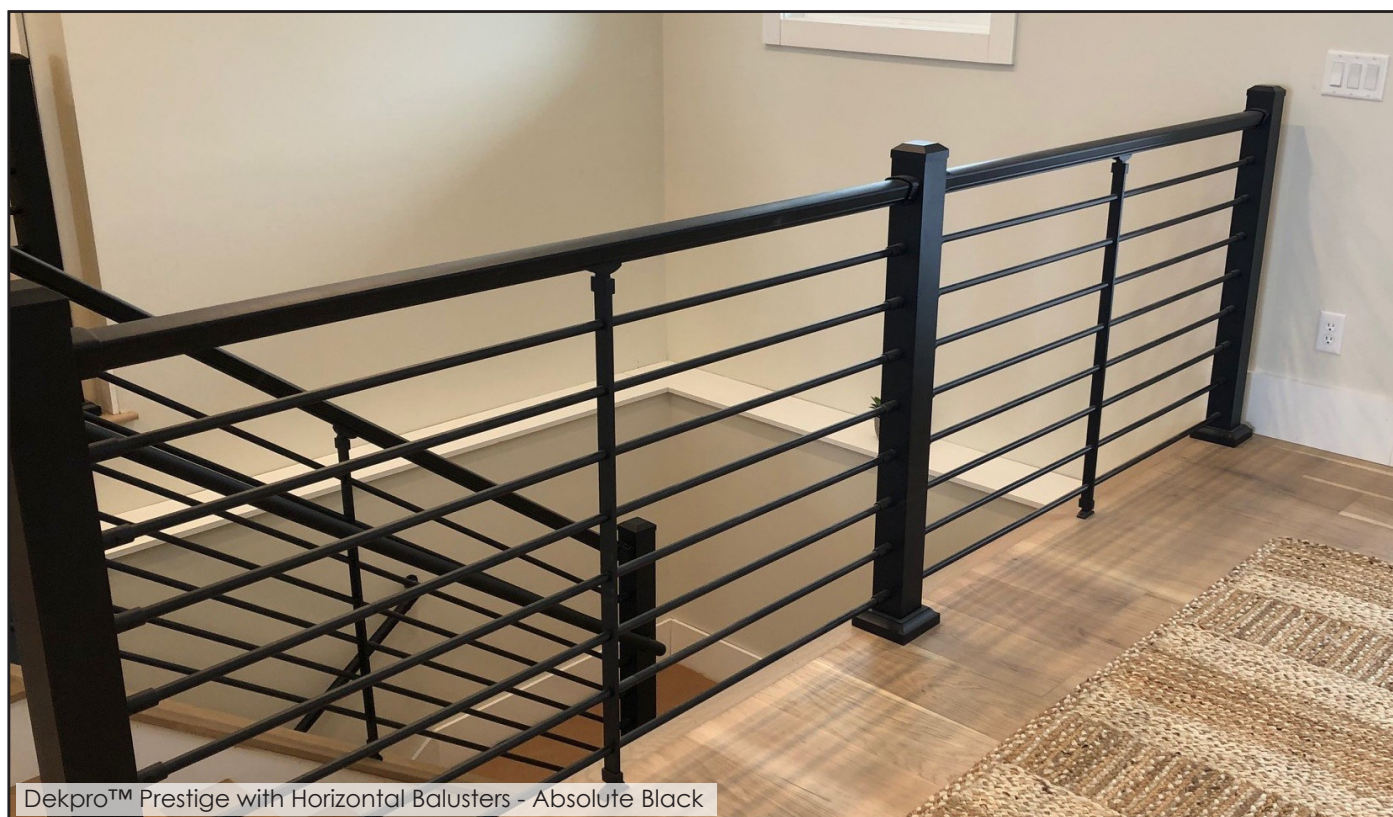

DekproTM Prestige with Horizontal Balusters - Absolute Black

ACTUAL FREIGHT CHARGES APPLY TO DEKPRO™ PRESTIGE RAIL ORDERS

Posts and Post Sleeves (Textured)

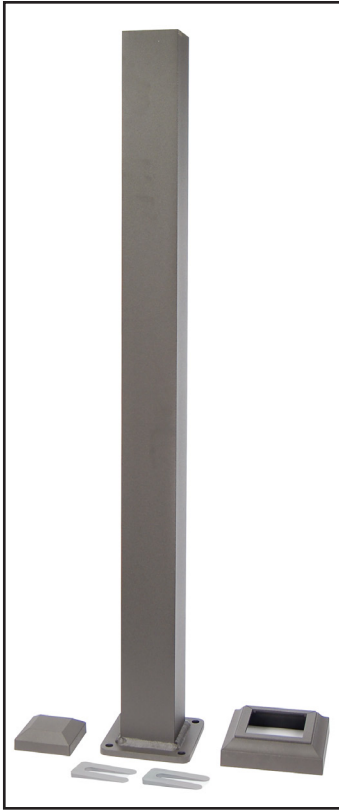

Available in:

- Absolute Black
- Cocoa Bronze
- Dream White

3" Aluminum Post w/ Post Cap and Skirt

Sold in any quantity.

3" Aluminum post with 5" welded flange. Base plate is 3/8" thick with 3/8" holes spaced 4" on center for fasteners. Post skirt measure 5-3/8".
Post cap and 2 piece skirt & tapered shims included.

3" x 40"

- Item # PR3040POSTABT - Black
- Item # PR3040POSTCBT - Bronze
- Item # PR3040POSTDWT - White

3" x 54"

- Item # PR3054POSTABT - Black
- Item # PR3054POSTCBT - Bronze
- Item # PR3054POSTDWT - White

3" x 44"

- Item # PR3044POSTABT - Black
- Item # PR3044POSTCBT - Bronze
- Item # PR3044POSTDWT - White

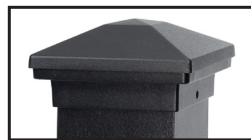

3" Pyramid Post Cap - Upgrade

- Item # DPPC3PABT - Absolute Black
- Item # DPPC3PCBT - Cocoa Bronze
- Item # DPPC3PDWT - Dream White

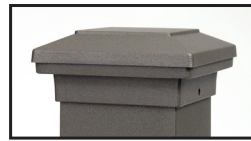

3" Flat Top Post Cap - Upgrade

- Item # DPPC3FABT - Absolute Black
- Item # DPPC3FCBT - Cocoa Bronze
- Item # DPPC3FDWT - Dream White

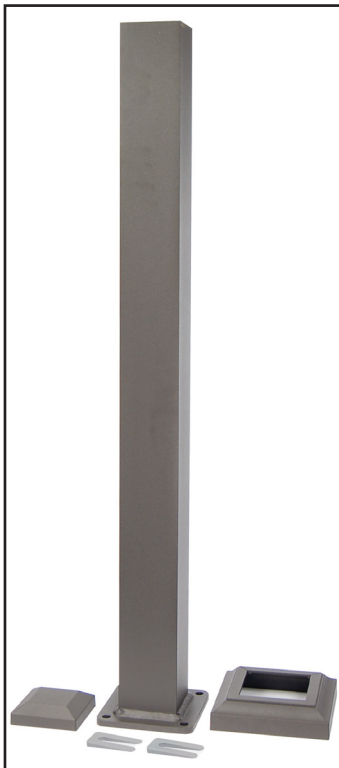

Available in:

- Absolute Black
- Cocoa Bronze
- Dream White

4" Aluminum Post w/ Cap and Skirt

Sold in any quantity.

4" Aluminum post with 6" welded flange. Base plate is 3/8" thick with 3/8" holes spaced 5" on center for fasteners. Post skirt measure 6-3/4".
Post cap and 2 piece skirt & tapered shims included.

4" x 40"

- Item # PR4040POSTABT - Black
- Item # PR4040POSTCBT - Bronze
- Item # PR4040POSTDWT - White

4" x 54"

- Item # PR4054POSTABT - Black
- Item # PR4054POSTCBT - Bronze
- Item # PR4054POSTDWT - White

4" x 44"

- Item # PR4044POSTABT - Black
- Item # PR4044POSTCBT - Bronze
- Item # PR4044POSTDWT - White



4" Pyramid Post Cap - Upgrade

- Item # DPPC4PABT - Absolute Black
- Item # DPPC4PCBT - Cocoa Bronze
- Item # DPPC4PDWT - Dream White

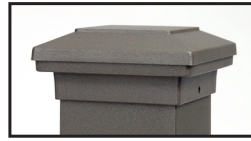

4" Flat Top Post Cap - Upgrade

- Item # DPPC4FABT - Absolute Black
- Item # DPPC4FCBT - Cocoa Bronze
- Item # DPPC4FDWT - Dream White

ACTUAL FREIGHT CHARGES APPLY TO DEKPRO™ PRESTIGE RAIL ORDERS

Post Jig and Caps (Textured)

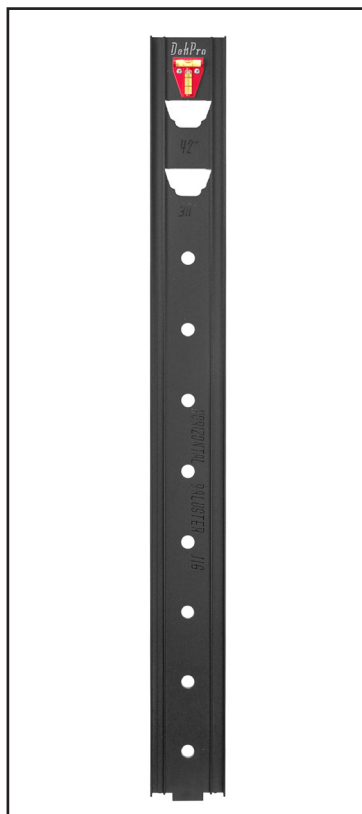

Available in:

 Black



Quick Jig Rail Guide - For Level Railing

Sold in any quantity.

Quick Jig rail guide allows the installer to easily locate and fasten top rail bracket as well as locate horizontal baluster railing without having to measure or center manually.
Fits 3" post, but can be used on 4" post if reversed (2-way level may have to be removed for 4" post)

Item # PRJIG3RR - 3" post jig for rod rail



Available in:
 Absolute Black
 Cocoa Bronze
 Dream White

Summit - Pyramid Post Cap - OPTIONAL

Sold in any quantity.

Aluminum pyramid post cap with fine textured powder coat finish.

3" Cap

Item # DPPC3PABT - Absolute Black
Item # DPPC3PCBT - Cocoa Bronze
Item # DPPC3PDWT - Dream White

4" Cap

Item # DPPC4PABT - Absolute Black
Item # DPPC4PCBT - Cocoa Bronze
Item # DPPC4PDWT - Dream White

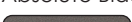

Available in:
 Absolute Black
 Cocoa Bronze
 Dream White

Plateau - Flat Top Post Cap - OPTIONAL

Sold in any quantity.

Aluminum flat top post cap with fine textured powder coat finish.

3" Cap

Item # DPPC3FABT - Absolute Black
Item # DPPC3FCBT - Cocoa Bronze
Item # DPPC3FDWT - Dream White

4" Cap

Item # DPPC4FABT - Absolute Black
Item # DPPC4FCBT - Cocoa Bronze
Item # DPPC4FDWT - Dream White

ACTUAL FREIGHT CHARGES APPLY TO DEKPROTM PRESTIGE RAIL ORDERS

Top Rail and Brackets (Textured)



Available in:

Absolute Black
 Cocoa Bronze
 Dream White

Aluminum Top Rail

Sold in any quantity.

Architectural style, textured powder coated aluminum top rail. Featuring a design with cross member support for added strength.

6' Top Rail (70")

Item # PRTR70ABT - Absolute Black
 Item # PRTR70CBT - Cocoa Bronze
 Item # PRTR70DWT - Dream White

8' Top Rail (96-3/4")

Item # PRTR96ABT - Absolute Black
 Item # PRTR96CBT - Cocoa Bronze
 Item # PRTR96DWT - Dream White



Available in:

Absolute Black
 Cocoa Bronze
 Dream White

Top Rail Bracket - Level

Sold in any quantity.

For level top rail. Includes screws.

Item # PRLTABT - Absolute Black
 Item # PRLTBCBT - Cocoa Bronze
 Item # PRLTDWT - Dream White



Available in:

Absolute Black
 Cocoa Bronze
 Dream White

Top Rail Bracket - Stair

Sold in any quantity.

For adjustable stair rail. Adjustable up to 40 degree angle. Includes screws.

Item # PRSBTABT - Absolute Black
 Item # PRSBTCBT - Cocoa Bronze
 Item # PRSBDWT - Dream White

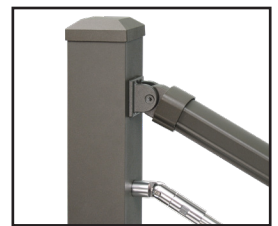

Available in:

Absolute Black
 Cocoa Bronze
 Dream White

Top Rail Bracket - Multi-Angle (Side to Side)

Sold in any quantity.

For level rail side to side. Most commonly used for 45 degree angles. Adjustable up to 53 degree angle. Includes screws.

Item # PRMATABT - Absolute Black
 Item # PRMATCBT - Cocoa Bronze
 Item # PRMATDWT - Dream White

