

RailFX® Oasis™ Cable Railing

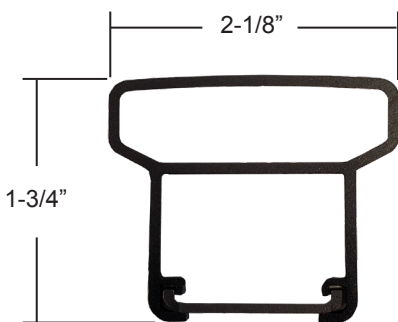

Post to Post Cable Railing System

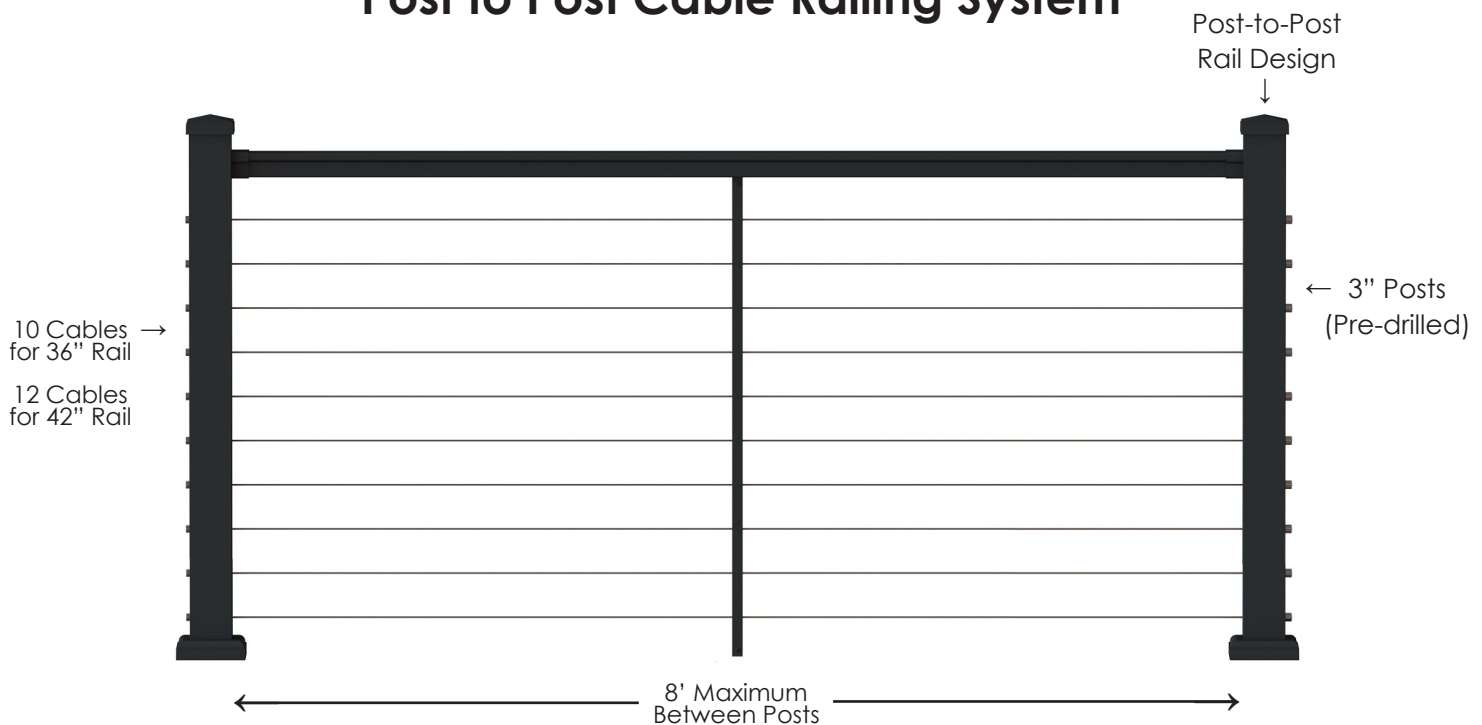

Top Rail Profile

- Post-to-Post Style
- 3" Pre-Drilled Posts - Surface Mount
- 8' Post Spacing w/ Cable Brace in the Middle
- Level Posts are Pre-Drilled for Brackets
- 10 runs of cable for 36" rail, 12 runs of cable for 42" rail
- Interior / Exterior Use
- Black Textured Powder Coat Finish

RailFX® Oasis™ Aluminum Cable Railing System

RailFX® Oasis™ cable railing system an aluminum rail with finely textured black powder coat finish. 3" Posts are all pre-drilled for cable railing and posts can be spaced up to 8' apart. RailFX® Oasis™ brings simplicity and style together, allowing you to effortlessly achieve the perfect outdoor sanctuary. Made of extruded aluminum that will never rust, it is built to withstand the test of time with minimal maintenance.

ACTUAL FREIGHT CHARGES WILL BE APPLIED TO RAILFX® ORDERS



RailFX® Oasis Cable Railing - Textured Black

DekPro™ InvisiCable for Oasis Cable Railing



InvisiCable™ Kit for Oasis

Sold in kits.

Cable railing kit made from 1/8" high quality 316 grade stainless steel. Includes 1 strand of cable with 2.75" threaded stud on one end, Pull-Lock™ fitting, washers, nut and 2 end caps.

- Item #: IC05 - 5' Cable Kit
- Item #: IC10 - 10' Cable Kit
- Item #: IC15 - 15' Cable Kit
- Item #: IC20 - 20' Cable Kit
- Item #: IC25 - 25' Cable Kit
- Item #: IC30 - 30' Cable Kit
- Item #: IC40 - 40' Cable Kit
- Item #: IC50 - 50' Cable Kit
- Item #: IC60 - 60' Cable Kit
- Item #: IC70 - 70' Cable Kit



THREADED STUD WITH
CAP, NUT AND WASHER



PULL-LOCK™ LAG

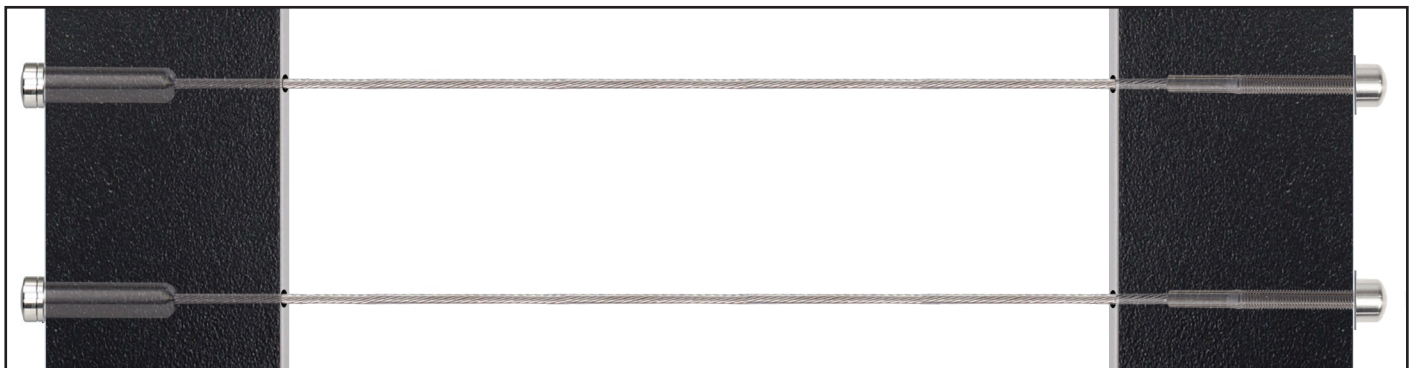

ACTUAL FREIGHT CHARGES WILL BE APPLIED TO RAILFX® ORDERS

3" RailFX® Oasis Aluminum Post - Cable



Available in:

 Textured
 Black

Oasis End Post - Pre-Drilled

Sold in any quantity.

3" Square surface mount post with pre-drilled 29/64" holes on the outside and 3/16" holes on the inside. Pre-drilled at 3-1/8" on center spacing. 10 holes for 36" rail, 12 holes for 42" rail. Pre-drilled for level brackets. Includes post cap and 1 piece skirt. 4-1/2" base plate has 3/8" holes spaced 3-3/4" on center for fasteners. Post skirt measures 5" wide.

36" Rail Height (3" x 38")

Item #: ORFX338CEPOSTTB

42" Rail Height (3" x 44")

Item #: ORFX344CEPOSTTB

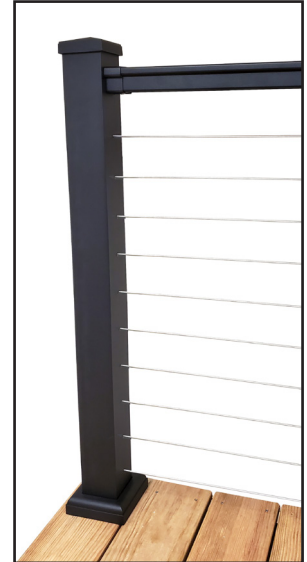

Available in:

 Textured
 Black

Oasis Intermediate Post - Pre-Drilled

Sold in any quantity.

3" Square surface mount post with pre-drilled 3/16" holes. Pre-drilled at 3-1/8" on center spacing. 10 holes for 36" rail, 12 holes for 42" rail. Pre-drilled for level brackets. Includes post cap and 1 piece skirt. 4-1/2" base plate has 3/8" holes spaced 3-3/4" on center for fasteners. Post skirt measures 5" wide.

36" Rail Height (3" x 38")

Item #: ORFX338CIPOSTTB

42" Rail Height (3" x 44")

Item #: ORFX344CIPOSTTB



ACTUAL FREIGHT CHARGES WILL BE APPLIED TO RAILFX® ORDERS

3" RailFX® Oasis Aluminum Post - Cable



Available in:

 Textured
 Black

Oasis Corner Post - Pre-Drilled

Sold in any quantity.

3" Square surface mount post with pre-drilled 1/4" holes. Pre-drilled at 3-1/8" on center spacing. 10 holes for 36" rail, 12 holes for 42" rail. Pre-drilled for level brackets. Includes post cap, 1 piece skirt and internal corner rod. 4-1/2" base plate has 3/8" holes spaced 3-3/4" on center for fasteners. Post skirt measures 5" wide.

36" Rail Height (3" x 38")

Item #: ORFX338CCPOSTB

42" Rail Height (3" x 44")

Item #: ORFX344CCPOSTB

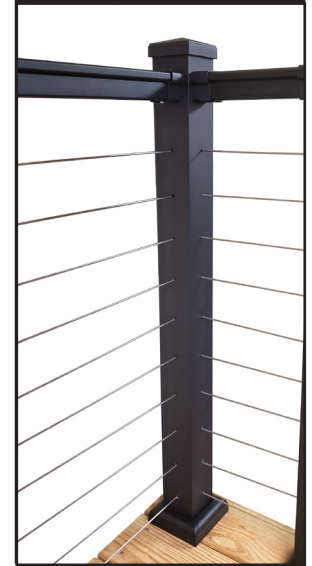

Available in:

 Textured
 Black

Oasis Stair End Post - Pre-Drilled

Sold in any quantity.

3" Square surface mount post with pre-drilled 29/64" holes on the outside and 3/16" holes on the inside. Pre-drilled at 3-1/8" on center spacing. 12 holes for 36" or 42" rail. Includes post cap, 1 piece skirt & baseplate with hardware. Base plate needs to be attached during installation. 4-1/2" base plate has 3/8" holes spaced 3-3/4" on center for fasteners. Post skirt measures 5" wide.

36" / 42" Rail Height (3" x 53")

Item #: ORFX353CSEPOSTB

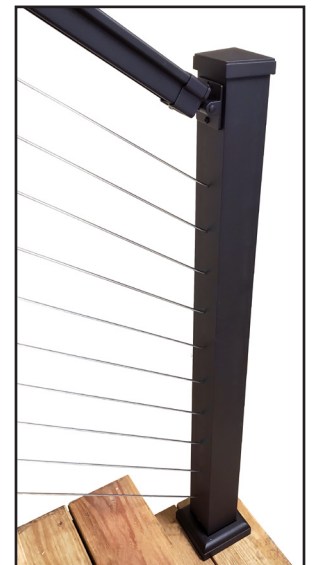

Oasis™ Aluminum Rail & Cable System ■ RailFX®

ACTUAL FREIGHT CHARGES WILL BE APPLIED TO RAILFX® ORDERS

3" RailFX® Oasis Aluminum Post - Cable

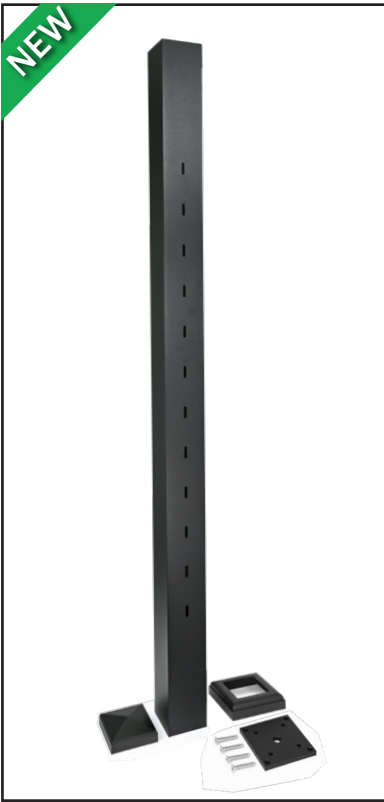

Available in:
Textured Black

Oasis Stair Intermediate Post - Pre-Drilled

Sold in any quantity.

3" Square surface mount post with pre-drilled 3/16" slotted holes to accommodate 30° - 40° stair angles. Pre-drilled at 3-1/8" on center spacing. 12 holes for 36" or 42" rail. Includes post cap, 1 piece skirt & baseplate with hardware. Base plate needs to be attached during installation. 4-1/2" base plate has 3/8" holes spaced 3-3/4" on center for fasteners. Post skirt measures 5" wide.

36" / 42" Rail Height (3" x 53")

Item #: ORFX353CSIPOSTTB



Available in:
Textured Black

DekPro™ EFEX 3" Post Cap - Upgrade

Sold in any quantity.

Optional DekPro aluminum post cap with textured finish. Available in pyramid or flat top styles with both non-lighted and lighted options. LED lights features Quick Connect wiring system for easy installation.

Item # DPPC3FABT - Flat Top
Item # DPPC3PABT - Pyramid



Available in:
Textured Black

DekPro™ EFEX 3" Lighted Post Caps

Sold in any quantity.

Optional DekPro aluminum post cap with textured finish. Available in pyramid or flat top styles with both non-lighted and lighted options. LED lights features Quick Connect wiring system for easy installation.

Item # DPPC3FDLABT - Flat Top Down Light
Item # DPPC3PDLABT - Pyramid Down Light

Item # DPPC3FBLABT - Flat Top Glow Ring
Item # DPPC3PBLABT - Pyramid Glow Ring



DekPro Quick Connect System



ACTUAL FREIGHT CHARGES WILL BE APPLIED TO RAILFX® ORDERS

Oasis Railing Top Rail Kits - Cable



Available in:
Textured
Black

8' Top Rail Kit - Level

Sold in Kits.

1 - 95" top rail, 2 top rail brackets, 1 cable brace with connectors.
Used for level rail to post attachment. Includes screws.

Item # ORFXCRK96-TXBL

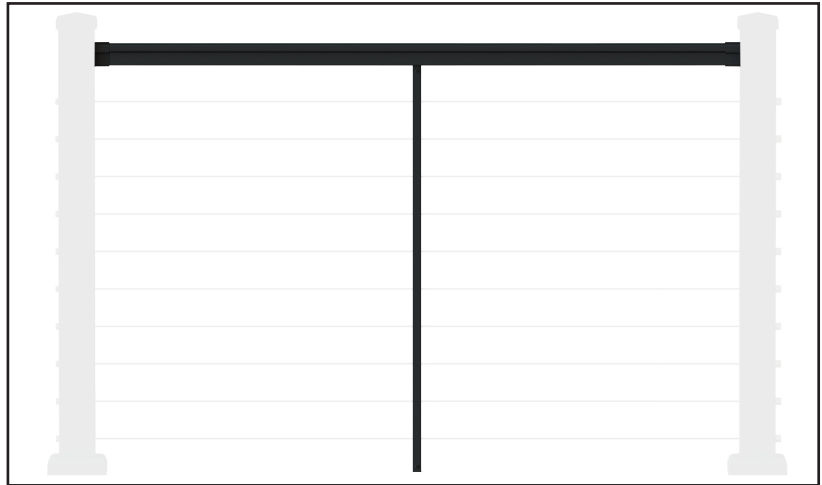

Available in:
Textured
Black

8' Top Rail Kit - Stair

Sold in kits.

1 - 95" top rail, 2 stair top rail brackets, 1 cable brace with connectors.
Used for stair rail to post attachment. Includes screws.

Item # ORFXCRSK96-TXBL

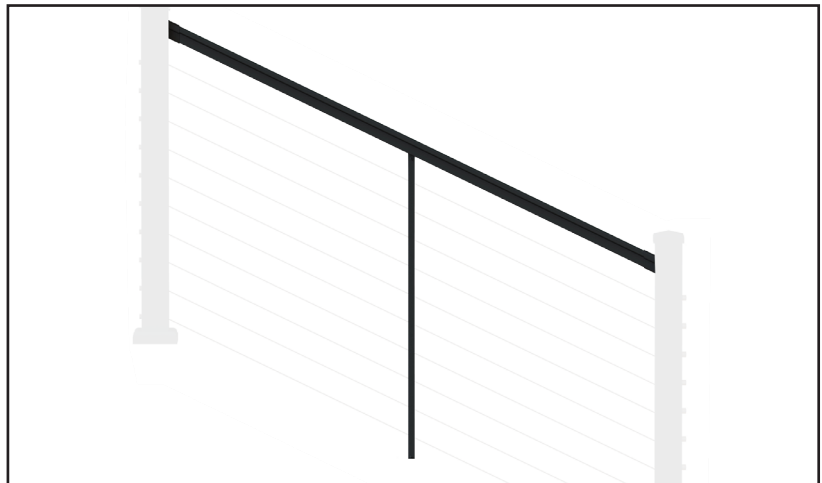

ACTUAL FREIGHT CHARGES WILL BE APPLIED TO RAILFX® ORDERS

Oasis Railing Bracket Kits - Cable



Available in:
Textured Black

Level Rail Bracket Cut Kit

Sold in Pairs.

2 top rail brackets. Used when splitting level top rail kits. Includes screws.

Item # ORFXLBKT-TXBL



Available in:
Textured Black

Stair Rail Bracket Cut Kit

Sold in Pairs.

2 top rail brackets with Stair adapter. Used when splitting stair top rail kits. Adjustable up to a 56 degree angle. Includes screws.

Item # ORFXSACRBKTKITB

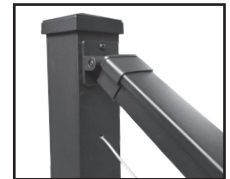

Available in:
Textured Black

Multi-Angle Adaptor Bracket

Sold in any quantity.

1 top rail multi-angle bracket adapter. Used for side to side angle rail to post attachment. **Requires a level bracket either from the rail kit or cut kit.** Adjustable up to a 49 degree angle. Includes screws.

Item # ORFXLACRBKT-TXBL



Available in:
Textured Black

Oasis Touch-Up Paint

Sold in any quantity.

Sold in .6 oz. bottle to touch up rails. Brush on application.

Item # OPFXTUPTXBL

ACTUAL FREIGHT CHARGES WILL BE APPLIED TO RAILFX[®] ORDERS



Oasis[™] Aluminum Rail & Cable System ■ RailFX[®]

RailFX® Oasis™ Picket Rail Overview



RailFX® Oasis™ Aluminum Picket Rail

RailFX® Oasis™ Picket railing system can be used with the Oasis Cable railing to value engineer the project. Cable can be ran on the “View” sides, while picket railing can be used on more discreet sides and stairs. Using picket rail in place of cable can reduce the overall cost of the project, while still allowing cable to be used on the views that matter most. See diagram below for reference.

RailFX® Oasis™ Picket is an aluminum rail with finely textured black powder coat finish. RailFX® Oasis™ brings simplicity and style together, allowing you to effortlessly achieve the perfect outdoor sanctuary. Made of extruded aluminum that will never rust, it is built to withstand the test of time with minimal maintenance.

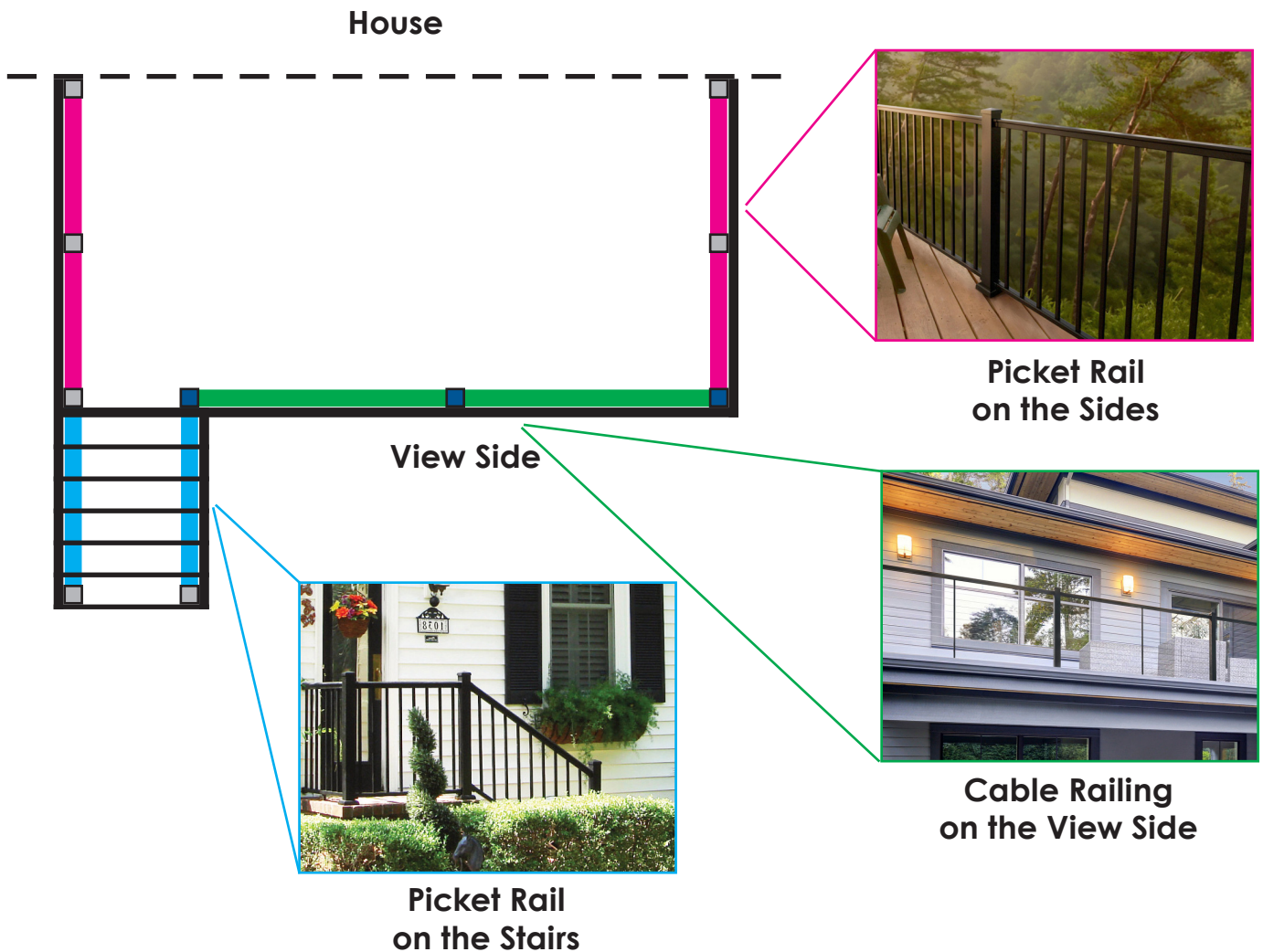

ACTUAL FREIGHT CHARGES WILL BE APPLIED TO RAILFX[®] ORDERS



RailFX[®] Oasis Level Rail - Textured Black

RailFX[®] Oasis Aluminum Railing Kits - LEVEL



Available in:
Textured Black

Oasis Aluminum Railing Kit - LEVEL Sold in any quantity.

Textured aluminum level railing comes complete with top and bottom lineals (pre-slotted for balusters), 3/4" square balusters, brackets and rail support. 33" balusters used for 36" rail, 39" balusters used for 42" rail.

6' Level Rail Kits - 71-1/2"

36" Rail Height (34" x 71-1/2")

Item # OPFXLRK636KDTXBL

42" Rail Height (40" x 71-1/2")

Item # OPFXLRK642KDTXBL

8' Level Rail Kits - 95"

36" Rail Height (34" x 95")

Item # OPFXLRK836KDTXBL

42" Rail Height (40" x 95")

Item # OPFXLRK842KDTXBL

RailFX[®] Oasis Aluminum Railing Kits - STAIR



Available in:
Textured Black

Oasis Aluminum Railing Kit - STAIR Sold in any quantity.

Textured aluminum adjustable stair railing comes complete with top and bottom lineals (pre-slotted for balusters), 3/4" square balusters, brackets and rail support. 33" balusters used for 36" rail, 39" balusters used for 42" rail.

6' Stair Rail Kits - 71-1/2"

36" Rail Height (34" x 71-1/2")

Item # OPFXSRK636KDTXBL

42" Rail Height (40" x 71-1/2")

Item # OPFXSRK642KDTXBL

8' Stair Rail Kits - 95"

36" Rail Height (34" x 95")

Item # OPFXSRK836KDTXBL

42" Rail Height (40" x 95")

Item # OPFXSRK842KDTXBL

Oasis[™] Aluminum Picket Rail System ■ RailFX[®]

ACTUAL FREIGHT CHARGES WILL BE APPLIED TO RAILFX® ORDERS

3" RailFX® Oasis Aluminum Post



Available in:
Textured Black

3" Aluminum Post w/ Post Cap and Skirt

Sold in any quantity.

3" Aluminum post with 5" welded flange. Base plate is 3/8" thick with 3/8" holes spaced 4" on center for fasteners. Post skirt measures 5" wide.
Post cap and 1 piece skirt are included.

3" x 40"

Item # OPFX338POSTXBL - Black

3" x 44"

Item # OPFX344POSTXBL - Black

3" x 54"

Item # OPFX354POSTXBL - Black



Drilling Template

Drilling Template to align railing brackets to post.

Item # OPFXDT



Available in:
Textured Black

DekPro™ EFEX 3" Post Cap - Upgrade

Sold in any quantity.

Optional DekPro aluminum post cap with textured finish. Available in pyramid or flat top styles with both non-lighted and lighted options. LED lights features Quick Connect wiring system for easy installation.

Item # DPPC3FABT - Flat Top
Item # DPPC3PABT - Pyramid



Available in:
Textured Black

DekPro™ EFEX 3" Lighted Post Caps

Sold in any quantity.

Optional DekPro aluminum post cap with textured finish. Available in pyramid or flat top styles with both non-lighted and lighted options. LED lights features Quick Connect wiring system for easy installation.

Item # DPPC3FDLABT - Flat Top Down Light
Item # DPPC3PDLABT - Pyramid Down Light

Item # DPPC3FBLABT - Flat Top Glow Ring
Item # DPPC3PBLABT - Pyramid Glow Ring



DekPro Quick Connect System



ACTUAL FREIGHT CHARGES WILL BE APPLIED TO RAILFX® ORDERS

Oasis Railing Bracket Kits



Available in:
Textured Black

Level Rail Bracket Cut Kit - Picket Rail

Sold in Kits.

2 top rail brackets, 2 bottom rail brackets and 1 support block kit. Used for level rail to post attachment. Includes screws.

Item # OPFXLBKTTXBL



Available in:
Textured Black

Stair Rail Bracket Cut Kit - Picket Rail

Sold in Kits.

2 top rail brackets, 2 bottom rail brackets and 1 support block kit. Used for side to side angle rail to post attachment. Adjustable up to a 56 degree angle. Includes screws.

Item # OPFXASBKTTXBL



Available in:
Textured Black

Multi-Angle Adaptor Bracket - Picket Rail

Sold in Pairs.

1 top and 1 bottom rail multi-angle bracket adapter. Used for side to side angle rail to post attachment. Adjustable up to a 49 degree angle. Includes screws.

Item # OPFXLABKTTXBL

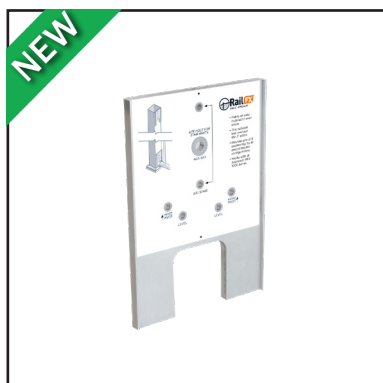

Available in:
Textured Black

Post Jig - Drilling Template - Picket Rail

Sold in Pairs.

Drilling Template to align railing brackets to post for picket rail.

Item # OPFXDT

