



26"

Available in:

- Black
- Bronze
- Ham. Bronze
- White

## 26" Round 10 Pk Aluminum Balusters

Sold in packs of 10. 10/case

26" x 3/4" Smooth satin round baluster designed for 36" rail height. Each baluster is individually poly bagged for added protection.

- Item # DP200 - Black
- Item # DP202 - Bronze
- Item # DP207 - Hammered Bronze
- Item # DP210 - White

*Use 2.67 balusters per lineal foot for estimating. (2.67 X Lineal Feet = Quantity)*



26"

Available in:

- Text. Black
- Text. Bronze
- Text. Brown

## 26" Textured Round 10 Pk Aluminum Balusters

Sold in packs of 10. 10/case

26" x 3/4" Textured round baluster designed for a 36" rail height. Each baluster is individually poly bagged for added protection.

- Item # DP200T - Textured Black
- Item # DP202T - Textured Bronze
- Item # DP205T - Textured Brown

*Use 2.67 balusters per lineal foot for estimating. (2.67 X Lineal Feet = Quantity)*



26"

Available in:

- Black
- Text. Black
- Bronze
- Ham. Bronze
- White

## 26" Round 100 Pack Aluminum Balusters

Sold in packs of 100.

26" x 3/4" Round baluster designed for 36" rail height. Balusters are packaged in 100 count contractor packs (No retail box). Each baluster is individually poly bagged for added protection.

### Smooth Finish:

- Item # DP390 - Black
- Item # DP392 - Bronze
- Item # DP393 - Hammered Bronze
- Item # DP400 - White

### Textured Finish:

- Item # DP390T - Textured Black

**PRO PACK**

*Use 2.67 balusters per lineal foot for estimating. (2.67 X Lineal Feet = Quantity)*



29"

Available in:

- Black
- Ham. Bronze

## 29" Round 100 Pack Aluminum Balusters

Sold in packs of 100.

29" x 3/4" Smooth satin round baluster designed for use in many composite rail systems. Balusters are packaged in 100 count contractor packs (No retail box). Each baluster is individually poly bagged for added protection.

- Item # DP244 - Black
- Item # DP245 - Hammered Bronze

**29" Only available in 100 packs.**

**PRO PACK**

*Use 2.67 balusters per lineal foot for estimating. (2.67 X Lineal Feet = Quantity)*



32"

Available in:

- Black
- Bronze
- Ham. Bronze
- White

### 32" Round 10 Pk Aluminum Balusters

Sold in packs of 10. 10/case

32" x 3/4" Smooth satin round baluster designed for 42" rail height. Each baluster is individually poly bagged for added protection.

- Item # DP248 - Black
- Item # DP250 - Bronze
- Item # DP255 - Hammered Bronze
- Item # DP258 - White

Use 2.67 balusters per lineal foot for estimating. (2.67 X Lineal Feet = Quantity)



32"

Available in:

- Text. Black
- Text. Bronze
- Text. Brown

### 32" Textured Round 10 Pk Aluminum Balusters

Sold in packs of 10. 10/case

32" x 3/4" Textured round baluster designed for a 42" rail height. Each baluster is individually poly bagged for added protection.

- Item # DP248T - Textured Black
- Item # DP250T - Textured Bronze
- Item # DP249T - Textured Brown

Use 2.67 balusters per lineal foot for estimating. (2.67 X Lineal Feet = Quantity)



32"

Available in:

- Black
- Text. Black
- Bronze
- Ham. Bronze

### 32" Round 100 Pack Aluminum Balusters

Sold in packs of 100.

32" x 3/4" Round baluster designed for 42" rail height. Balusters are packaged in 100 count contractor packs (No retail box). Each baluster is individually poly bagged for added protection.

#### Smooth Finish:

- Item # DP416 - Black
- Item # DP418 - Bronze
- Item # DP427 - Hammered Bronze
- Item # DP426 - White

#### Textured Finish:

- Item # DP416T - Textured Black

PRO PACK

Use 2.67 balusters per lineal foot for estimating. (2.67 X Lineal Feet = Quantity)



AAMA 2604 Powder coated balusters. Painted ends eliminate the need for a washered connector. Colors shown are an approximate representation only, please see actual product sample when selecting color

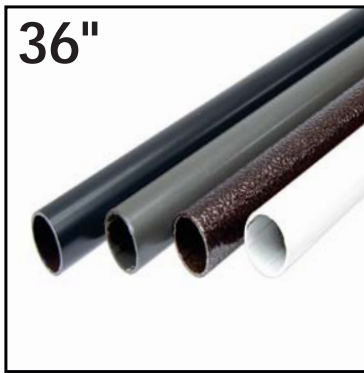

36"

Available in:

- Black
- Bronze
- Ham. Bronze
- White

### 36" Round 10 Pk Aluminum Balusters

Sold in packs of 10. 10/case

36" x 3/4" Smooth satin round baluster. Each baluster is individually poly bagged for added protection.

- Item # DP296 - Black
- Item # DP298 - Bronze
- Item # DP299 - Hammered Bronze
- Item # DP306 - White

Use 2.67 balusters per lineal foot for estimating. (2.67 X Lineal Feet = Quantity)



36"

Available in:

- Text. Black
- Text. Bronze

### 36" Textured Round 10 Pk Aluminum Balusters

Sold in packs of 10. 10/case

36" x 3/4" Textured round baluster. Each baluster is individually poly bagged for added protection.

- Item # DP296T - Textured Black
- Item # DP298T - Textured Bronze

Use 2.67 balusters per lineal foot for estimating. (2.67 X Lineal Feet = Quantity)



DekPro™ Round Balusters w/ Architectural Connectors, EFFEX Plateau Post Caps and 2x4 Rail Connectors - Black



Available in:  
 Black

## Baluster Connector for Round or Square

Sold in poly bag of 20. 50/case

For 3/4" round or square balusters. Features a tall hidden connector that assures positive engagement for a secure connection. Includes 1-1/2" stainless steel screws. **Enough for 10 Balusters.**

Item # DP374 - Hidden Connector

*See next page for contractor pro packs and baluster connector layout template*



Available in:  
 Black  
 Bronze  
 Ham. Bronze  
 White

## Round Baluster Stair Connector

Sold in poly bag of 20. 40/case

For 3/4" round balusters being used on stairs with 33-37 degree angle. Features a tall hidden connector that assures positive engagement for a secure connection. Includes 1-1/2" stainless steel screws. **Enough for 10 Balusters.**

Item # DP380 - Black  
 Item # DP380BZ - Bronze  
 Item # DP380HB - Hammered Bronze  
 Item # DP380WH - White



Available in:  
 Black  
 Bronze  
 White

## Architectural Round Baluster Connector

Sold in poly bag of 20. 30/case

Level connector for 3/4" round balusters. Features a decorative architectural design. Measures 1-3/8" in diameter, 1/2" height. Includes 1-1/2" stainless steel screws. **Enough for 10 Balusters.**

Item # DP140 - Black  
 Item # DP144 - Bronze  
 Item # DP142 - White

*See next page for baluster connector layout template*



Available in:  
 Black  
 Bronze  
 White

## Architectural Stair Round Baluster Connector

Sold in poly bag of 20. 10/case

One piece stair connector for 3/4" round balusters being used on stairs with 33-37 degree angle. Features a decorative architectural design. Measures 1-5/8" L x 1-3/8" W. Includes 1-1/2" stainless steel screws. **Enough for 10 Balusters.**

Item # DP146 - Black  
 Item # DP150 - Bronze  
 Item # DP148 - White





Available in:  
Black

## 5° Round Baluster Connector for Ramps

Sold in poly bag of 20. 40/case

Five degree connector for 3/4" round balusters in a ramp application. Features a tall connector that assures positive engagement for a secure connection. Includes 1-1/2" stainless steel screws.  
**Enough for 10 Balusters.**

Item # DP770 - Black



## Universal Baluster Connector Pro Pack - 500 ct.

Sold in Pails.

Fits most 3/4" diameter balusters in the market today. Contractor pail contains 500 connectors and 1-1/2" #2 square drive stainless steel screws. Eliminates packaging hassles for the professional deck builder and enables them to do two - three average decks per pail. Screws bagged separately for convenience.  
**Enough for 250 Balusters.**

Item # ADIPROPACK500BP

Item # ADIPROPACK500 - Same as round baluster connector above, but with attached washer. For use with balusters when ends are not powder coated.



Available in:  
Black

## U-Ball Connector

Sold in packs of 50.

Universal connector for 3/4" square or round balusters. Features a round hidden connector that allows for a secure connection at varying angles. Excellent for odd angle applications. Requires baluster to be cut if at an angle on both ends. Includes 1-1/2" stainless steel screws.

Item #: UBALL

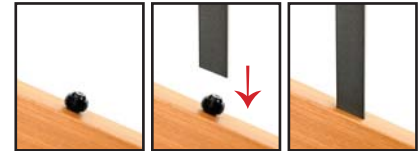

## Universal Baluster Spacing Template - 48"

Sold in any quantity.

Spaces balusters at 4-1/2" **on center** to meet railing code. Allows for even spacing of DekPro<sup>™</sup> round, square and architectural baluster connectors. Round and square connectors fit into template, for architectural connectors use small hole to locate. Shift template progressively down the lineal for longer length railings.

Item # DPBALUSTERTEMP - 48" Length PVC Template

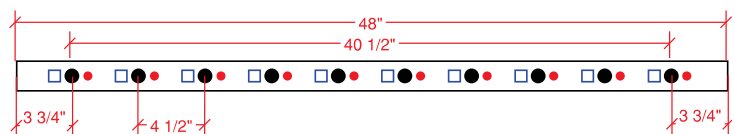



Available in:

Black

Bronze

Cedar

## 2" x 4" Railing Connector

Sold in packs of 2. 25/case

2" x 4" Straight rail connector for attaching upper and lower rail to post. 1" deep saddle provides great strength and holding power. Includes color matched stainless steel screws.

Item # DP375 - Black  
Item # DP375BZ - Bronze  
Item # DP375C - Cedar

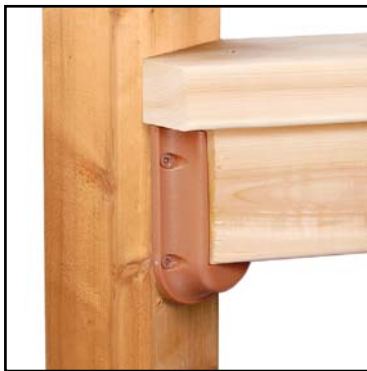

Available in:

Black

Bronze

Cedar

## 2" x 4" 45° Railing Connector

Sold in packs of 2. 25/case

2" x 4" 45° Rail connector with design, style and flair for attaching upper and lower rail to post at a typical 45° angle. 1" deep saddle provides great strength and holding power. Includes color matched stainless steel screws. (Requires slight trimming of 2" x 4" lineal)

Item # DP389 - Black  
Item # DP389BZ - Bronze  
Item # DP389C - Cedar



Available in:

Black

Bronze

Cedar

## 2" x 4" Stair Railing Connector

Sold in packs of 2. 20/case

2" x 4" Stair rail connector with design, style and flair for attaching upper and lower rail to post at a typical stair angle. 1" deep saddle provides great strength and holding power. Includes color matched stainless steel screws.

Item # DP388 - Black  
Item # DP388BZ - Bronze  
Item # DP388C - Cedar



DekPro™ 2x4 Railing Connectors, EFFEX Plateau Post Caps, and Round Balusters w/ Architectural Connectors -Black

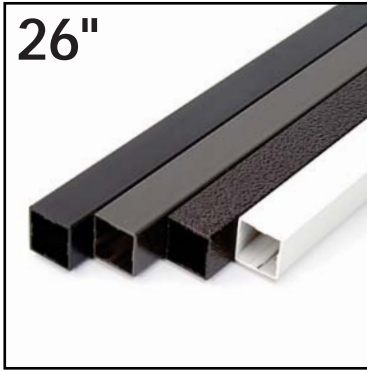

Available in:

- Black
- Bronze
- Ham. Bronze
- White

## 26" Square 10 Pk Aluminum Balusters

Sold in packs of 10. 10/case

26" x 3/4" Smooth satin square baluster designed for 36" rail height. Each baluster is individually poly bagged for added protection.

- Item # DP212 - Black
- Item # DP214 - Bronze
- Item # DP219 - Hammered Bronze
- Item # DP222 - White

Use 2.67 balusters per lineal foot for estimating. (2.67 X Lineal Feet = Quantity)

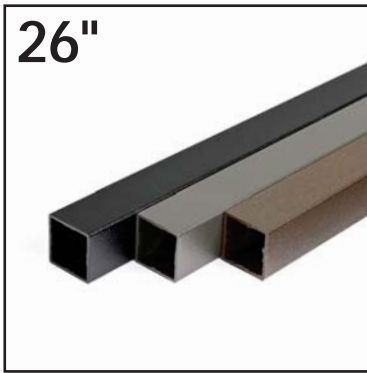

Available in:

- Text. Black
- Text. Bronze
- Text. Brown

## 26" Textured Square 10 Pk Aluminum Balusters

Sold in packs of 10. 10/case

26" x 3/4" Textured square baluster designed for a 36" rail height. Each baluster is individually poly bagged for added protection.

- Item # DP212T - Textured Black
- Item # DP214T - Textured Bronze
- Item # DP213T - Textured Brown

Use 2.67 balusters per lineal foot for estimating. (2.67 X Lineal Feet = Quantity)

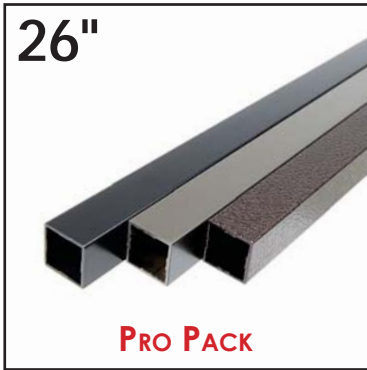

Available in:

- Black
- Bronze
- Ham. Bronze

## 26" Square 100 Pack Aluminum Balusters

Sold in packs of 100.

26" x 3/4" Smooth satin square baluster designed for 36" rail height. Balusters are packaged in 100 count contractor packs (No retail box). Each baluster is individually poly bagged for added protection.

- Item # DP402 - Black
- Item # DP404 - Bronze
- Item # DP403 - Hammered Bronze

Use 2.67 balusters per lineal foot for estimating. (2.67 X Lineal Feet = Quantity)



Available in:

- Black
- Ham. Bronze

## 29" Square 100 Pack Aluminum Balusters

Sold in packs of 100.

29" x 3/4" Smooth satin square baluster designed for use in many composite rail systems. Balusters are packaged in 100 count contractor packs (No retail box). Each baluster is individually poly bagged for added protection.

- Item # DP246 - Black
- Item # DP247 - Hammered Bronze

29" Only available in 100 packs.

Use 2.67 balusters per lineal foot for estimating. (2.67 X Lineal Feet = Quantity)

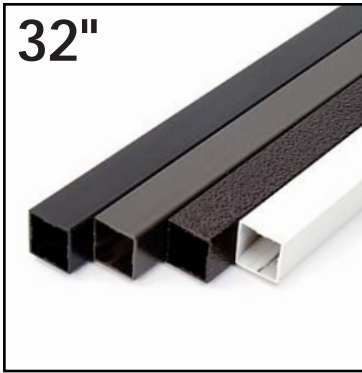

- Available in:
- Black
  - Bronze
  - Ham. Bronze
  - White

### 32" Square 10 Pk Aluminum Balusters

Sold in packs of 10. 10/case

32" x 3/4" Smooth satin square baluster designed for 42" rail height. Each baluster is individually poly bagged for added protection.

- Item # DP260 - Black
- Item # DP262 - Bronze
- Item # DP267 - Hammered Bronze
- Item # DP261 - White

Use 2.67 balusters per lineal foot for estimating. (2.67 X Lineal Feet = Quantity)

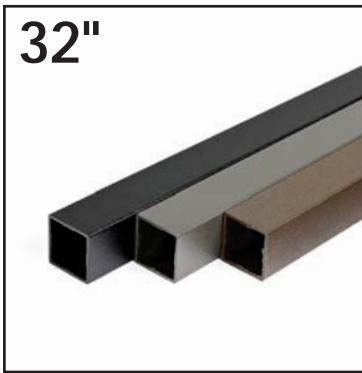

- Available in:
- Text. Black
  - Text. Bronze
  - Text. Brown

### 32" Textured Square 10 Pk Aluminum Balusters

Sold in packs of 10. 10/case

32" x 3/4" Textured square baluster designed for a 42" rail height. Each baluster is individually poly bagged for added protection.

- Item # DP260T - Textured Black
- Item # DP262T - Textured Bronze
- Item # DP263T - Textured Brown

Use 2.67 balusters per lineal foot for estimating. (2.67 X Lineal Feet = Quantity)



- Available in:
- Black
  - Bronze
  - Ham. Bronze

### 32" Square 100 Pack Aluminum Balusters

Sold in packs of 100.

32" x 3/4" Smooth satin square baluster designed for 42" rail height. Balusters are packaged in 100 count contractor packs (No retail box). Each baluster is individually poly bagged for added protection.

- Item # DP428 - Black
- Item # DP430 - Bronze
- Item # DP432 - Hammered Bronze

Use 2.67 balusters per lineal foot for estimating. (2.67 X Lineal Feet = Quantity)

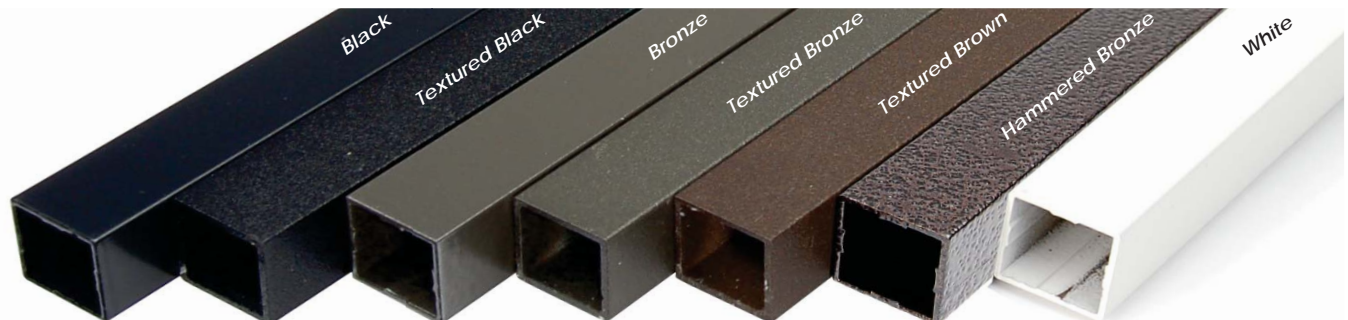

AAMA 2604 Powder coated balusters. Painted ends eliminate the need for a washered connector. Colors shown are an approximate representation only, please see actual product sample when selecting color



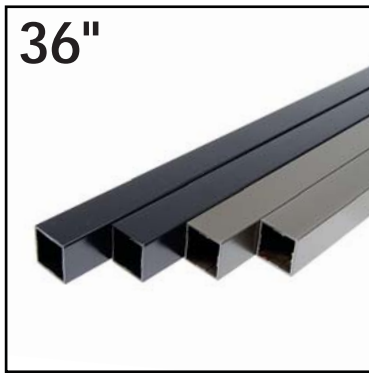

Available in:  
Black  
Bronze

### 36" Square 10 Pk Aluminum Balusters

Sold in packs of 10. 10/case

36" x 3/4" Smooth satin square baluster. Each baluster is individually poly bagged for added protection.

Item # DP308 - Black  
Item # DP310 - Bronze

Use 2.67 balusters per lineal foot for estimating. (2.67 X Lineal Feet = Quantity)

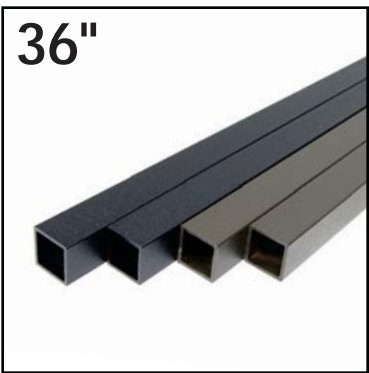

Available in:  
Text. Black  
Text. Bronze

### 36" Textured Square 10 Pk Aluminum Balusters

Sold in packs of 10. 10/case

36" x 3/4" Textured square baluster. Each baluster is individually poly bagged for added protection.

Item # DP308T - Textured Black  
Item # DP310T - Textured Bronze

Use 2.67 balusters per lineal foot for estimating. (2.67 X Lineal Feet = Quantity)

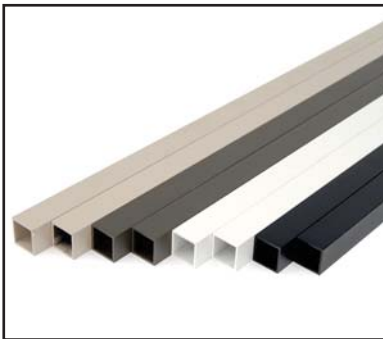

Available in:  
Absolute Black  
Cocoa Bronze  
Dream White  
Maple Cream

### 48" Textured Square Aluminum Baluster - Each

Sold in any quantity.

48" x 3/4" Textured square baluster. Sold Individually.

#### 48" Baluster:

Item # PR48SABT - Absolute Black  
Item # PR48SCBT - Cocoa Bronze  
Item # PR48SDWT - Dream White  
Item # PR48SMCT - Maple Cream

Use 2.67 balusters per lineal foot for estimating. (2.67 X Lineal Feet = Quantity)

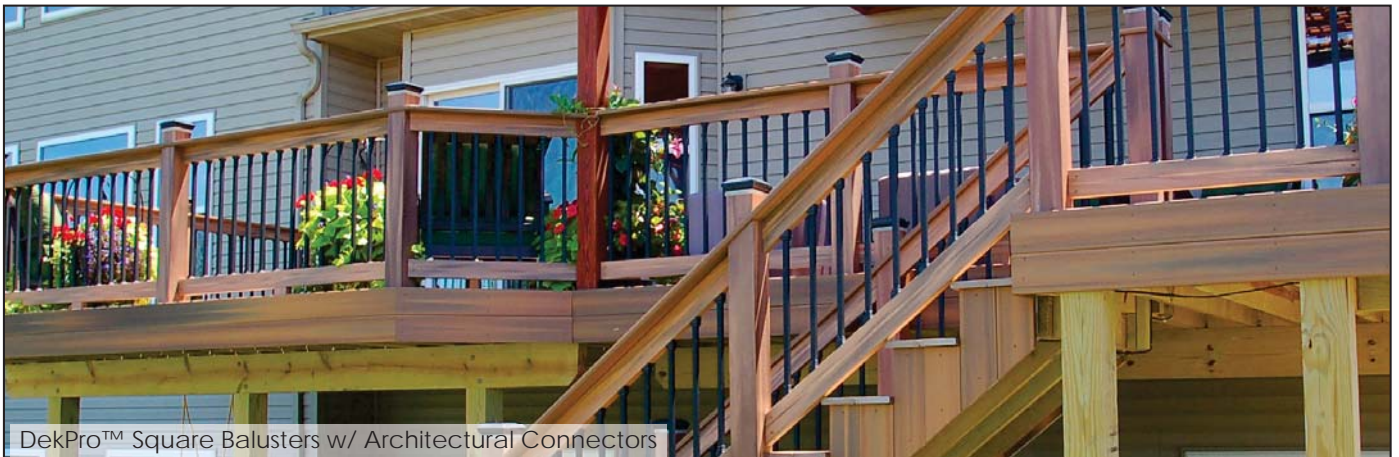

DekPro™ Square Balusters w/ Architectural Connectors



Available in:  
Black

## Baluster Connector for Square or Round

Sold in poly bag of 20. 50/case

For 3/4" square or round balusters. Features a tall hidden connector that assures positive engagement for a secure connection. Includes 1-1/2" stainless steel screws. **Enough for 10 Balusters.**

Item # DP374 - Hidden Connector

*See next page for baluster connector layout template*



Available in:  
Black

## Square Baluster Connector

Sold in poly bag of 20. 50/case

For 3/4" square balusters. Features a tall connector that assures positive engagement for a secure connection. Also has anti-rotation spike on bottom of connector. Includes 1-1/2" stainless steel screws. **Enough for 10 Balusters.**

Item # DP376 - Black

*See next page for baluster connector layout template*



Available in:  
Black  
Bronze  
Ham. Bronze  
White

## Square Baluster Stair Connector

Sold in poly bag of 20. 35/case

For 3/4" square balusters being used on stairs with 33-37 degree angle. Features a tall connector that assures positive engagement for a secure connection. Includes 1-1/2" stainless steel screws. **Enough for 10 Balusters.**

Item # DP377 - Black  
Item # DP377BZ - Bronze  
Item # DP377HB - Hammered Bronze  
Item # DP377WH - White

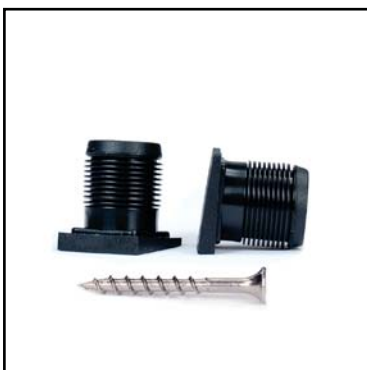

Available in:  
Black

## 5° Square Baluster Connector for Ramps

Sold in poly bag of 20. 40/case

Five degree connector for 3/4" square balusters in a ramp application. Features a tall connector that assures positive engagement for a secure connection. Includes 1-1/2" stainless steel screws. **Enough for 10 Balusters.**

Item # DP773 - Black



Available in:  
 Black  
 Bronze  
 White

## Architectural Square Baluster Connector

Sold in poly bag of 20. 20/case

Level connector for 3/4" square balusters. Features a decorative architectural design. Also has anti-rotation spike on bottom of connector. Measures 1-3/8" square, 1/2" height. Includes 1-1/2" stainless steel screws.

Enough for 10 Balusters.

Item # DP152 - Black  
 Item # DP156 - Bronze  
 Item # DP154 - White



See below for baluster connector layout template



Available in:  
 Black  
 Bronze  
 White

## Architectural Stair Square Baluster Connector

Sold in poly bag of 20. 10/case

One piece stair connector for 3/4" square balusters being used on stairs with 33-37 degree angle. Features a decorative architectural design. Measures 1-5/8" L x 1-3/8" W. Includes 1-1/2" stainless steel screws.

Enough for 10 Balusters.

Item # DP158 - Black  
 Item # DP162 - Bronze  
 Item # DP160 - White



Available in:  
 Black

## U-Ball Connector

Sold in packs of 50.

Universal connector for 3/4" square or round balusters. Features a round hidden connector that allows for a secure connection at varying angles. Excellent for odd angle applications. Requires baluster to be cut if at an angle on both ends. Includes 1-1/2" stainless steel screws.

Enough for 25 Balusters.

Item #: UBALL

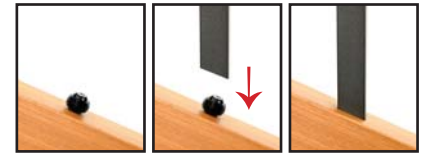

## Universal Baluster Spacing Template - 48"

Sold in any quantity.

Spaces balusters at 4-1/2" on center to meet railing code. Allows for even spacing of DekPro™ round, square and architectural baluster connectors. Round and square connectors fit into template, for architectural connectors use small hole to locate. Shift template progressively down the lineal for longer length railings.

Item # DPBALUSTERTEMP - 48" Length PVC Template

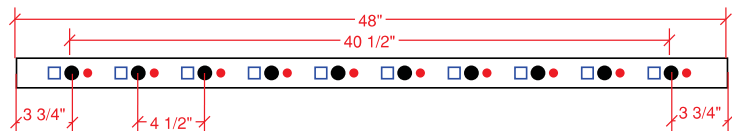



Available in:

Black

Bronze

Cedar

## 2" x 4" Railing Connector

Sold in packs of 2. 25/case

2" x 4" Straight rail connector for attaching upper and lower rail to post. 1" deep saddle provides great strength and holding power. Includes color matched stainless steel screws.

Item # DP375 - Black  
Item # DP375BZ - Bronze  
Item # DP375C - Cedar

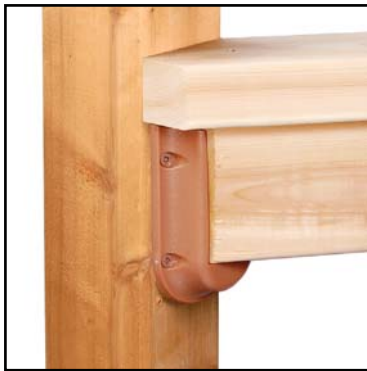

Available in:

Black

Bronze

Cedar

## 2" x 4" 45° Railing Connector

Sold in packs of 2. 25/case

2" x 4" 45° Rail connector with design, style and flair for attaching upper and lower rail to post at a typical 45° angle. 1" deep saddle provides great strength and holding power. Includes color matched stainless steel screws. (Requires slight trimming of 2" x 4" lineal)

Item # DP389 - Black  
Item # DP389BZ - Bronze  
Item # DP389C - Cedar



Available in:

Black

Bronze

Cedar

## 2" x 4" Stair Railing Connector

Sold in packs of 2. 20/case

2" x 4" Stair rail connector with design, style and flair for attaching upper and lower rail to post at a typical stair angle. 1" deep saddle provides great strength and holding power. Includes color matched stainless steel screws.

Item # DP388 - Black  
Item # DP388BZ - Bronze  
Item # DP388C - Cedar



DekPro™ 2x4 Railing Connectors, EFFEX Plateau Post Caps, and Round Balusters w/ Architectural Connectors -Black



Available in:

- Black
- Textured Black
- Bronze
- Textured Bronze
- Ham. Bronze



## 32" Belly (Baroque) Style Baluster 5 Pack

Sold in packs of 5. 10/case

32" Belly style baluster measures 3/16" x 1" x 32-1/4."

Each package contains color matched stainless steel screws.

### Smooth Finish:

- Item # DP346 - Black
- Item # DP348 - Bronze
- Item # DP350 - Hammered Bronze

### Textured Finish:

- Item # DP346T - Text. Black
- Item # DP348T - Text. Bronze

Use 2.5 balusters per lineal foot for estimating. (2.5 X Lineal Feet = Quantity)



Available in:

- Black



## 32" Belly (Baroque) Style Baluster 50 Pack

Sold in packs of 50.

32" Belly style baluster measures 3/16" x 1" x 32-1/4." Balusters are packaged in 50 count contractor packs (No retail box).

Each package contains color matched stainless steel screws.



- Item # DP347 - Black

Use 2.5 balusters per lineal foot for estimating. (2.5 X Lineal Feet = Quantity)



DekPro<sup>™</sup> Belly Balusters, 2x4 Rail Connectors and EFFEX Summit Post Caps - Black

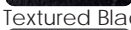
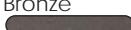

Available in:  
 Black  
 Textured Black  
 Bronze  
 Textured Bronze  
 Ham. Bronze



### 32" Bow (Arc) Style Baluster 5 Pack

Sold in packs of 5. 10/case

32" Bow style baluster measures 3/16" x 1" x 32-1/4."  
Each package contains color matched stainless steel screws.

**Smooth Finish:**

- Item # DP358 - Black
- Item # DP360 - Bronze
- Item # DP362 - Hammered Bronze

**Textured Finish:**

- Item # DP358T - Text. Black
- Item # DP360T - Text. Bronze

Use 2.5 balusters per lineal foot for estimating. (2.5 X Lineal Feet = Quantity)



Available in:  
 Black



### 32" Bow (Arc) Style Baluster 50 Pack

Sold in packs of 50.

32" Bow style baluster measures 3/16" x 1" x 32-1/4." Balusters are packaged in 50 count contractor packs (No retail box). Each package contains color matched stainless steel screws.

- Item # DP359 - Black

Use 2.5 balusters per lineal foot for estimating. (2.5 X Lineal Feet = Quantity)



DekPro<sup>TM</sup> Bow Balusters, 2x4 Rail Connectors and EFFEX Summit Post Caps - Bronze



Available in:

- Black
- Textured Black
- Bronze
- Textured Bronze
- Ham. Bronze



### 32" Face Mount Baluster 10 Pack (Traditional)

Sold in packs of 10. 10/case

Face mount rectangular baluster measures 1/2" x 1" x 32-1/4". Each package contains color matched stainless steel screws and plastic end caps.

**Smooth Finish:**

- Item # DP464 - Black
- Item # DP466 - Bronze
- Item # DP468 - Hammered Bronze

**Textured Finish:**

- Item # DP464T - Text. Black
- Item # DP466T - Text. Bronze

Use 2.5 balusters per lineal foot for estimating. (2.5 X Lineal Feet = Quantity)



Available in:

- Black



### 32" Face Mount Baluster - 100 Pack (Traditional)

Sold in packs of 100.

Face mount balusters are packaged in 100 count contractor packs (No retail box). Each package contains color matched stainless steel screws and plastic end caps.

- Item # DP465 - Black

Use 2.5 balusters per lineal foot for estimating. (2.5 X Lineal Feet = Quantity)



Available in:

- Black
- Bronze



### 38" Face Mount Baluster 10 Pack (Traditional)

Sold in packs of 10. 10/case

Face mount rectangular baluster measures 1/2" x 1" x 38-1/4". Each package contains color matched stainless steel screws and plastic end caps.

- Item # DP332 - Black
- Item # DP334 - Bronze

Use 2.5 balusters per lineal foot for estimating. (2.5 X Lineal Feet = Quantity)



DekPro<sup>™</sup> Face mount Balusters, 2x4 Rail Connectors and EFFEX Summit Post Caps - Bronze



Available in:  
 Clear

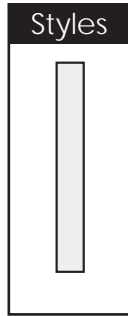

## 26" & 32" Glass Balusters 5 Pack

Sold in packs of 5. 3/case

Tempered glass measures 5/16" thick x 4" wide X 26" or 32" long, will work for many different rail heights.

Requires glass rail connector shown below. Sold separately.

Item # DP370 - 26" length  
 Item # DP372 - 32" length

Use 1.5 balusters per lineal foot for estimating. (1.5 X Lineal Feet = Quantity)



Available in:  
 Clear

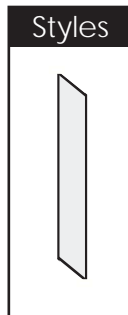

## 26" & 32" Stair Glass Balusters 5 Pack

Sold in packs of 5. 3/case

Tempered glass for stair measures 5/16" thick x 4" wide x 25-1/2", or 32-1/4" long, will work for stair angles from 34 - 36 degrees.

Requires glass stair rail connector shown below. Sold separately.

Item # DP382 - 25-1/2" length  
 Item # DP384 - 32-1/4" length

Use 1.5 balusters per lineal foot for estimating. (1.5 X Lineal Feet = Quantity)



Available in:  
 Black  
 Bronze  
 White

## Straight Glass Baluster Connector

Sold in packs of 2. 50/case

Glass baluster connector featuring hidden internal fasteners.

Connectors increase overall baluster height by 3/4".

Includes 1-1/2" stainless steel screws. Enough for 1 glass baluster.

Item # DP381 - Black  
 Item # DP381BZ - Bronze  
 Item # DP381WH - White



Available in:  
 Black  
 Bronze  
 White

## Stair Glass Baluster Connector

Sold in packs of 2. 50/case

Glass baluster connector featuring hidden internal fasteners. Connectors increase overall baluster height by 3/4" and can be used with glass stair baluster installations. Includes 1-1/2" stainless steel screws. Compatible with common stair angles from 34-36 degrees. Enough for 1 glass baluster.

Item # DP387 - Black  
 Item # DP387BZ - Bronze  
 Item # DP387WH - White







Available in:

Black

Bronze

Cedar

## 2" x 4" Railing Connector

Sold in packs of 2. 25/case

2" x 4" Straight rail connector for attaching upper and lower rail to post. 1" deep saddle provides great strength and holding power. Includes color matched stainless steel screws.

Item # DP375 - Black  
Item # DP375BZ - Bronze  
Item # DP375C - Cedar



Available in:

Black

Bronze

Cedar

## 2" x 4" 45° Railing Connector

Sold in packs of 2. 25/case

2" x 4" 45° Rail connector with design, style and flair for attaching upper and lower rail to post at a typical 45° angle. 1" deep saddle provides great strength and holding power. Includes color matched stainless steel screws. (Requires slight trimming of 2" x 4" lineal)

Item # DP389 - Black  
Item # DP389BZ - Bronze  
Item # DP389C - Cedar



Available in:

Black

Bronze

Cedar

## 2" x 4" Stair Railing Connector

Sold in packs of 2. 20/case

2" x 4" Stair rail connector with design, style and flair for attaching upper and lower rail to post at a typical stair angle. 1" deep saddle provides great strength and holding power. Includes color matched stainless steel screws.

Item # DP388 - Black  
Item # DP388BZ - Bronze  
Item # DP388C - Cedar



## Universal Baluster Spacing Template - 48"

Sold in any quantity.

Spaces balusters at 4-1/2" on center to meet railing code. Allows for even spacing of DekPro™ round, square and architectural baluster connectors. Round and square connectors fit into template, for architectural connectors use small hole to locate. Shift template progressively down the lineal for longer length railings.

Item # DPBALUSTERTEMP - 48" Length PVC Template

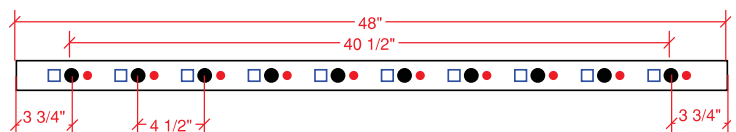



Available in:  
  
 Bronze

### Aluminum Round Basket

Sold in any quantity. 24/case

Baskets designed to slide over round balusters and lock in place with 3/32 allen set screws (Included). Measures 2-1/2" W X 4-1/2" H.

Item # DP502 - Bronze



Available in:  
  
 Bronze



### Solid Aluminum Round Collar

Sold in any quantity. 25/case

Collars designed to slide over round balusters and lock in place with 3/32 allen set screws (Included). Measures 1-5/8" W X 1-7/8" H.

Item # DP530 - Bronze



Available in:  
  
 Black  
  
 Bronze



### Aluminum Square Basket

Sold in any quantity. 24/case

Baskets designed to slide over square balusters and lock in place with 3/32 allen set screw (Included). Measures 2-3/4" W X 4-5/8" H.

Item # DP514 - Black



Available in:  
  
 Black  
  
 Bronze

### Solid Aluminum Square Collar

Sold in any quantity. 25/case

Collars designed to slide over square balusters and lock in place with 3/32 allen set screw (Included). Measures 1-5/8" W X 1-7/8" H.

Item # DP556 - Black  
 Item # DP558 - Bronze



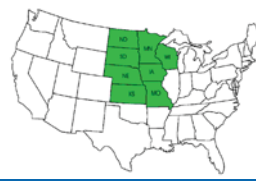

**ACTUAL FREIGHT CHARGES APPLY TO FORTRESS® BALUSTER ORDERS**



**31"**

Available in:

- Black Sand
- Gloss Black

Styles

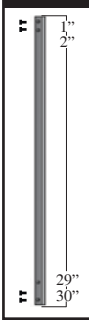

**31" Vintage Iron Square Baluster**  
**Face Mount**

Sold in packs of 10. 4/case

31" x 5/8" Vintage series square baluster for face mount installation to achieve a total railing height of 36". Screws included.

- Item # 54131018 - Black Sand (Textured)
- Item # 660100 - Gloss Black

Use 2.67 balusters per lineal foot for estimating. (2.67 X Lineal Feet = Quantity)

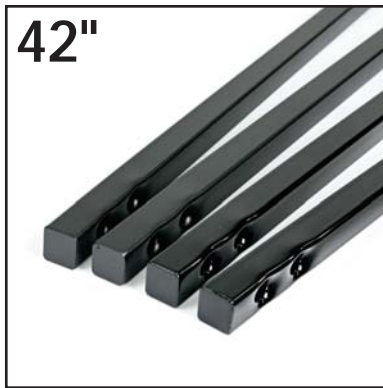

**42"**

Available in:

- Black Sand
- Gloss Black

Styles

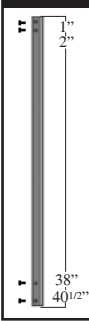

**42" Vintage Iron Square Baluster**  
**Face Mount**

Sold in packs of 10. 4/case

42" x 5/8" Vintage series square baluster for face mount installation to achieve a total railing height of 36" when attached to fascia. Screws included.

- Item # 54142018 - Black Sand (Textured)
- Item # 660200 - Gloss Black

Use 2.67 balusters per lineal foot for estimating. (2.67 X Lineal Feet = Quantity)

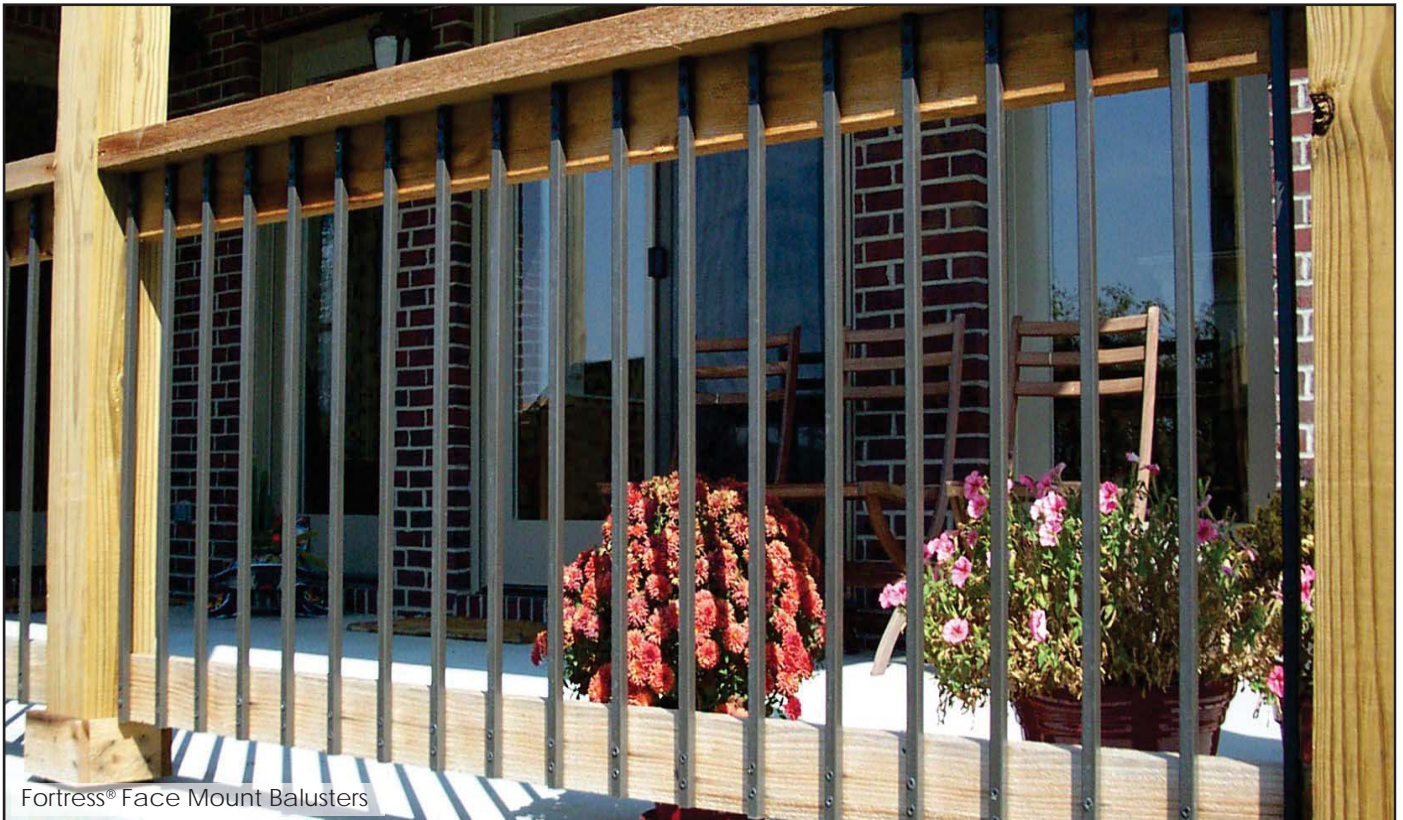

Fortress® Face Mount Balusters

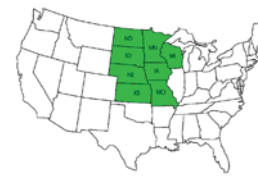

**ACTUAL FREIGHT CHARGES APPLY TO FORTRESS® BALUSTER ORDERS**

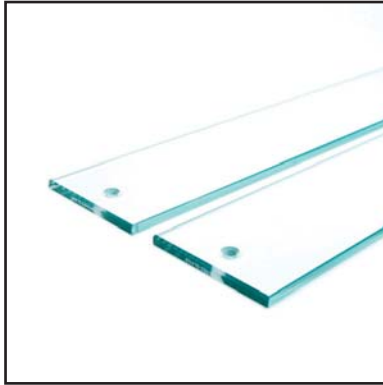

Available in:  
Clear



**26" & 34" Pure View® Glass - Standard**

Sold in packs of 5. 3/case

26" & 34" Pure View 5/16" tempered glass balusters that are 3-3/4" wide for straight installations. Fasteners not included.

- Item # 660500 - 26" length
- Item # 660520 - 34" length
- Item # 650032 - Screws with Washer (10/bag)

Use 1.5 balusters per lineal foot for estimating. (1.5 X Lineal Feet = Quantity)



Available in:  
Clear



**26" & 34" Pure View® Glass - Stairs**

Sold in packs of 5. 3/case

26" & 34" Pure View 5/16" tempered glass balusters that are 3-3/4" wide for stair installations. Fasteners not included.

- Item # 660510 - 26" length
- Item # 660530 - 34" length
- Item # 650032 - Screws with Washer (10/bag)

Use 1.5 balusters per lineal foot for estimating. (1.5 X Lineal Feet = Quantity)



Available in:  
Black

**Pure View® Nylon Mounting Shoe - Standard**

Sold in bags of 10. 20/case

Pure View nylon mounting shoe is used for surface mount installation of Pure View glass balusters for straight applications. Screws included.  
Enough for 5 glass balusters.

Item # 660685



Available in:  
Black

**Pure View® Nylon Mounting Shoe - Stairs**

Sold in bags of 10. 20/case

Pure View nylon mounting shoe is used for surface mount installation of Pure View glass balusters for stair applications. Compatible for stair angles between 25-37 degrees. Screws included.  
Enough for 5 glass balusters.

Item # 660687



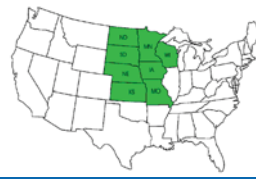

**ACTUAL FREIGHT CHARGES APPLY TO FORTRESS® BALUSTER ORDERS**



Available in:  
Black

**Pure View® Screw & Washer**

Sold in bags of 10.

Pure View screw & washer for sandwich method installation of Pure View glass balusters for straight and stair applications. Screws are ordered separately. Includes enough screws to do 5 glass balusters.

Item # 650032

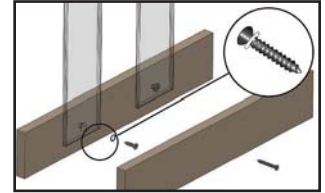

Fortress® Glass Balusters



Fortress® Glass Balusters